



POCKEY 3 IN 1 GAME TABLE



Replacement Parts

Order direct at www.gldproducts.com
or call our Customer Service department at
(800) 225-7593
8 am to 4:30 pm Central Standard Time

Staple your receipt here.

Important: A copy of your receipt will be needed to activate your warranty (see page 16).

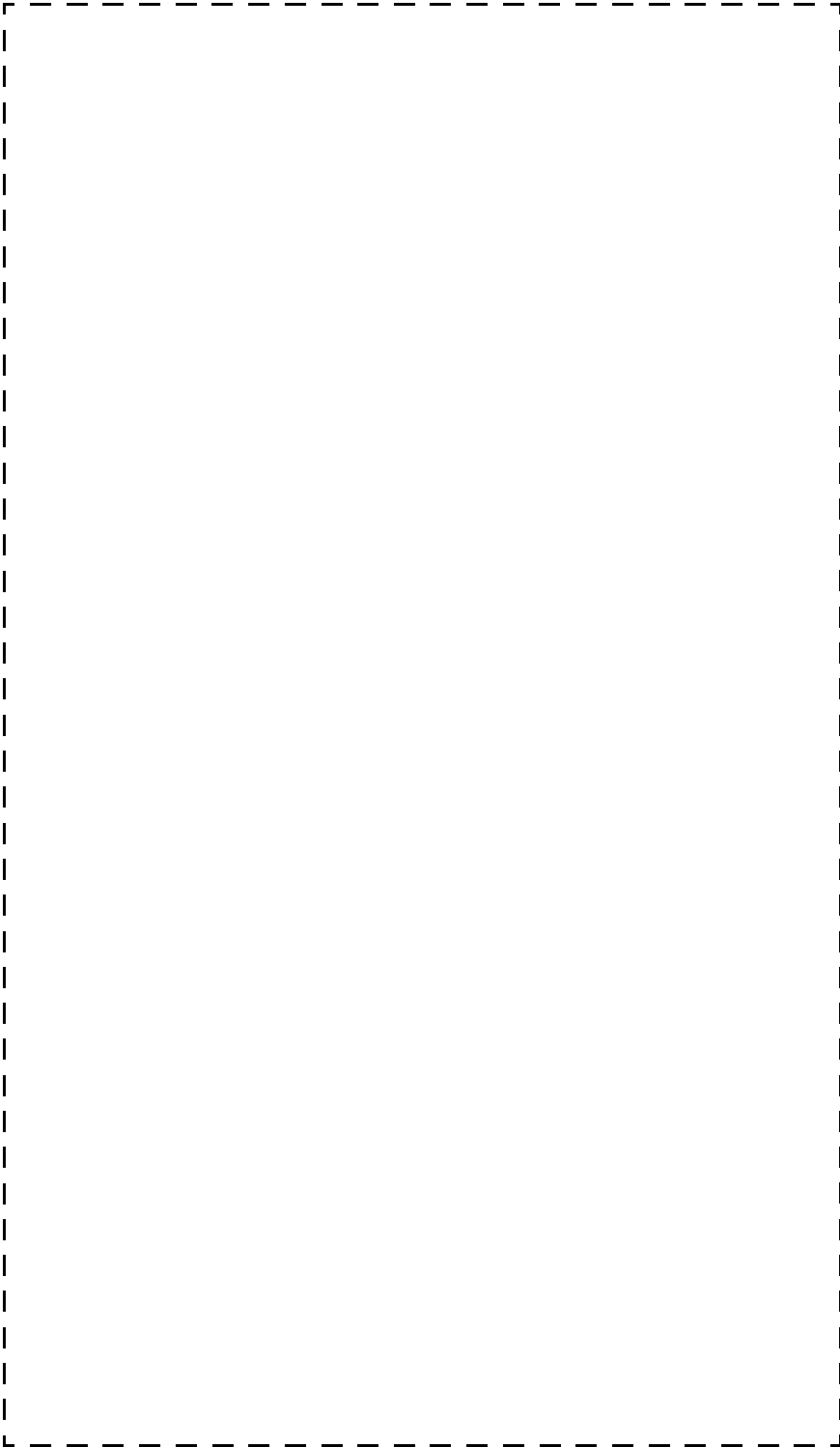



Congratulations and THANK YOU for purchasing the Pockey 3 in 1 Game Table. You have chosen a product that should provide years of entertainment. To assist you with customer service and warranty claims, staple your receipt to the inside cover, then keep this manual in a safe place for future reference.











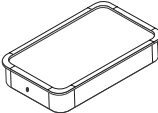
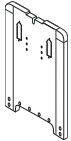
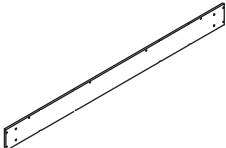
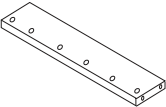
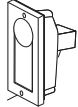

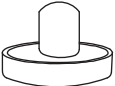
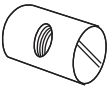





GLD Products



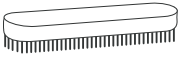
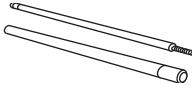

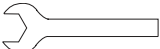



S84 W19093 Enterprise Drive
Muskego, WI 53150 USA
1-800-225-7593
Fax: 1-800-841-6944
Email: gld@gldmfg.com
Web: www.gldproducts.com

This manual may have been updated. For the latest manual visit the GLD Products website.

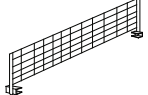
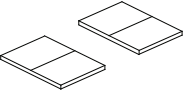
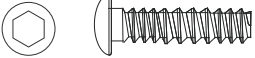
	<p>Place your package near the location where it will be used. Carefully unpack all components and verify you have all the correct pieces.</p> <p>If you notice missing or defective parts, please call us at: 1-800-225-7593</p>
---	--

	<p>Please read and understand all instructions before beginning assembly.</p> <p>This assembly will require 2 adults.</p> <p>This product is not for use by children without adult supervision.</p>
---	--

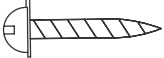
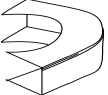
Part No./ Qty	Illustration/ Order Number	Part No./ Qty	Illustration/ Order Number	Part No./ Qty	Illustration/ Order Number
1 Qty. 1	 Table Top Order No. 2-210	2 Qty. 2	 Pedestal Order No. 2-247	3 Qty. 2	 Side Rail Order No. 2-6
4 Qty. 2	 End Rail Order No. 2-8	5 Qty. 4	 Raised Table Lock Order No.2-209	6 Qty. 2	 Puck Catcher Order No. 2-202
7 Qty. 4	 Goalie Order No. 2-18	8 Qty. 18	 1/4 Barrel Nut Order No. 2-12	9 Qty. 4	 Felt Pad Order No. 2-19
10 Qty. 8	 Hex Head Bolt 1/4" x 3" Order No. 2-14	11 Qty. 10	 Hex Head Bolt 1/4" x 2" Order No. 2-13	12 Qty. 18	 1/4" Washer Order No. 2-15
13 Qty. 16	 1/2" Phillips Head Screw Order No.2-31	14 Qty. 6	 3/4" Washer 3 are pre-assembled Order No. 2-16	15 Qty. 4	 3/4" Hex Nut 2 are pre-assembled Order No. 2-17
16 Qty. 4	 Hockey Puck Order No. 2-20	17 Qty. 1 Set	 Billiard Balls Order No. 2-21	18 Qty. 1	 Brush Order No. 2-22
19 Qty. 2	 Cue Stick Order No. 2-23	20 Qty. 2	 Chalk Order No. 2-24	21 Qty. 1	 Open End Wrench Order No. 2-25
22 Qty. 4	 Leg Leveler Order No.2-26	23 Qty. 1	 Triangle Order No. 2-27	24 Qty. 1	 Box Wrench Order No. 1-17

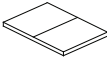
<p>25</p>  <p>Qty. 2</p> <p>Cues Rack Order No. 2-204</p>	<p>26</p>  <p>Qty. 2</p> <p>Accessory Holder Order No. 2-205</p>	<p>27</p>  <p>Qty. 1</p> <p>Table Tennis Net With Posts Order No. 8-10</p>
<p>28</p>  <p>Qty. 2</p> <p>Table Tennis Top (End) Order No. 2-286</p>	<p>29</p>  <p>Qty. 8</p> <p>3/16" x 1" Allen Key Bolt Order No. 2-203</p>	<p>30</p>  <p>Qty. 1</p> <p>Allen Wrench Order No. 2-116</p>
<p>31</p>  <p>Qty. 2</p> <p>Slide Scorer Order No. 2-208</p>	<p>32</p>  <p>Qty. 4</p> <p>F4 x 1" Phillips Countersunk Screw Order No. 2-134</p>	<p>33</p>  <p>Qty. 18</p> <p>W/P4 x 1-14" Screw Pre-assembled Order No. 2-206</p>
<p>34</p>  <p>Qty. 4</p> <p>Wraparound Black Corner Pre-assembled Order No. 2-215</p>	<p>35</p>  <p>Qty. 2</p> <p>Table Tennis Ball Order No. 8-4</p>	<p>36</p>  <p>Qty. 2</p> <p>Table Tennis Bat Order No. 8-5</p>
<p>37</p>  <p>Qty. 1</p> <p>Table Tennis Top (Middle) Order No. 2-287</p>		

IF YOU HAVE A WARRANTY CLAIM, CALL US FIRST

Please see page 16.

GLD Products

Available 8 am to 4:30 pm Central Standard Time

S84 W19093 Enterprise Drive

Muskego, WI 53150 USA

1-800-225-7593

Fax: 1-800-841-6944

Email: gld@gldmfg.com

Web: www.gldproducts.com

For all claims, please have your receipt and item number when you call. The product item number can be found on the front cover.

If you are instructed to return the product for service, you are responsible for shipping the unit at your expense.

PRODUCT REGISTRATION

Important: The product registration form on page 17 and a copy of your receipt must be completed and returned within 10 days of purchase to validate your warranty.

Online registration is also available. Go to <http://gldproducts.com/warranty-information> or click on this link. Follow the online instructions.

Preparing for Assembly

- Be sure to unpack all of the parts included in this package. Check inside any tubes or sleeves. Save all packing material until the product is fully assembled and functional.
- Compare the parts in your package with the Parts Identifier description on page 4. and 5
- After unpacking large products, some disassembly may be required prior to beginning the assembly.

Tools Required

- Allen Wrench (#30)
- Open End Wrench (#21)
- Box Wrench (#24)
- Phillips Screwdriver (not included)
- Flat Blade Screwdriver (not included)
- Level (not included)
- Electric screwdriver may be helpful. **CAUTION:** You must set at LOW TORQUE and use extreme caution because you could overtighten the hardware, strip the screws, or damage the table.

Assembly Tips

Make sure you understand the following before you begin to assemble your game table.

1. READ THIS MANUAL all the way through before beginning assembly.
2. When installing parts that have more than one bolt, start ALL bolts in that part by hand before tightening anything.
3. Some drawings or images in this manual may not look exactly like your product.
4. You may need a second adult to assist with this assembly.

Note: Save all packing materials until the parts have been inspected and the table is assembled.

Unpack the Pieces

- Lay the box on a flat surface (floor). You may want this near your area of assembly.
- Unpack the boxes and part bags. Inspect and count the parts. The Parts Identifier page can be used to record your results.
- If any parts are damaged or missing, contact GLD Customer Service.
- Missing fasteners may be purchased at a hardware store using the descriptions on the Parts Identifier page.

Games

This game table includes the equipment and game pieces for the following games:

Air Hockey Pool Table Tennis

The rules for these games are not discussed in this manual.

STEP 1 - ASSEMBLE THE PEDESTAL

Remove all components from the carton.

NOTE: Parts are packed inside the table top (#1). Remove the pool table surface from the table top (#1) by removing all the screws (#33) that hold it in place. Inside the table top you will find all the parts needed to assemble your table. When all the parts are out of the table top, replace the pool table surface. Reattach the pool table surface by replacing the screws (#33). The assembly parts will include a total of 18 screws (#33). This includes the screws you removed when separating the pool table surface from the table top (#1). Be sure to use all 18 screws (#33) when you reattach the pool table surface to the table top (#1)

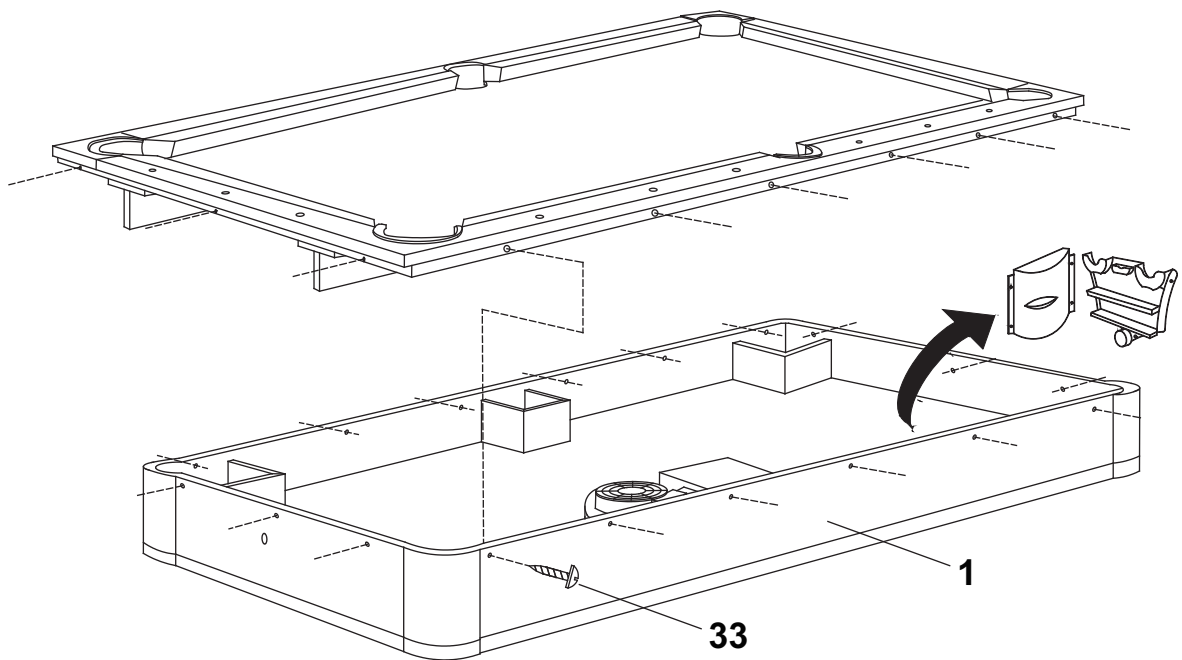

1. Carefully remove the two (#2) pedestals and four levelers (#22) from the package.
2. Insert levelers into pre-drilled holes in the bottom of each leg of the pedestal and secure part way.

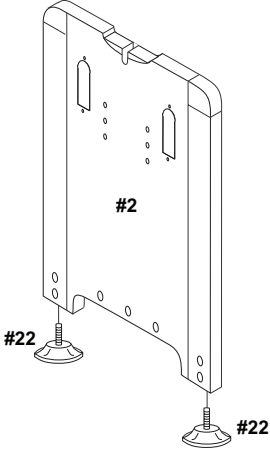

STEP 2 - ATTACH THE TABLE LOCKS

IMPORTANT: The T-nuts are pressed in at the factory. They are on the side of the pedestal that faces the table top (the inside).

1. Attach two table locks (#5) to the outside of each pedestal using bolt (#29).

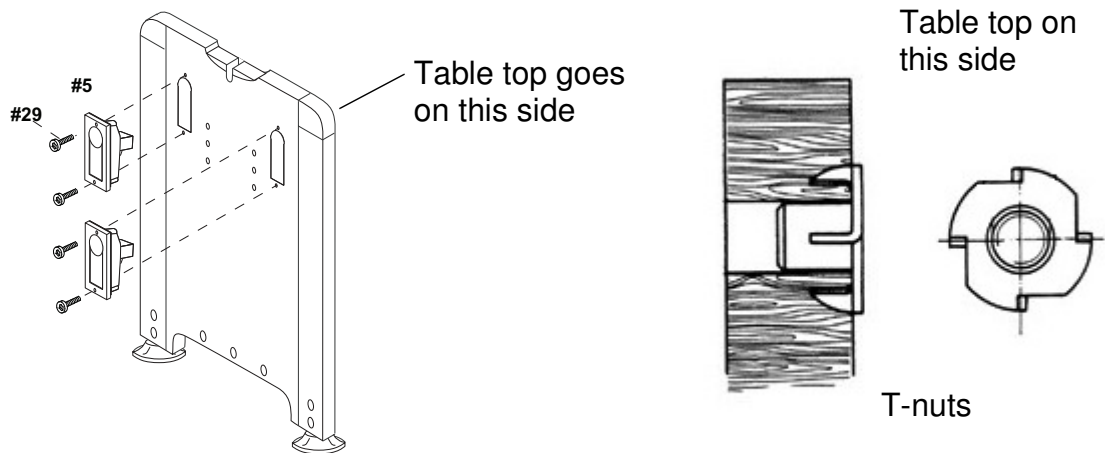

STEP 3 - ASSEMBLE THE BASE

1. With the help of another person, attach the end rails (#4) to the side rails (#3) using 2" hex bolts (#11), washers (#12), and barrel nuts (#8). Hand tighten bolts.

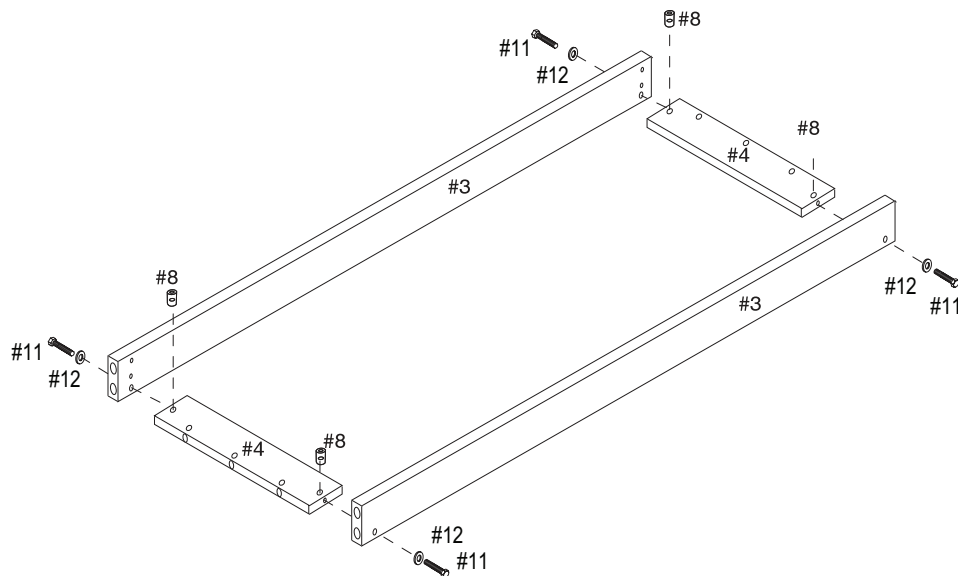

STEP 4 - SECURE THE BASE TO THE PEDESTALS

1. Insert barrel nuts (#8) into the seven holes in the base.
2. Start the four 3" hex head bolts (#10) with 1/4" washers (#12) through the ends of the pedestal and into the side rails. Finger tighten.
3. Start the three 2" hex head bolts (#11) with 1/4" washers (#12) through the center of the pedestal and into the end rails. Finger tighten.
4. Tighten all bolts using the box wrench (#24).

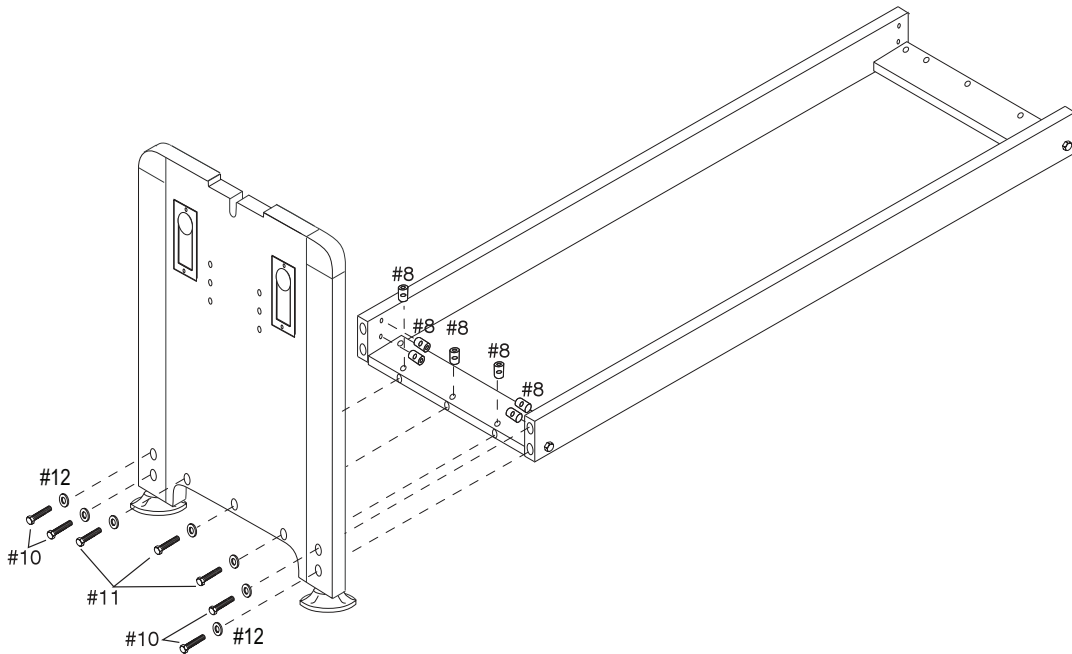

STEP 5 - ATTACH THE TABLE TOP

NOTE: The end of the table top with the power cord has the three 3/4" washers (#14) and two 3/4" hex nuts (#15) pre-assembled on the power cord.

It is possible that the support axle bolts are not pushed out completely. To pull them out, thread a nut onto the end and pull outward with pliers. If the bolt does not pull out freely, tap it with a hammer to break it loose, then pull.

1. Open all four of the table locks.

WARNING: Dropping the table or resting all of the table weight on one or two of closed table locks is likely to break the lock mechanism.

2. Place one 3/4" washer (#14) over the support axle. Thread the 3/4" hex nut (#15) onto the axle followed by another washer (#14).
3. Lift the table top into position over the side supports.
4. Lower the table top so the supporting axles drop into the slots in the pedestals.

NOTE: The two washers and the nut should be placed to the inside of the pedestals.

5. Place another washer (#14) and thread a nut (#15) onto the support axle.
6. Release all of the table locks. Tighten the nuts on the support axle to provide smooth table top rotation.

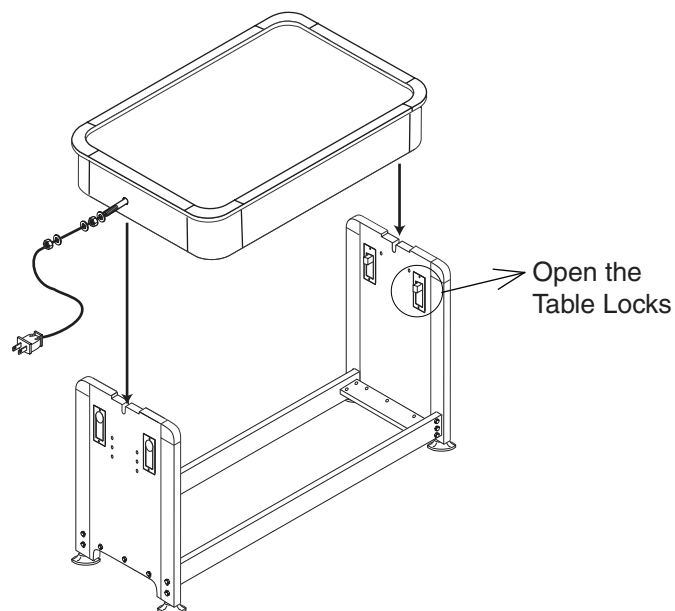
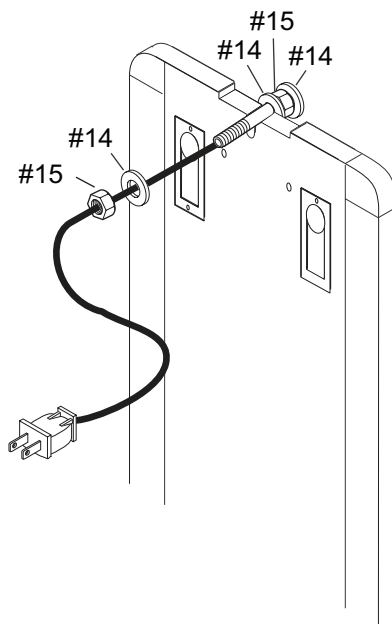

STEP 6 - ATTACH PUCK CATCHERS AND ACCESSORY HOLDER

1. Align the puck catcher (#6) with the pre-drilled holes on each end of the playing table. Secure it to the pedestal with round head screws (#13). Run the power cord through the puck catcher.
2. Align the accessory holder (#26) with the pre-drilled holes on each end of the playing table. Secure it to the pedestal with screws (#13).
3. Attach both slide scorers (#31) to the edges of the playing table using four screws (#32).
4. The table tennis top is made up of three pieces; two ends (#28) and one middle (#37). Push the three pieces together and use the attached velcro strips to secure them.
5. The net (#27) is attached to the middle section (#37).

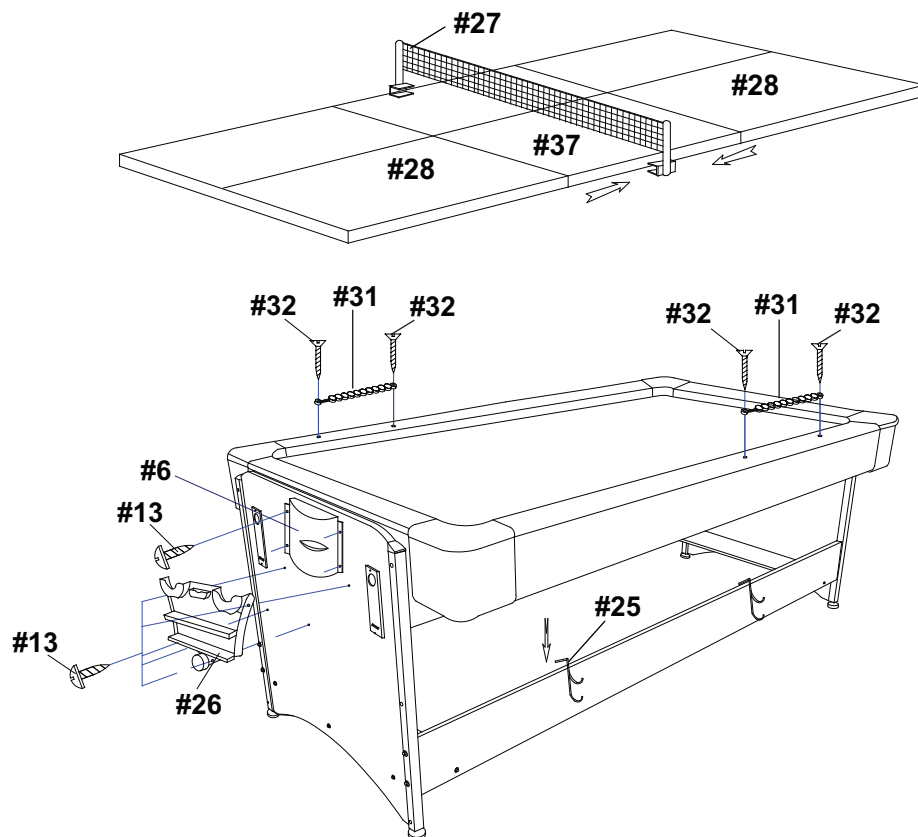

STEP 7 - ADJUST LEVELERS

1. With the help of another person, turn each leg leveler until the table rests level to floor.
2. Check with a carpenters level placed cross-wise and length-wise on the table top.
3. Readjust levelers if necessary.

STEP 8 - ASSEMBLE GOALIES

Remove backing from felt pads (#9) and place on bottom of goalies (#7).

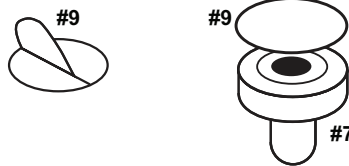

The assembly is complete.

To Rotate the Table:

CAUTION: This should be performed by an adult. The rotating table may pinch body parts.

- Pull out two table locks on one end.
- On the other end, pull out the two table locks.

WARNING: You must open all four of the table locks. Do not rotate the table with any of the table locks closed. The momentum of the rotating table may break the lock.

- Slowly rotate the table.
- Push in the table locks.

To Level the Table:

- Place a carpenters level on the table.
- Screw the leg levelers in or out until table is level.

Troubleshooting:

- If the pool table side is not level, first try to level it by using the leg levelers on each leg. Most of the time the table can be easily leveled using this method.

If the fan does not go on:

- Unplug the fan from electrical outlet.
- Inspect wiring for proper connection.
- Plug in to test.

If the fan works but the table has dead spots:

- Use a small drill bit and clear the holes by hand. DO NOT use electric drill. Manually push the drill bit into the holes to clear.

Clean the surface by spraying a rag (do not spray directly onto the table top) with a furniture polish (like Pledge) and buffing the surface of the table and the puck. This will provide a bit more “float” which may help prevent getting hung up in the “dead” areas.

Care and Use of your Table

- This product is intended for INDOOR use only.
- DO NOT sit, climb, or lean on the table.
- DO NOT drag the table when moving it. This will damage the legs.
- Keep your table covered.
- To clean the hard surfaces spray a cloth with a mild cleaner and wipe.
- Pucks that fly off the table may have chipped edges. Inspect the puck and replace if needed.

90-DAY LIMITED WARRANTY

The Manufacturer warrants to the original retail purchaser that this product is free from defects in material and workmanship under normal use and conditions for a period of ninety (90) days from the date of original purchase. The Manufacturer's liability is limited to the repair or replacement, at its option, of any defective product and shall not include any liability for indirect, incidental or consequential damages of any kind. Should this product become defective due to material or workmanship within the warranty period, contact our Customer Service Department. This warranty is not transferable and does not cover normal wear and tear or damage caused by improper usage, negligence, misuse, abuse, transportation damage, acts of nature, or accident (including failure to follow the instructions in this manual). It does not cover expendable items such as batteries, light bulbs, fuses, accessories, cosmetic parts and other items that wear out due to normal usage, including felt covered areas of the playing surface. This warranty is also void if the product is disassembled and reassembled, damaged, modified from its original state, or used for other than indoor personal residential use (no commercial or rental applications).

This warranty gives you specific legal rights, and you may have other rights which vary from state to state.

IF YOU HAVE A WARRANTY CLAIM, CALL US FIRST (8 - 4:30 CST)

Please have your receipt and item number (found on the front cover) when you call.

GLD Products

S84 W19093 Enterprise Drive

Muskego, WI 53150 USA

1-800-225-7593

Fax: 1-800-841-6944

Email: gld@gldmfg.comWeb: www.gldproducts.com

If you are instructed to return the product for service, you are responsible for shipping the unit at your expense to the above address in packaging that will protect against further damage. All warranty or repair requests require a Return Authorization Number prior to returning the item.

PRODUCT REGISTRATION

Important: The product registration form on page 17 must be completed and returned along with a copy of your receipt within 10 days of purchase to validate your warranty.

Online registration is also available. Go to <http://gldproducts.com/warranty-information> or click on this link. Follow the online instructions.

REGISTER YOUR PRODUCT

Place postage here

Complete this form, include a copy of your receipt, fold, tape (do not staple) and return within 10 days of purchase. This protects your warranty and will help us develop new products!

Cut here.

GLD Products
Warranty Department
S84 W19093 Enterprise Drive
Muskego, WI 53150 USA

Fold here second.



P R O D U C T S

www.gldproducts.com

GAME TABLES	HOME CASINO
GAMES AND ACCESSORIES	BILLIARD CUES
BILLIARD ACCESSORIES	DARTBOARDS
SOFT-TIP DARTS	STEEL-TIP DARTS
FLIGHTS AND SHAFTS	DART CASES AND ACCESSORIES

Fold here first.

Name	Date of Purchase
Address	Phone-Day
City	Phone-Evening
State Zip	Email
Purchase Price:	Item: 64-1046 Game Table
Store Name:	

Remember to attach a copy of your receipt.

This page left intentionally blank.

Mail To: GLD Products
 S84 W19093 Enterprise Drive
 Muskego, WI 53150 USA
 1-800-225-7593 • FAX 800-841-6944
 Email: gld@gldmfg.com
 Web Site: www.gldproducts.com

Pockey 3 in 1 Table

Item 64-1046

Parts Re-Order Form

Name		Date
Address		Phone-Day
City		Phone-Evening
State	Zip	Email

Order No.	Description	Unit Price (each)	Qty.	Total Amount
2-210	Table Top	500.00		
2-247	Pedestal	50.00		
2-6	Side Rail	25.00		
2-8	End Rail	25.00		
2-209	Raised Table Lock	10.00		
2-202	Puck Catcher	10.00		
2-203	Allen Key Bolt 3/16" x 1"	0.25		
2-12	1/4" Barrel Nut	0.25		
2-13	Hex Head Bolt 1/4" x 2"	2.00		
2-14	Hex Head Bolt 1/4" x 3"	2.00		
2-15	1/4" Washer	0.25		
2-16	3/4" Washer	0.20		
2-17	3/4" Hex Nut	0.20		
2-18	Goalie	6.00		
2-19	Felt Pad	1.00		
2-20	Hockey Puck	1.50		
2-21	Billiard Balls	30.00		
2-22	Brush	8.00		
2-23	Cue Stick	12.00		
2-24	Chalk	2.00		
2-25	Open End Wrench	1.00		
2-26	Leg Levelers	10.00		
2-27	Triangle	6.00		
1-17	Box Wrench	1.00		
2-204	Cue Rack	5.00		
2-205	Accessory Holder	10.00		
2-31	1/2" Phillips Head Screw	0.20		
2-286	Table Tennis Top (End) 1 piece	40.00		
2-287	Table Tennis Top (Middle) 1 piece	40.00		
8-5	Table Tennis Bat	6.00		
8-10	Table Tennis Net with Posts	19.00		
8-4	Table Tennis Ball	1.00		
2-116	Allen Key	1.00		
2-206	W/P4 x 1-1/4" Screw	0.20		
2-215	Wraparound Black Corner, Top and Bottom	10.00		
2-208	Slide Scorer	6.00		
2-134	F4 x 1" Phillips Countersunk Screw	0.25		
		Subtotal		
Shipping will be added. If paid by Check or Money Order, call for quote.		S/H		
5.1% Waukesha Wisconsin tax will apply (subject to change).		Tax		
		Total		

Method of Payment

_____ Check or Money Order

_____ Credit Card

_____ Visa _____ MasterCard _____ Discover _____ American Express

Card # _____

Security Code # _____ Billing Address Zip code _____

Signature _____ Exp. Date _____

Shipping Address

Name _____

Address _____ Phone _____

City _____ State _____ Zip _____

GLD[®]

P R O D U C T S

www.gldproducts.com

GAME TABLES

HOME CASINO

GAMES AND ACCESSORIES

BILLIARD CUES

BILLIARD ACCESSORIES

DARTBOARDS

SOFT-TIP DARTS

STEEL-TIP DARTS

FLIGHTS AND SHAFTS

DART CASES AND ACCESSORIES



PROUD MANUFACTURER OF



Yesterday's games for today's families!
by GLD Products



S84 W19093 Enterprise Drive • Muskego, WI 53150 USA
262.679.8730 or 1.800.225.7593 tele
262.679.8738 or 1.800.841.6944 fax
Email: gld@gldmfg.com
www.gldproducts.com