

**SIMPLEHOME™**  
— LIFE BY DESIGN —

WyndenHall™  
HOME DECOR

brooklyn + max™

**TAYLOR / MANFORD / WINSLOW**

---

**WINGBACK CHAIR**

MODEL # AXCCHR-019-DBR

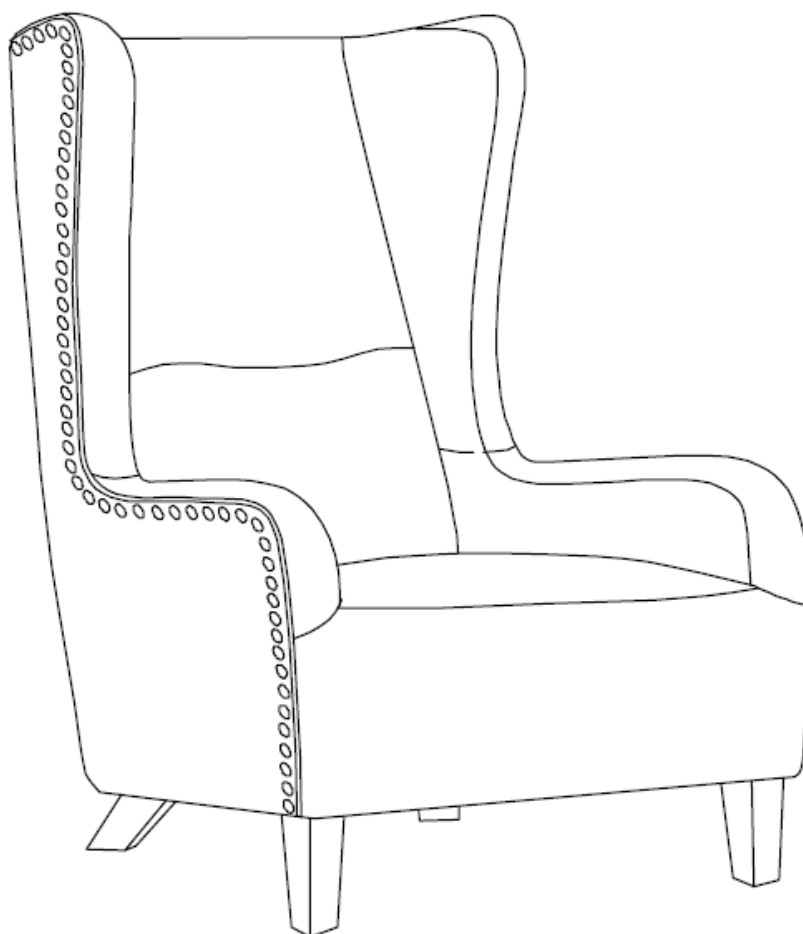



**Questions, problems, assembly help, missing parts?**

No need to return the product, we will gladly help and ship your replacement parts free of charge

Please call Customer Service at 1-866-518-0120 ext. 262

Monday to Friday between 9 am – 4 pm EST

or go to

[www.simpli-home.com/parts request](http://www.simpli-home.com/parts request)

In order to assist you in a timely manner, please have the following information ready:

Model # \_\_\_\_\_ Part Number or Letter \_\_\_\_\_

Purchased at \_\_\_\_\_ Date of Purchase \_\_\_\_\_

**If you wish to return the product, please contact the retailer where the product was purchased.**

**IMPORTANT:** Please read this manual carefully before beginning assembly of this product. Keep this manual for future reference.

## SAFETY INFORMATION

Identify all the parts and hardware. Do not discard of the packaging until you have checked that you have all of the parts and hardware required. Hardware package may have spare parts.

**WARNING:** This item contains small parts which can be swallowed by children and pets. Keep children and pets away during assembly. To avoid danger of suffocation, always keep plastic bags away from children and pets.

We recommend that you assemble this unit on a carpeted floor to avoid scratches. We do not recommend the use of power tools for assembly as this could damage the unit. Only use manual tools.

**Requires 2 people for ease of assembly.**

## CARE and MAINTENANCE

Wipe regularly with clean water and a damp, clean, soft white cloth.

General cleaning can be done as needed with a mild detergent and water solution. Always rinse with clean water and dry.

For heavy soiling, dampen a soft white cloth or soft bristle brush. Use care as scrubbing can damage the surface.

More difficult stains can be treated, but this should be occasional, not daily, cleaning. ANY cleaning solution used must be removed with clean water and a clean white cloth. Cleaning residue left on the material can cause it to dry out and crack, or affect the color.

DO NOT use any cleaners with corrosive ingredients (lye, acids or ammonia).

# PRE-ASSEMBLY INFORMATION

## PARTS DESCRIPTION

A

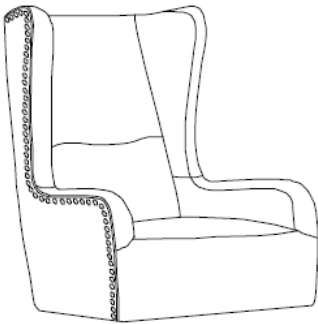

CHAIR  
QTY 1

B

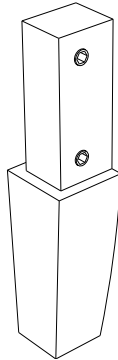

FRONT LEG  
QTY 2

C

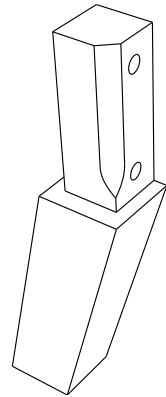

BACK LEG  
QTY 2

**NEED HELP?** For help with assembly or if you are missing a part,  
Please call customer service at 1-866-518-0120 ext. 262 (9 am to 4 pm EST)

# PRE-ASSEMBLY INFORMATION

## HARDWARE DESCRIPTION

1

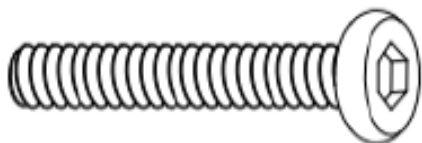

BOLT  
M8\*60mm  
QTY 8

2



FLAT WASHER  
M8  
QTY 8

3

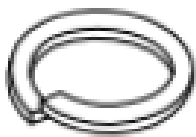

LOCK WASHER  
M8  
QTY 8

4

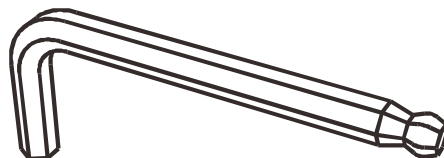

ALLEN KEY  
M8  
QTY 1

**NEED HELP?** For help with assembly or if you are missing a part,  
Please call customer service at 1-866-518-0120 ext. 262 (9 am to 4 pm EST)

# ASSEMBLY

## STEP 1

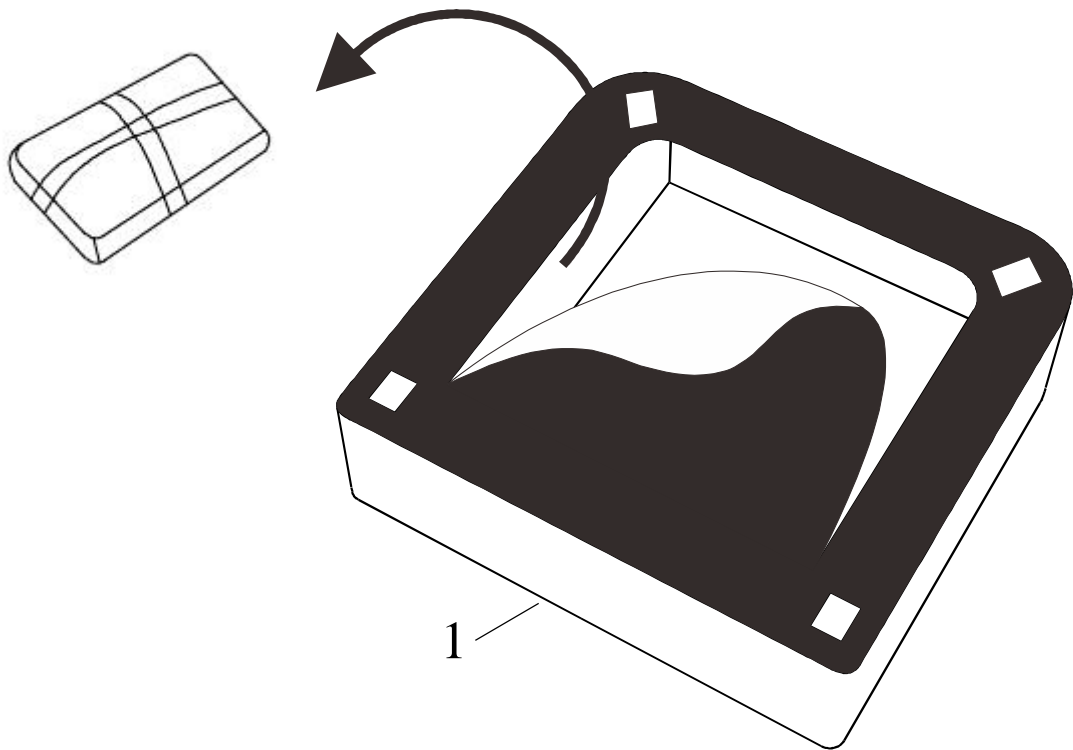

Place the Chair (A) on its back on a flat smooth surface.  
Remove the Legs (B and C) and hardware package from inside  
the fabric of the bottom of the Chair (A).

# ASSEMBLY

## STEP 2

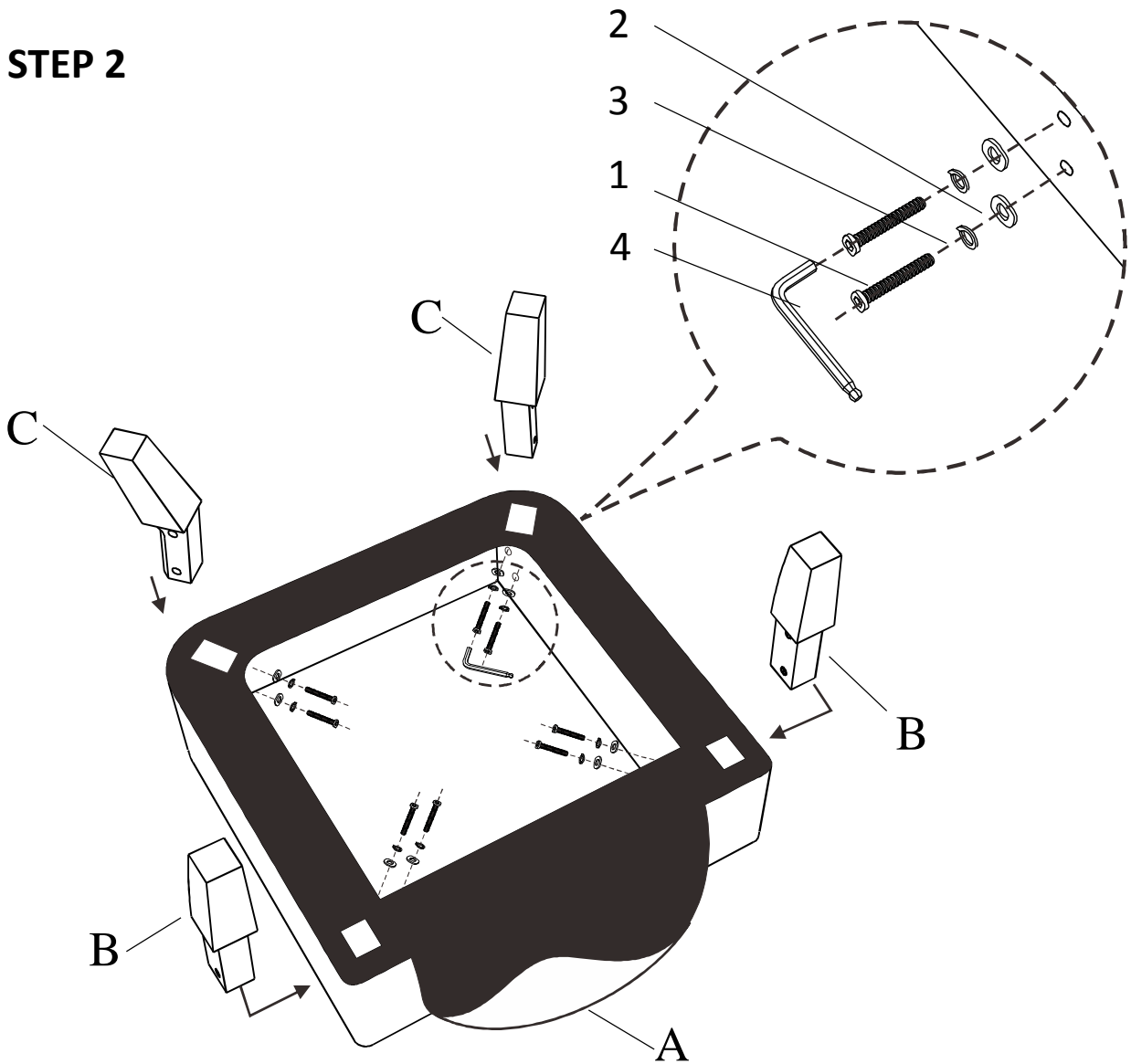

Attach the Front Legs (B) and Back Legs (C) with Bolts (1), Lock Washers (3) and Flat Washers (2).  
Use Allen Key (4) to tighten.

# ASSEMBLY

## STEP 3

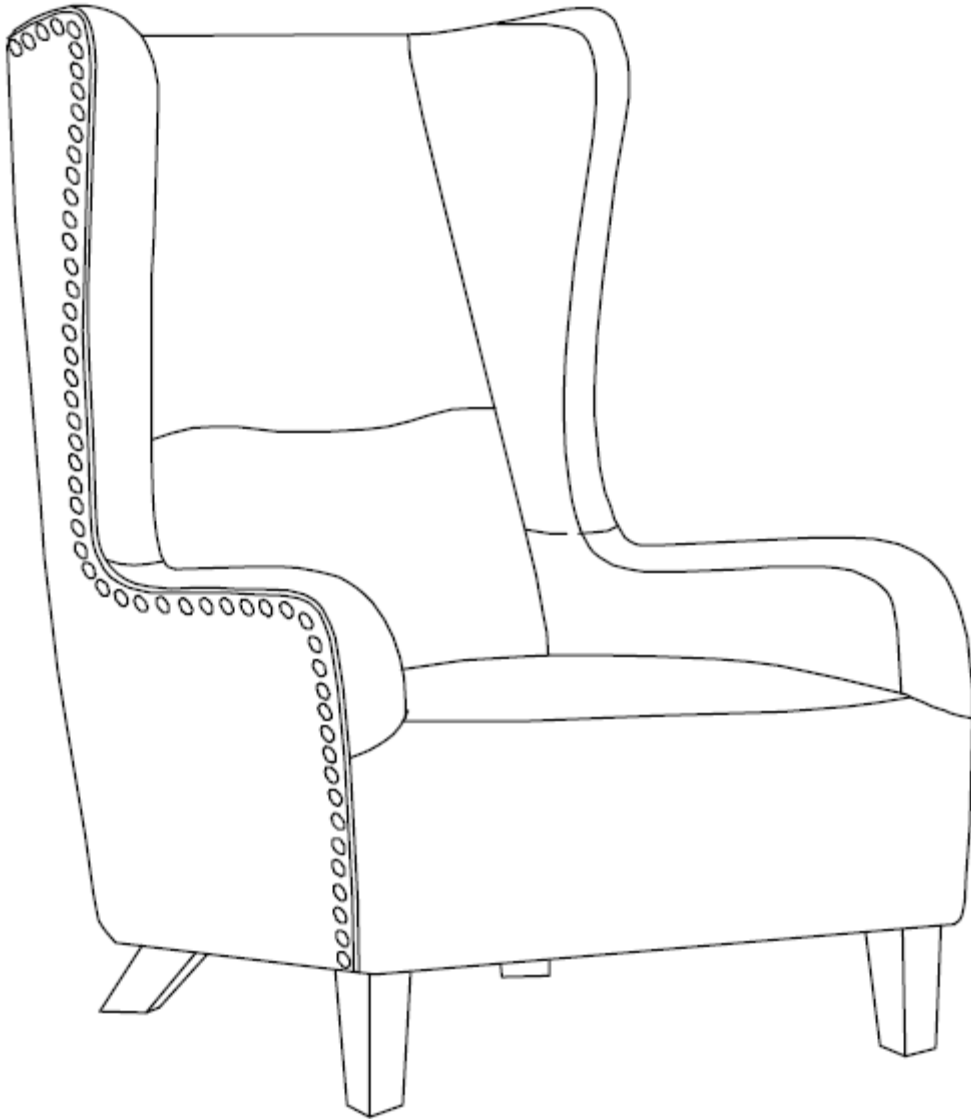

Turn the Chair right side up.





## WARRANTY

Thank you for purchasing a **Simpli Home – Wyndenhall – Brooklyn + Max** product. These products have been made to demanding, high-quality standards and are guaranteed for domestic use against manufacturing faults for a period of 12 months from the date of purchase. This warranty does not affect your statutory rights.

In case of any malfunction of your product (failure, missing parts, etc.) please contact us at our toll free service line at 1-866-518-0120 ext. 262 from 9 am to 4 pm, Monday to Friday, Eastern Standard Time or by email at [customerservice@simpli-home.com](mailto:customerservice@simpli-home.com).

We reserve the right to repair or replace the defective product, at its discretion.

This product is guaranteed for 12 months if used for normal purposes. Any warranty is invalid if the product has been overloaded or subject to neglect, improper use or an attempted repair by other than an authorized agent. Heavy-duty or daily professional/commercial usage are not guaranteed.

Due to continuous product improvement, we reserve the right to change the product specifications without prior notice.