

ATTENTION: INSTALLING PERSONNEL KEY POINTS FOR A SUCCESSFUL INSTALLATION

Read This First

- Pay close attention to the items in this sheet to complete a successful installation.
- Read the "I-Series Plus Condensing Boiler Installation and Operation Manual" (referred to as "Manual" on this sheet) before you proceed. Use the "Post-Installation Checklist" (Section 11 in Manual) after completing installation.
- You must flush the CH plumbing system prior to installation (Section 14 in Manual).
- This boiler is configured for Natural Gas. To convert to Propane, use the Liquid Propane Field Conversion Kit supplied with the boiler.
- Pay close attention when unpacking the boiler carton box as it contains numerous parts, including the wall mounting bracket, pressure relief valve, Liquid Propane Field Conversion Kit, and more. Confirm all included parts are located inside boiler carton box.

PC Board

PC Board Buttons (Section 12 in Manual)

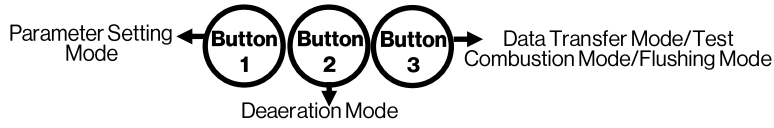

PC Board Electrical Connections (Section 9 in Manual)

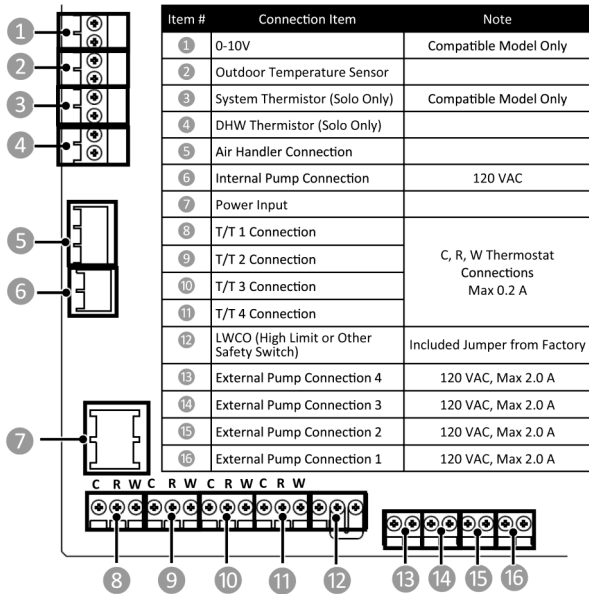

This boiler requires 120 VAC, 60 Hz power from a properly grounded circuit. Use caution when connecting power to the boiler.

COMBI

Heat-Only on Reverse Side

I-Series Plus Condensing Boiler

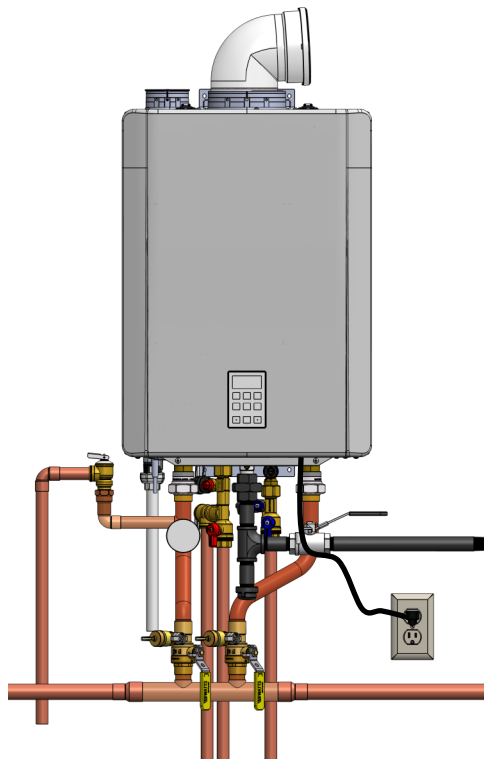

Venting Options

Direct Vent

(See Section 5 in Manual)

Non-Direct Vent

Concentric Pipe



Twin Pipe



Be sure to complete installation of the exhaust pipe before turning on power to the boiler.

Room Air

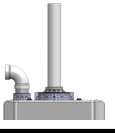

Parameter Settings

To adjust the parameters:

1. Press and hold the left PC Board button (Button 1) for five seconds. **00-A** appears on the display.
2. Press the **▲** (Up) or **▼** (Down) arrows to select a parameter setting number. Then, press the **Select** button.
3. Press the **▲** (Up) or **▼** (Down) arrows to change the selection for the setting number (such as **11-R** or **11-b**).
4. Press the **Select** button.
5. To exit parameter settings and enter normal operation mode, press the left PC Board button (Button 1).

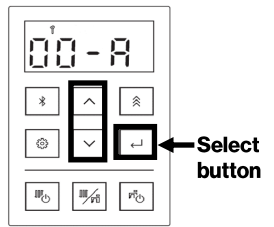

A Few Settings Are Shown Below. See Section 12 in Manual for Complete List

Para #	Setting Description	Selection						
		R	b	C	d	E	F	H
01	Outdoor Reset Curve: This parameter shows up only when selecting Outdoor Temperature Sensor "In Use" as selecting parameter number 00.	Curve 1 Standard baseboard, high-efficiency air handler, or panel radiators	Curve 2 Staple up radiant	Curve 3 High temperature air handler or undersized baseboard	Curve 4 Cast Iron Baseboard	Curve 5 Radiators	Curve 6 High Mass Radiant	Curve 7 Custom curve based on customer inputs
02	Gas Type: Selects the gas type when conducting gas conversion.	Natural Gas	Liquid Propane					
03	Vent Material Used: Selects the venting material used. The boiler is set from the factory to be installed in a PVC venting system. If CPVC, PP, or other approved venting is used, this setting may be adjusted. See Section 5 in Manual for more information.	PVC	Material other than PVC: CPVC/PP/Other					

Piping

(Section 3 in Manual)

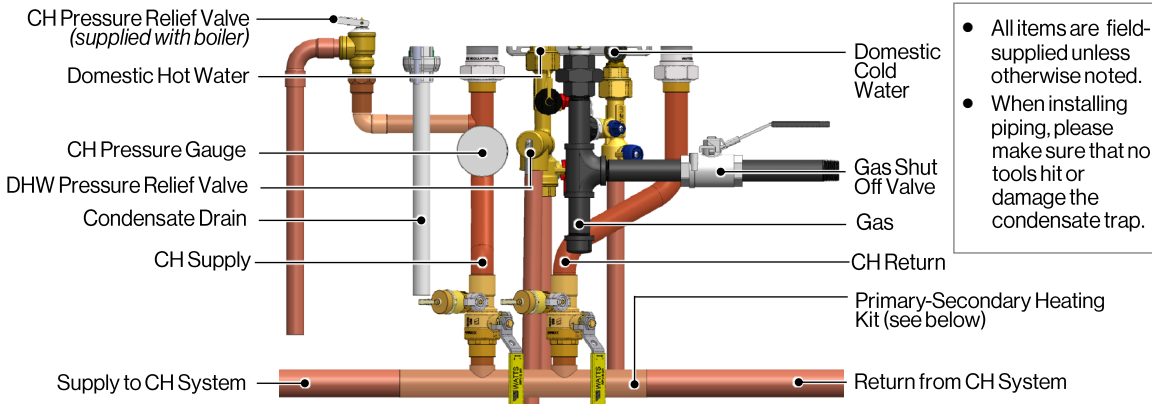

- All items are field-supplied unless otherwise noted.
- When installing piping, please make sure that no tools hit or damage the condensate trap.

Initial Settings

(Section 9.4 in Manual)

This boiler is set up for natural gas and PVC indoor installations as default. When power is connected for the first time, you must confirm the boiler's initial settings or change them properly.

WARNING

If proper settings are not selected before you use the boiler, it will cause a hazardous situation which results in personal injury or property damage.

You can confirm/change initial settings of the boiler by choosing one of the two options below:

Option 1 (RECOMMENDED OPTION): Confirm/change settings from a smart device using Bluetooth Low Energy (BLE).

Option 2: Confirm/change settings from the boiler controller.

1. Supply power to the boiler for the first time.
2. The controller displays "SE" and the **Maintenance Mode** icon on the controller is blinking.

Maintenance Mode icon



3. Follow the remaining instructions in section "9.4 Initial Settings" in the manual, which explains how to select the gas type (natural gas or propane) and

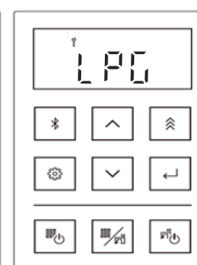

(Depending on the models)

Hydraulic Separation

(Section 8 in Manual)

Rinnai requires hydraulic separation between the boiler and central heating system (except as noted below). Hydraulic separation and primary/secondary piping allow two or more circulators in a hydronic system to operate independently, without interfering with flow in connecting piping circuits. Closely spaced tees and low loss headers are common examples of hydraulic separators and are used to separate the boiler loop from the central heating loop. For more information, refer to sections "14.8 CH Pressure Drop and Flow Curve" and "14.9 DHW Pressure Drop and Flow Curve."

Primary-Secondary Heating Kit

Optional Accessory Offered by Rinnai. Must be Purchased Separately.

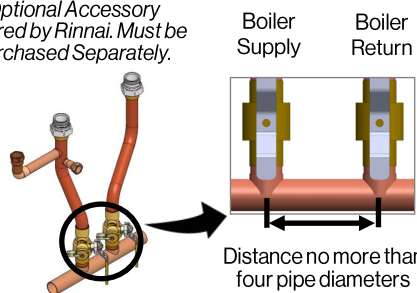

Low Loss Header



Distance no more than four pipe diameters

¹ When an alternate air handler is used with a Rinnai I-Series Plus Boiler with no additional heat emitters or an indirect tank:

- It is not required to utilize primary/secondary piping.
- A minimum of 3 GPM (11 L/min) flow is needed for proper operation of the system.

Refer to the Rinnai Hydronic Air Handler Installation and Operation Manual for installation and performance details.

Outdoor Reset Control and Curves

(Section 12 in Manual)

Outdoor Temperature Sensor

- Mount on a North facing wall of the house below an eave to avoid direct sunlight.
- Mount away from any vent, duct, or other device that may create an artificial heat source.
- Wire the sensor back to the outdoor temperature sensor terminal on the boiler.

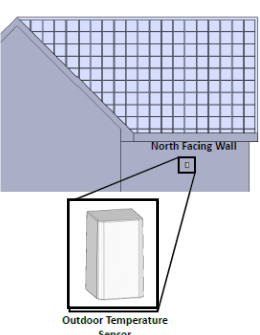

The boiler has seven outdoor reset heating curves, which are different target temperature lines dependent on the outdoor temperature. The selected curve should be based off of the type of heat emitter and the target temperature desired.

Curves 1-6

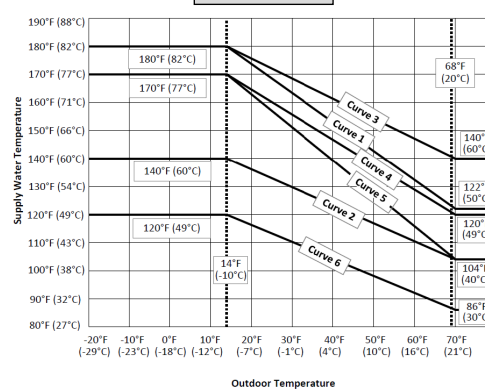

Curve 7

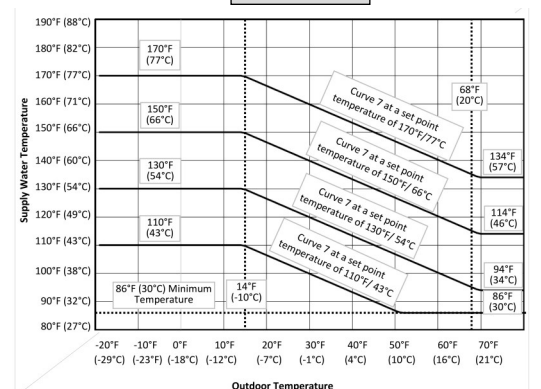

230 00012 66882 4



H167-0779 X 01(00)

800000197(01)
3/2024

Rinnai®

ATTENTION: INSTALLING PERSONNEL KEY POINTS FOR A SUCCESSFUL INSTALLATION

Read This First

- Pay close attention to the items in this sheet to complete a successful installation.
- Read the "I-Series Plus Condensing Boiler Installation and Operation Manual" (referred to as "Manual" on this sheet) before you proceed. Use the "Post-Installation Checklist" (Section 11 in Manual) after completing installation.
- You must flush the CH plumbing system prior to installation (Section 14 in Manual).
- This boiler is configured for Natural Gas. To convert to Propane, use the Liquid Propane Field Conversion Kit supplied with the boiler.
- Pay close attention when unpacking the boiler carton box as it contains numerous parts, including the wall mounting bracket, pressure relief valve, Liquid Propane Field Conversion Kit, and more. Confirm all included parts are located inside boiler carton box.

PC Board

PC Board Buttons (Section 12 in Manual)

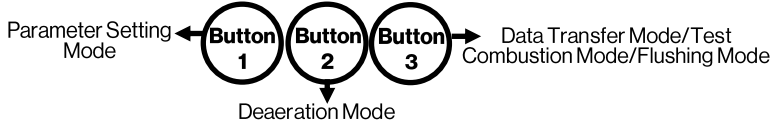

PC Board Electrical Connections (Section 9 in Manual)

Item #	Connection Item	Note
1	0-10V	Compatible Model Only
2	Outdoor Temperature Sensor	
3	System Thermistor (Solo Only)	Compatible Model Only
4	DHW Thermistor (Solo Only)	
5	Air Handler Connection	
6	External Boiler Pump Connection	120 VAC
7	Power Input	
8	T/T 1 Connection	C, R, W Thermostat Connections Max 0.2 A
9	T/T 2 Connection	
10	T/T 3 Connection	
11	T/T 4 Connection	
12	LWCO (High Limit or Other Safety Switch)	Included Jumper from Factory
13	External Pump Connection 4	120 VAC, Max 2.0 A
14	External Pump Connection 3	120 VAC, Max 2.0 A
15	External Pump Connection 2	120 VAC, Max 2.0 A
16	External Pump Connection 1	120 VAC, Max 2.0 A

This boiler requires 120 VAC, 60 Hz power from a properly grounded circuit. Use caution when connecting power to the boiler.

HEAT-ONLY

Combi on Reverse Side

I-Series Plus Condensing Boiler

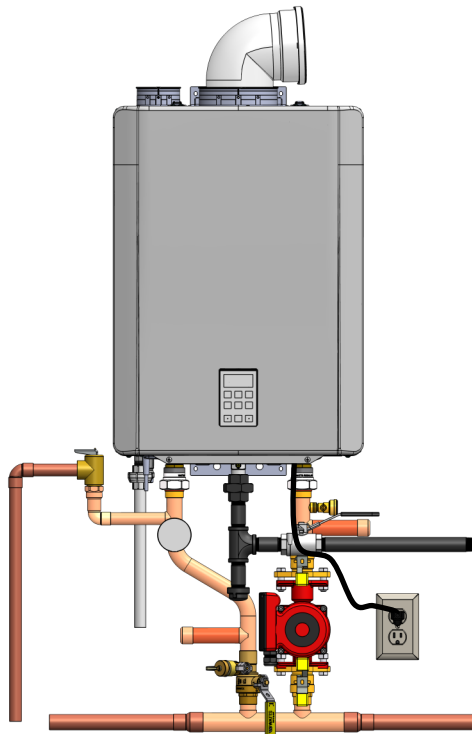

Venting Options

Direct Vent

(See Section 5 in Manual)

Non-Direct Vent

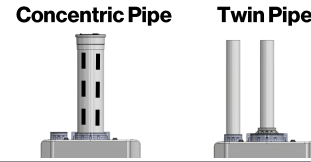

Be sure to complete installation of the exhaust pipe before turning on power to the boiler.

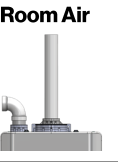

Parameter Settings

To adjust the parameters:

1. Press and hold the left PC Board button (Button 1) for five seconds. **00-R** appears on the display.
2. Press the **▲** (Up) or **▼** (Down) arrows to select a parameter setting number. Then, press the **Select** button.
3. Press the **▲** (Up) or **▼** (Down) arrows to change the selection for the setting number (such as **11-R** or **11-b**).
4. Press the **Select** button.
5. To exit parameter settings and enter normal operation mode, press the left PC Board button (Button 1).

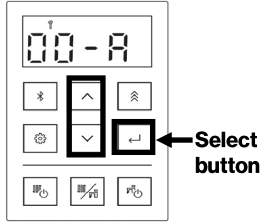

A Few Settings Are Shown Below. See Section 12 in Manual for Complete List

Para #	Setting Description	Selection							
		R	b	C	d	E	F	H	
01	Outdoor Reset Curve: This parameter shows up only when selecting Outdoor Temperature Sensor "In Use" as selecting parameter number 01.	Curve 1 Standard baseboard, high-efficiency air handler, or panel radiators	Curve 2 Staple up radiant	Curve 3 High temperature air handler or undersized baseboard	Curve 4 Cast Iron Baseboard	Curve 5 Radiators	Curve 6 High Mass Radiant	Curve 7 Custom curve based on customer inputs	
02	Gas Type: Selects the gas type when conducting gas conversion.	Natural Gas	Liquid Propane						
03	Vent Material Used: Selects the venting material used. The boiler is set from the factory to be installed in a PVC venting system. If CPVC, PP, or other approved venting is used, this setting may be adjusted. See Section 5 in Manual for more information.	PVC	Material other than PVC: CPVC/PP/Other						

Piping

(Section 3 in Manual)

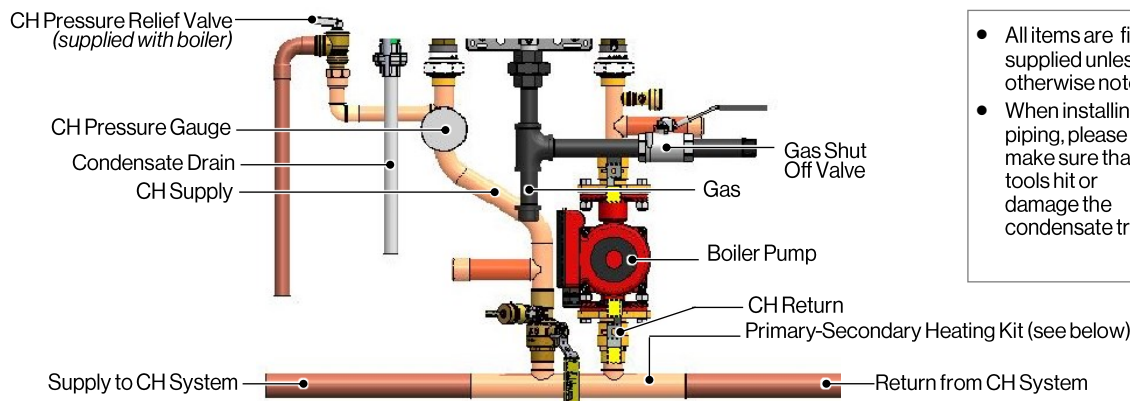

- All items are field-supplied unless otherwise noted.
- When installing piping, please make sure that no tools hit or damage the condensate trap.

Initial Settings

(Section 9.4 in Manual)

This boiler is set up for natural gas and PVC indoor installations as default. When power is connected for the first time, you must confirm the boiler's initial settings or change them properly.

WARNING

If proper settings are not selected before you use the boiler, it will cause a hazardous situation which results in personal injury or property damage.

You can confirm/change initial settings of the boiler by choosing one of the two options below:

Option 1 (RECOMMENDED OPTION): Confirm/change settings from a smart device using Bluetooth Low Energy (BLE).

Option 2: Confirm/change settings from the boiler controller.

1. Supply power to the boiler for the first time.
2. The controller displays "SEt" and the **Maintenance Mode** icon on the controller is blinking.



3. Follow the remaining instructions in section "9.4 Initial Settings" in the manual, which explains how to select the gas type (natural gas or propane) and venting (PVC or PP) (depending on the models).

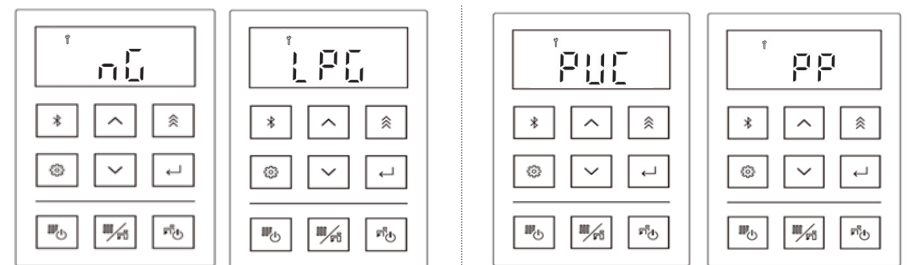

(Depending on the models)

Hydraulic Separation

(Section 7 in Manual)

Rinnai requires hydraulic separation between the boiler and central heating system (except as noted below). The I-Series Plus Heat-Only Boiler does not include a boiler pump. An external boiler pump must be installed and sized to the flow rate and pressure drop through the boiler and hydraulic separator. Hydraulic separation and primary/secondary piping allow two or more circulators in a hydronic system to operate independently, without interfering with flow in connecting piping circuits. Closely spaced tees and low loss headers are common examples of hydraulic separators and can be used to separate the boiler loop from the central heating loop. For more information, refer to section "14.7 CH Pressure Drop and Flow Curve."

Primary-Secondary Heating Kit

Optional Accessory Offered by Rinnai. Must be Purchased Separately.

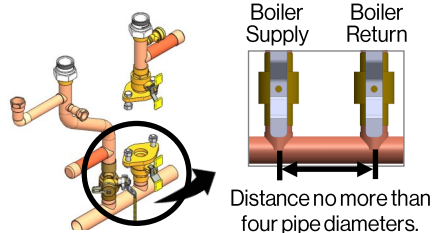

- It is not required to utilize primary/secondary piping.
- A minimum of 3 GPM (11L/min) flow is needed for proper operation of the system.

Refer to the Rinnai Hydronic Air Handler Installation and Operation Manual for installation and performance details.

Low Loss Header



Outdoor Reset Control and Curves

(Section 12 in Manual)

Outdoor Temperature Sensor

- Mount on a North facing wall of the house below an eave to avoid direct sunlight.
- Mount away from any vent, duct, or other device that may create an artificial heat source.
- Wire the sensor back to the outdoor temperature sensor terminal on the boiler.

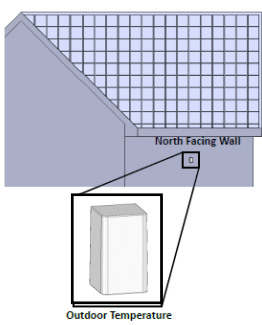

The boiler has seven outdoor reset heating curves, which are different target temperature lines dependent on the outdoor temperature. The selected curve should be based off of the type of heat emitter and the target temperature desired.

