



January 30, 2025

**To:** Whom it may concern,  
**From:** Building Drops, Inc.  
**On behalf of:** Glass Warehouse LLC / FutureGlass  
1319 Rocky Point Drive, Suite 200  
Oceanside, CA 92056  
**Report:** PER 9361  
**Subject:** Fabrikasi Posted Glass Railing System



**Scope:**

The purpose of this report is to evaluate the performance of the Fabrikasi Posted Glass Railing System manufactured by Glass Warehouse LLC / FutureGlass. The conditions in this report meet all the applicable requirements of the current International Building Code. Glass thicknesses and properties were extracted from ASTM E1300. Aluminum members and connections were designed according to ADM Design Guides. ICC Acceptance Criteria AC439 and ASTM E2358 were used for determining applicable design criteria for railing systems. A summary of standards can be found on the following pages.

Only rectangular glass is covered within this report, different glass shapes do not apply to this analysis. Gaskets may be modified according to different glass thicknesses as long as thickness is specified in this analysis.

The posted glass railing system uses Aluminum 6063-T5 posts and top rails to support the glass lights specified herein. The posted glass system has been designed for the following loading conditions:

- 200 lb concentrated load at the top of glass or at the top rail
- 50 lbs linear load applied at the top of glass or at the top rail
- Allowable wind load as shown on the tables within this report

This report provides glass thicknesses the posts have been designed to support. Other glass thicknesses may be used but are outside of the scope of this report.

**Instructions for Use**

1. Select post spacing and height based on jobsite wind loads using tables 2, 4, and 6.
2. Select anchor type with allowable wind load higher than step 1 from tables 7 through 10.
3. Select Glass Type with allowable wind load higher than step 1 from tables 12 through 18.

Project Description: Glass Warehouse LLC / FutureGlass – Fabrikasi Posted Glass Railing System	Date: January 30, 2025	Customer: Glass Warehouse LLC / FutureGlass	
		Project #: EEV-24-0628	
	Engineer: SH	PER: 9361	Page #: Page 1 of 39



YOU ENVISION IT – WE ENGINEER IT

1900 NE Miami Ct., Ste. 2-15  
Miami, FL 33132  
TEL: 954.399-8478 | FAX: 954.744.4738  
WEB: [www.buildingdrops.com](http://www.buildingdrops.com)

**Fabrikasi Posted Glass Railing System**

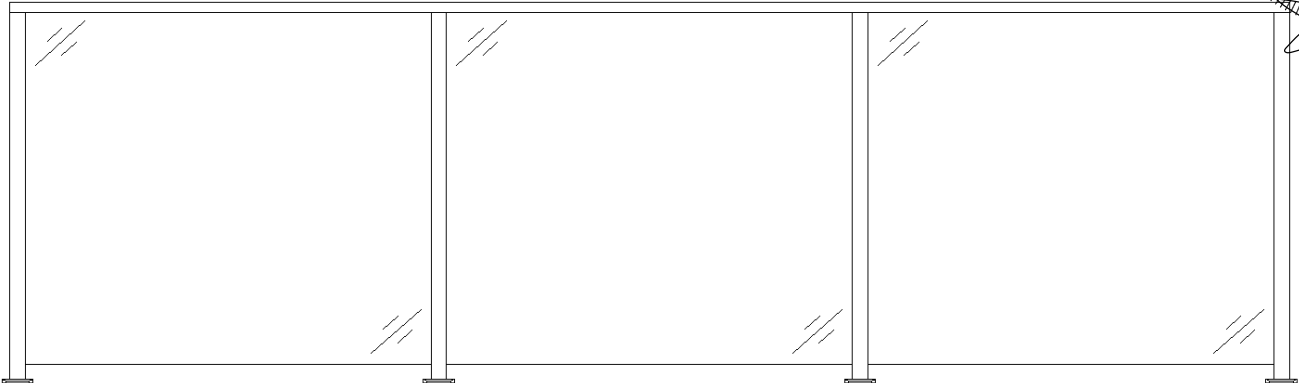
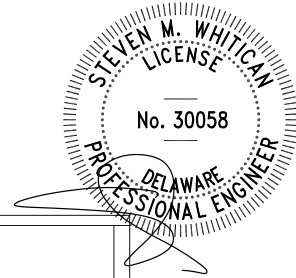

**Standards/Referenced Publications**

ASTM E1300	IBC 1607.8.1	ICC AC439
ASTM E2358	AISC Design Guides	ASTM C1048-97b
CPSC 16 CFR 1201	ANSI Z97.1	AAMA CW-12-84, Structural Properties for glass
ADM 2018	IBC 2407.1.1	NDS 2018
ASTM E6.2.1.1	SEI/ASCE 8-02	

**Limits of Use:**

1. This product has been evaluated and is in compliance with the 2015, 2018, and 2021 editions of the International Building Code.
2. Product installation shall be as listed herein. Site conditions that deviate from those specified shall require further engineering analysis by a licensed engineer or registered architect.
3. When used in areas requiring wind borne debris protection this product complies with chapter 16 of the 2015, 2018, and 2021 editions of the International Building Code and does require an impact resistant covering in areas requiring impact resistance.

Project Description: Glass Warehouse LLC / FutureGlass – Fabrikasi Posted Glass Railing System	Date: January 30, 2025	Customer: Glass Warehouse LLC / FutureGlass	
		Project #: EEV-24-0628	
	Engineer: SH	PER: 9361	Page #: Page 2 of 39



YOU ENVISION IT – WE ENGINEER IT

1900 NE Miami Ct., Ste. 2-15  
Miami, FL 33132  
TEL: 954.399-8478 | FAX: 954.744.4738  
WEB: [www.buildingdrops.com](http://www.buildingdrops.com)

**Conclusion:**

In my professional opinion, the Fabrikasi Posted Glass Railing System manufactured by Glass Warehouse LLC / FutureGlass is adequate for use under the limitations provided within this report.

I trust that this will satisfy your needs, however, feel free to call if you have any questions.

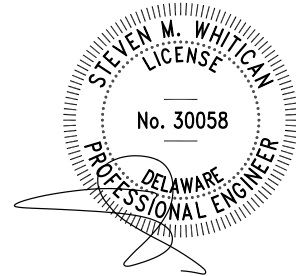

*Certification of Independence: Please note that I do not have nor will I acquire a financial interest in any company manufacturing or distributing the product(s) for which this report is being issued. Also, I do not have nor will I acquire a financial interest in any other entity involved in the approval process of the listed product(s).*

Project Description: Glass Warehouse LLC / FutureGlass – Fabrikasi Posted Glass Railing System	Date: January 30, 2025	Customer: Glass Warehouse LLC / FutureGlass	
		Project #: EEV-24-0628	
	Engineer: SH	PER: 9361	Page #: Page 3 of 39



**Analysis and Findings:**

**Posts Allowable Heights and Wind Loads:**

The stainless-steel post was analyzed for the maximum allowable heights at various post spacings due to the following design loads:

- 200 lb Concentrated Load at the top of the post
- 50 lb/ft Linear Load along the handrail or along the top of the glass
- Allowable Wind Load due to Post Spacing and Height



**Intermediate Post Analysis:**

**Table 1: Maximum Allowable Height of Post**

Max. Allowable Height (in.)							
Post Spacing (in.)							
36	42	48	54	60	66	72	78
78.11	78.11	78.11	69.43	62.49	56.81	52.07	48.07

**Table 2: Maximum Allowable Wind Load of Post**

ALLOWABLE POST WIND LOAD (PSF)								
POST HEIGHT (IN.)	POST SPACING (IN.)							
	36	42	48	54	60	66	72	78
36	87.66	75.14	65.75	58.44	52.60	47.82	43.83	40.46
42	64.41	55.21	48.31	42.94	38.64	35.13	32.20	29.73
48	49.31	42.27	36.98	32.87	29.59	26.90	24.66	22.76
54	38.96	33.40	29.22	25.97	23.38	21.25	-	-
60	31.56	27.05	23.67	21.04	18.94	-	-	-

\*Note: Cells in table which have a “-” are not qualified under this report due to the maximum height being exceeded from the values shown in table 1.

Project Description: Glass Warehouse LLC / FutureGlass – Fabrikasi Posted Glass Railing System	Date: January 30, 2025	Customer: Glass Warehouse LLC / FutureGlass	
	Engineer: SH	Project #: EEV-24-0628	
		PER: 9361	Page #: Page 4 of 39

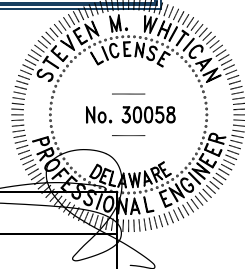

**End Post Analysis:**

**Table 3: Maximum Allowable Height of Post**

Max. Allowable Height (in.)							
Trib. Post Spacing (in.)							
36	42	48	54	60	66	72	78
74.34	74.34	74.34	74.34	74.34	74.34	74.34	74.34

**Table 4: Maximum Allowable Wind Load of Post**

ALLOWABLE POST WIND LOAD (PSF)								
POST HEIGHT (IN.)	POST SPACING (IN.)							
	36	42	48	54	60	66	72	78
36	166.87	143.03	125.15	111.25	100.12	91.02	83.43	77.02
42	122.60	105.08	91.95	81.73	73.56	66.87	61.30	56.58
48	93.86	80.45	70.40	62.58	56.32	51.20	46.93	43.32
54	74.16	63.57	55.62	49.44	44.50	40.45	37.08	34.23
60	60.07	51.49	45.05	40.05	36.04	32.77	30.04	27.73

**90° Corner Post Analysis:**

**Table 5: Maximum Allowable Height of Post**

Max. Allowable Height (in.)							
Trib. Post Spacing (in.)							
36	42	48	54	60	66	72	78
59.47	59.47	59.47	59.47	59.47	59.47	59.47	59.47

**Table 6: Maximum Allowable Wind Load of Post**

ALLOWABLE POST WIND LOAD (PSF)								
POST HEIGHT (IN.)	POST SPACING (IN.)							
	36	42	48	54	60	66	72	78
36	133.49	114.42	100.12	89.00	80.10	72.82	66.75	61.61
42	98.08	84.07	73.56	65.39	58.85	53.50	49.04	45.27
48	75.09	64.36	56.32	50.06	45.05	40.96	37.55	34.66
54	59.33	50.86	44.50	39.55	35.60	32.36	29.67	27.38
60	-	-	-	-	-	-	-	-

Project Description: Glass Warehouse LLC / FutureGlass – Fabrikasi Posted Glass Railing System	Date: January 30, 2025	Customer: Glass Warehouse LLC / FutureGlass	
	Engineer: SH	Project #: EEV-24-0628	
	PER: 9361	Page #: Page 5 of 39	



YOU ENVISION IT – WE ENGINEER IT

1900 NE Miami Ct., Ste. 2-15  
 Miami, FL 33132  
 TEL: 954.399-8478 | FAX: 954.744.4738  
 WEB: [www.buildingdrops.com](http://www.buildingdrops.com)

**Post Installation Analysis:**

**Anchor Summary Table**

Anchor Schedule						
Option	Anchor Type	Brand	Substrate Capacity	Anchor Diameter (in.)	Embedment (in.)	Edge Distance (in.)
A	Wood	5/16" Lag Screw	0.55 S.G.	0.3125	1.50	0.75
B		3/8" Lag Screw	0.55 S.G.	0.375	1.50	0.75
C		1/2" Lag Screw	0.55 S.G.	0.5	1.50	0.75
D	Steel	5/16" Self-Tapping Screw	45000 psi	0.3125	3 Threads	0.50
E		3/8" Self-Tapping Screw	45000 psi	0.375	3 Threads	0.50
F		1/2" Self-Tapping Screw	45000 psi	0.5	3 Threads	0.50
G	Concrete	1/4" Dewalt Screw-Bolt+	3000 psi	0.25	2.50	3.00
H		3/8" Dewalt Screw-Bolt+	3000 psi	0.375	2.50	3.00
I		1/2" Dewalt Screw-Bolt+	3000 psi	0.5	2.50	3.00

**Table 7: Anchor Type G**

ALLOWABLE ANCHOR WIND LOAD (PSF)								
POST HEIGHT (IN.)	POST SPACING (IN.)							
	36	42	48	54	60	66	72	78
36	43.59	37.36	32.69	29.06	26.15	23.78	21.80	20.12
42	32.03	27.45	24.02	21.35	19.22	17.47	16.01	14.78
48	24.52	21.02	18.39	16.35	14.71	13.37	12.26	11.32
54	19.37	16.61	14.53	12.92	11.62	10.57	9.69	8.94
60	15.69	13.45	11.77	10.46	9.42	8.56	7.85	7.24



Project Description: Glass Warehouse LLC / FutureGlass – Fabrikasi Posted Glass Railing System	Date: January 30, 2025	Customer: Glass Warehouse LLC / FutureGlass	
	Engineer: SH	Project #: EEV-24-0628	
	PER: 9361	Page #: Page 6 of 39	



**Table 8: Anchor Types A & D**

ALLOWABLE ANCHOR WIND LOAD (PSF)								
POST HEIGHT (IN.)	POST SPACING (IN.)							
	36	42	48	54	60	66	72	78
36	48.44	41.52	36.33	32.30	29.07	26.42	24.22	22.36
42	35.59	30.51	26.69	23.73	21.36	19.41	17.80	16.43
48	27.25	23.36	20.44	18.17	16.35	14.86	13.63	12.58
54	21.53	18.46	16.15	14.35	12.92	11.74	10.77	9.94
60	17.44	14.95	13.08	11.63	10.46	9.51	8.72	8.05

**Table 9: Anchor Types B, E, & H**

ALLOWABLE ANCHOR WIND LOAD (PSF)								
POST HEIGHT (IN.)	POST SPACING (IN.)							
	36	42	48	54	60	66	72	78
36	56.70	48.60	42.53	37.80	34.02	30.93	28.35	26.17
42	41.66	35.71	31.24	27.77	24.99	22.72	20.83	19.23
48	31.89	27.34	23.92	21.26	19.14	17.40	15.95	14.72
54	25.20	21.60	18.90	16.80	15.12	13.75	12.60	11.63
60	20.41	17.50	15.31	13.61	12.25	11.13	10.21	9.42

**Table 10: Anchor Types C, F, & I**

ALLOWABLE ANCHOR WIND LOAD (PSF)								
POST HEIGHT (IN.)	POST SPACING (IN.)							
	36	42	48	54	60	66	72	78
36	70.44	60.38	52.83	46.96	42.26	38.42	35.22	32.51
42	51.75	44.36	38.81	34.50	31.05	28.23	25.88	23.88
48	39.62	33.96	29.72	26.41	23.77	21.61	19.81	18.29
54	31.31	26.83	23.48	20.87	18.78	17.08	15.65	14.45
60	25.36	21.74	19.02	16.91	15.21	13.83	12.68	11.70

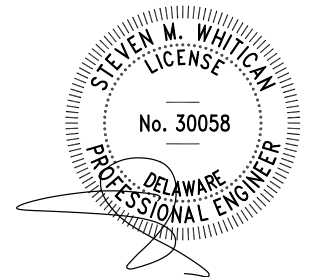

Project Description: Glass Warehouse LLC / FutureGlass – Fabrikasi Posted Glass Railing System	Date: January 30, 2025	Customer: Glass Warehouse LLC / FutureGlass	
	Engineer: SH	Project #: EEV-24-0628	
	PER: 9361	Page #: Page 7 of 39	



**Glass Strength**

**Table 11: Glass properties extracted from ASTM E1300**

Glass Properties				
Glass types	Modulus of rupture, psi	All. Bending Stress, psi	All. Compressive Stress, psi	All. Glass Stress per ASTM E1300, psi
Tempered	24000	6000	6000	9600
Heat Strengthened	12000	3000	3000	5300
Annealed	6000	1500	1500	2900

**Table 12: 5/16" Monolithic Tempered Glass Allowable Wind Loads**

Allowable Wind Load Table (PSF) - 5/16" Tempered Glass								
Glass Height (in.)	Post Spacing (in.)							
	36.0	42.0	48.0	54.0	60.0	66.0	72.0	78.0
36.0	121.26	89.09	68.21	-	-	-	-	-
42.0	121.26	89.09	68.21	53.90	-	-	-	-
48.0	121.26	89.09	68.21	53.90	43.66	-	-	-
54.0	121.26	89.09	68.21	53.90	43.66	36.08	-	-
60.0	121.26	89.09	68.21	53.90	43.66	36.08	30.32	-

**Table 13: 3/8" Monolithic Tempered Glass Allowable Wind Loads**

Allowable Wind Load Table (PSF) - 3/8" Tempered Glass								
Glass Height (in.)	Post Spacing (in.)							
	36.0	42.0	48.0	54.0	60.0	66.0	72.0	78.0
36.0	179.24	131.68	100.82	79.66	64.52	53.33	44.81	-
42.0	179.24	131.68	100.82	79.66	64.52	53.33	44.81	38.18
48.0	179.24	131.68	100.82	79.66	64.52	53.33	44.81	38.18
54.0	179.24	131.68	100.82	79.66	64.52	53.33	44.81	38.18
60.0	179.24	131.68	100.82	79.66	64.52	53.33	44.81	38.18

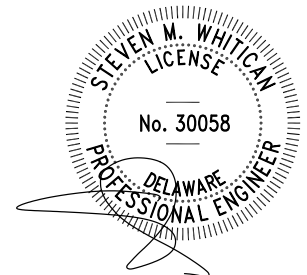

Project Description: Glass Warehouse LLC / FutureGlass – Fabrikasi Posted Glass Railing System	Date: January 30, 2025	Customer: Glass Warehouse LLC / FutureGlass	
	Engineer: SH	Project #: EEV-24-0628	
	PER: 9361	Page #: Page 8 of 39	



**Table 14: 1/2" Monolithic Tempered Glass Allowable Wind Loads**

Allowable Wind Load Table (PSF) - 1/2" Tempered Glass								
Glass Height (in.)	Post Spacing (in.)							
	36.0	42.0	48.0	54.0	60.0	66.0	72.0	78.0
36.0	312.89	229.88	176.00	139.06	112.64	93.09	78.22	66.65
42.0	312.89	229.88	176.00	139.06	112.64	93.09	78.22	66.65
48.0	312.89	229.88	176.00	139.06	112.64	93.09	78.22	66.65
54.0	312.89	229.88	176.00	139.06	112.64	93.09	78.22	66.65
60.0	312.89	229.88	176.00	139.06	112.64	93.09	78.22	66.65

**Table 15: 7/16" Laminated Glass: 3/16" Tempered Glass – 0.060" PVB – 3/16" Tempered Glass**

Allowable Wind Load Table (PSF)								
Glass Height (in.)	Post Spacing (in.)							
	36.0	42.0	48.0	54.0	60.0	66.0	72.0	78.0
36.0	136.76	108.18	88.40	73.92	-	-	-	-
42.0	136.76	108.18	88.40	73.92	62.87	54.18	-	-
48.0	136.76	108.18	88.40	73.92	62.87	54.18	47.19	41.46
54.0	136.76	108.18	88.40	73.92	62.87	54.18	47.19	41.46
60.0	136.76	108.18	88.40	73.92	62.87	54.18	47.19	41.46

**Table 16: 7/16" Laminated Glass: 3/16" Tempered Glass – 0.060" SentryGlas – 3/16" Tempered Glass**

Allowable Wind Load Table (PSF)								
Glass Height (in.)	Post Spacing (in.)							
	36.0	42.0	48.0	54.0	60.0	66.0	72.0	78.0
36.0	234.71	175.24	135.62	107.97	87.93	72.97	61.51	52.54
42.0	234.71	175.24	135.62	107.97	87.93	72.97	61.51	52.54
48.0	234.71	175.24	135.62	107.97	87.93	72.97	61.51	52.54
54.0	234.71	175.24	135.62	107.97	87.93	72.97	61.51	52.54
60.0	234.71	175.24	135.62	107.97	87.93	72.97	61.51	52.54

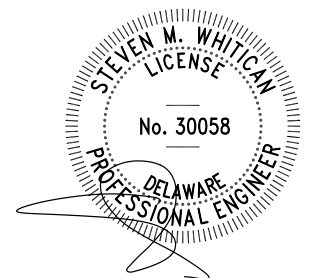

Project Description: Glass Warehouse LLC / FutureGlass – Fabrikasi Posted Glass Railing System	Date: January 30, 2025	Customer: Glass Warehouse LLC / FutureGlass	
	Engineer: SH	Project #: EEV-24-0628	
		PER: 9361	Page #: Page 9 of 39

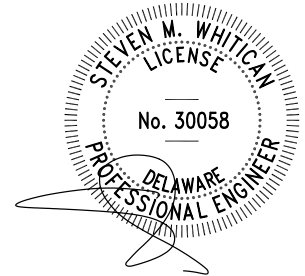

**Table 17: 9/16" Laminated Glass: 1/4" Tempered Glass – 0.060" PVB – 1/4" Tempered Glass**

Allowable Wind Load Table (PSF)								
Glass Height (in.)	Post Spacing (in.)							
	36.0	42.0	48.0	54.0	60.0	66.0	72.0	78.0
36.0	188.09	147.78	120.28	100.39	85.34	73.58	64.16	-
42.0	188.09	147.78	120.28	100.39	85.34	73.58	64.16	56.47
48.0	188.09	147.78	120.28	100.39	85.34	73.58	64.16	56.47
54.0	188.09	147.78	120.28	100.39	85.34	73.58	64.16	56.47
60.0	188.09	147.78	120.28	100.39	85.34	73.58	64.16	56.47

**Table 18: 9/16" Laminated Glass: 1/4" Tempered Glass – 0.060" SentryGlas – 1/4" Tempered Glass**

Allowable Wind Load Table (PSF)								
Glass Height (in.)	Post Spacing (in.)							
	36.0	42.0	48.0	54.0	60.0	66.0	72.0	78.0
36.0	326.39	244.36	189.49	151.07	123.16	102.29	86.27	73.73
42.0	326.39	244.36	189.49	151.07	123.16	102.29	86.27	73.73
48.0	326.39	244.36	189.49	151.07	123.16	102.29	86.27	73.73
54.0	326.39	244.36	189.49	151.07	123.16	102.29	86.27	73.73
60.0	326.39	244.36	189.49	151.07	123.16	102.29	86.27	73.73



Project Description: Glass Warehouse LLC / FutureGlass – Fabrikasi Posted Glass Railing System	Date: January 30, 2025	Customer: Glass Warehouse LLC / FutureGlass	
	Engineer: SH	Project #: EEV-24-0628	
	PER: 9361	Page #: Page 10 of 39	

**Cap Rail Allowable Span Calculations**

Guard applications require a top rail or handrail. The rail shall have adequate strength to support the live load of 200 lb concentrated or 50 plf distributed load assuming the failure of one glass light at the location of the loading. No US building codes or adopted standards define the limit state of the guard cap rail for this condition. IBC 2407.1.2 states “shall be otherwise supported to remain in place should one baluster fail.” There is no additional explanation in the IBC as to how this is to be determined. ICC Acceptance Criteria 439 was adopted to provide a methodology for determining if a glass balustrade guard meets the requirements of IBC 2407. ICC AC 439 requires the rail to be capable of supporting a 334# load (SF = 1.67 for 200# load) with no more than 12” deflection, yielding or other damage is permitted since the loss of a glass light will necessitate guard repairs. For light failure only the horizontal load case applies for laminated glass.

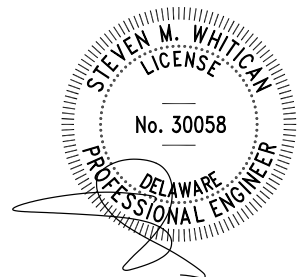
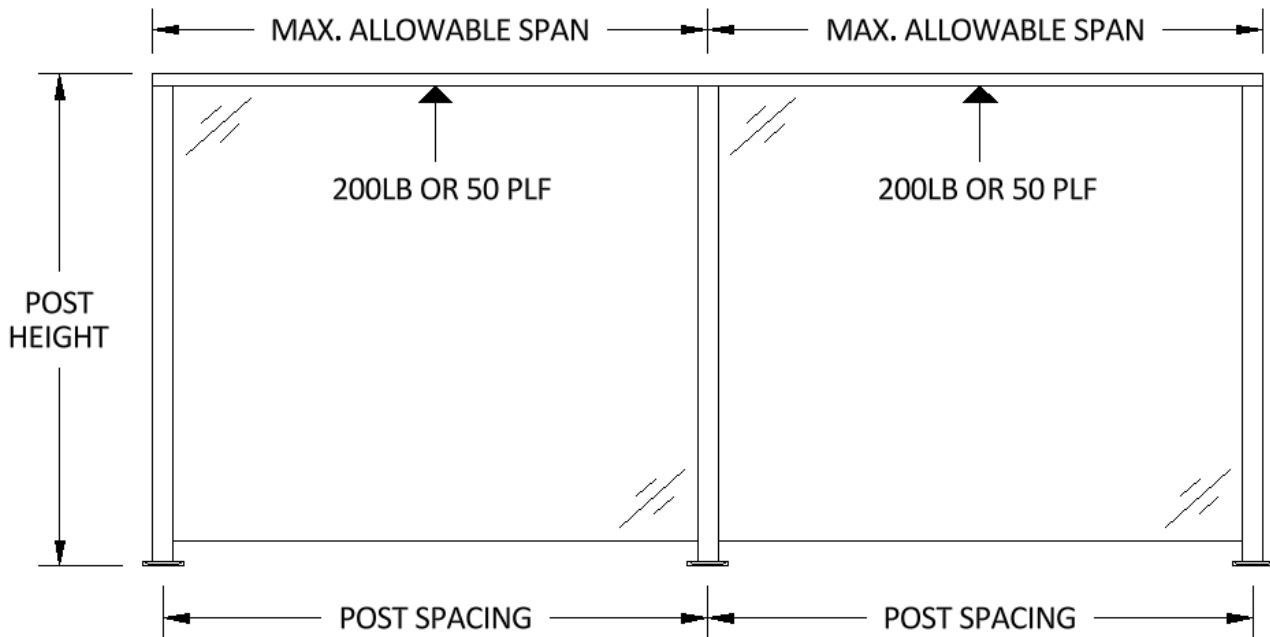

Project Description: Glass Warehouse LLC / FutureGlass – Fabrikasi Posted Glass Railing System	Date: January 30, 2025	Customer: Glass Warehouse LLC / FutureGlass	
	Engineer: SH	Project #: EEV-24-0628	
	PER: 9361	Page #: Page 11 of 39	

**GSW005/006 Top Rail Allowable Span**

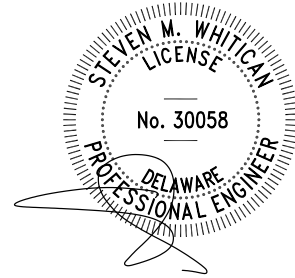

Top Rail = GSW 005/006

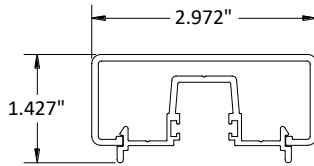

- Area = 0.8653 in<sup>2</sup>
- Perim. = 22.1741 in
- Ixx = 0.1840 in<sup>4</sup>
- Iyy = 0.8134 in<sup>4</sup>
- rx = 0.4611 in
- ry = 0.9695 in
- Cxx = 1.4862 in
- Cyy = 0.8367 in
- Sxx = 0.2199 in<sup>3</sup>
- Syy = 0.5473 in<sup>3</sup>
- t = 0.087 in
- w = 0.8349 in

Material = 6063-T5

- Fy = 21 ksi
- Fu = 27 ksi

$$M_n = 1.25 S_e F_y$$

- M<sub>n Vertical Load</sub> = 5.7727 k-in
- M<sub>n Horizontal Load</sub> = 14.3667 k-in

**Simply Supported Rail**

$$M_w = wL^2/10$$

- L<sub>uniform Vert.</sub> = 117.70 in
- L<sub>uniform Horiz.</sub> = 185.69 in

$$M_c = PL/5$$

- L<sub>concentrated vert.</sub> = 144.32 in
- L<sub>concentrated horiz.</sub> = 359.17 in

**Allowable Rail Span = 117 in = 9.75 ft**

Project Description: Glass Warehouse LLC / FutureGlass – Fabrikasi Posted Glass Railing System	Date: January 30, 2025	Customer: Glass Warehouse LLC / FutureGlass	
		Project #: EEV-24-0628	
	Engineer: SH	PER: 9361	Page #: Page 12 of 39



YOU ENVISION IT – WE ENGINEER IT

1900 NE Miami Ct., Ste. 2-15  
Miami, FL 33132  
TEL: 954.399-8478 | FAX: 954.744.4738  
WEB: [www.buildingdrops.com](http://www.buildingdrops.com)



# APPENDIX

Project Description: Glass Warehouse LLC / FutureGlass – Fabrikasi Posted Glass Railing System	Date: January 30, 2025	Customer: Glass Warehouse LLC / FutureGlass	
		Project #: EEV-24-0628	
	Engineer: SH	PER: 9361	Page #: Page 13 of 39



**Aluminum Post**

Post Name = Intermediate Post  
 Post Material = 6063-T5  
 Modulus of Elasticity = 10100000 lbs/in<sup>2</sup>  
 $F_y = 21000$  lbs/in<sup>2</sup>  
 $I_{xx} = 0.5762$  in<sup>4</sup>  
 $I_{yy} = 0.3996$  in<sup>4</sup>  
 $S_{xx} = 0.5854$  in<sup>3</sup>  
 $S_{yy} = 0.4060$  in<sup>3</sup>  
 $Z_{xx} = 0.7439$  in<sup>3</sup>  
 $Z_{yy} = 0.5640$  in<sup>3</sup>  
 Allowable Post Moment,  $M_a = 15621.9$  lbs-in

Max. Height Due to 200lb Concentrated Load at Top of Post

$M_{200} = 200 * H$   
 Max. Post Height = 78.11 in

Max. Heights Due to 50 lb/ft Load at Various Post Spacings

$M_{50plf} = 50/12 * H * S$

Max. Height (in.)							
Post Spacing (in.)							
36	42	48	54	60	66	72	78
104.15	89.27	78.11	69.43	62.49	56.81	52.07	48.07

Max. Allowable Height

Max. Allowable Height (in.)							
Post Spacing (in.)							
36	42	48	54	60	66	72	78
78.11	78.11	78.11	69.43	62.49	56.81	52.07	48.07

Allowable Wind Load Due to Allowable Moment of Post

$W = (144 * M_a) / (0.55 * S * H^2)$

Allowable Wind Load (PSF)								
Post Height (in)	Post Spacing (in.)							
	36	42	48	54	60	66	72	78
36	87.66	75.14	65.75	58.44	52.60	47.82	43.83	40.46
42	64.41	55.21	48.31	42.94	38.64	35.13	32.20	29.73
48	49.31	42.27	36.98	32.87	29.59	26.90	24.66	22.76
54	38.96	33.40	29.22	25.97	23.38	21.25	-	-
60	31.56	27.05	23.67	21.04	18.94	-	-	-

Project Description: Glass Warehouse LLC / FutureGlass – Fabrikasi Posted Glass Railing System	Date: January 30, 2025	Customer: Glass Warehouse LLC / FutureGlass	
	Engineer: SH	Project #: EEV-24-0628	
		PER: 9361	Page #: Page 14 of 39



YOU ENVISION IT – WE ENGINEER IT

1900 NE Miami Ct., Ste. 2-15  
 Miami, FL 33132  
 TEL: 954.399-8478 | FAX: 954.744.4738  
 WEB: [www.buildingdrops.com](http://www.buildingdrops.com)

**Aluminum Post**

PostName = End Post  
 Post Material = 6063-T5  
 Modulus of Elasticity = 10100000 lbs/in<sup>2</sup>  
 F<sub>y</sub> = 21000 lbs/in<sup>2</sup>  
 I<sub>xx</sub> = 0.5587 in<sup>4</sup>  
 I<sub>yy</sub> = 0.4328 in<sup>4</sup>  
 S<sub>xx</sub> = 0.5676 in<sup>3</sup>  
 S<sub>yy</sub> = 0.4306 in<sup>3</sup>  
 Z<sub>xx</sub> = 0.7080 in<sup>3</sup>  
 Z<sub>yy</sub> = 0.5838 in<sup>3</sup>  
 Allowable Post Moment, M<sub>s</sub> = 14868.0 lbs-in

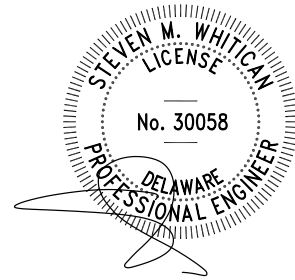

Max. Height Due to 200lb Concentrated Load at Top of Post

M<sub>200</sub> = 200 \* H  
 Max. Post Height = 74.34 in

Max. Heights Due to 50 lb/ft Load at Various Post Spacings

M<sub>50aft</sub> = 50/12 \* H \* S

Max. Height (in.)							
Trib. Post Spacing (in.)							
18	21	24	27	30	33	36	39
198.24	169.92	148.68	132.16	118.94	108.13	99.12	91.50

Max. Allowable Height

Max. Allowable Height (in.)							
Trib. Post Spacing (in.)							
18	21	24	27	30	33	36	39
74.34	74.34	74.34	74.34	74.34	74.34	74.34	74.34

Allowable Wind Load Due to Allowable Moment of Post

W = (144 \* M<sub>s</sub>) / (0.55 \* S \* H<sup>2</sup>)

Allowable Wind Load (PSF)								
Post Height (in)	Trib. Post Spacing (in.)							
	18	21	24	27	30	33	36	39
36	166.87	143.03	125.15	111.25	100.12	91.02	83.43	77.02
42	122.60	105.08	91.95	81.73	73.56	66.87	61.30	56.58
48	93.86	80.45	70.40	62.58	56.32	51.20	46.93	43.32
54	74.16	63.57	55.62	49.44	44.50	40.45	37.08	34.23
60	60.07	51.49	45.05	40.05	36.04	32.77	30.04	27.73

Project Description: Glass Warehouse LLC / FutureGlass – Fabrikasi Posted Glass Railing System	Date: January 30, 2025	Customer: Glass Warehouse LLC / FutureGlass	
	Engineer: SH	Project #: EEV-24-0628	
		PER: 9361	Page #: Page 15 of 39



YOU ENVISION IT – WE ENGINEER IT

1900 NE Miami Ct., Ste. 2-15  
 Miami, FL 33132  
 TEL: 954.399-8478 | FAX: 954.744.4738  
 WEB: [www.buildingdrops.com](http://www.buildingdrops.com)

**Aluminum Post**

Post Name = 90° Post  
 Post Material = 6063-T5  
 Modulus of Elasticity = 10100000 lbs/in<sup>2</sup>  
 F<sub>y</sub> = 21000 lbs/in<sup>2</sup>  
 I<sub>xx</sub> = 0.4294 in<sup>4</sup>  
 I<sub>yy</sub> = 0.4294 in<sup>4</sup>  
 S<sub>xx</sub> = 0.4283 in<sup>3</sup>  
 S<sub>yy</sub> = 0.4283 in<sup>3</sup>  
 Z<sub>xx</sub> = 0.5664 in<sup>3</sup>  
 Z<sub>yy</sub> = 0.5664 in<sup>3</sup>  
 Allowable Post Moment, M<sub>a</sub> = 11894.4 lbs-in



**Max. Height Due to 200lb Concentrated Load at Top of Post**

M<sub>200</sub> = 200 \* H  
 Max. Post Height = 59.47 in

**Max. Heights Due to 50 lb/ft Load at Various Post Spacings**

M<sub>50pft</sub> = 50/12 \* H \* S

Max. Height (in.)							
Trib. Post Spacing (in.)							
18	21	24	27	30	33	36	39
158.59	135.94	118.94	105.73	95.16	86.50	79.30	73.20

**Max. Allowable Height**

Max. Allowable Height (in.)							
Trib. Post Spacing (in.)							
18	21	24	27	30	33	36	39
59.47	59.47	59.47	59.47	59.47	59.47	59.47	59.47

**Allowable Wind Load Due to Allowable Moment of Post**

W = (144 \* M<sub>a</sub>) / (0.55 \* S \* H<sup>2</sup>)

Post Height (in)	Allowable Wind Load (PSF)							
	Trib. Post Spacing (in.)							
	18	21	24	27	30	33	36	39
36	133.49	114.42	100.12	89.00	80.10	72.82	66.75	61.61
42	98.08	84.07	73.56	65.39	58.85	53.50	49.04	45.27
48	75.09	64.36	56.32	50.06	45.05	40.96	37.55	34.66
54	59.33	50.86	44.50	39.55	35.60	32.36	29.67	27.38
60	-	-	-	-	-	-	-	-

Project Description: Glass Warehouse LLC / FutureGlass – Fabrikasi Posted Glass Railing System	Date: January 30, 2025	Customer: Glass Warehouse LLC / FutureGlass	
	Engineer: SH	Project #: EEV-24-0628	
		PER: 9361	Page #: Page 16 of 39

**5/16" Lag Screw into Mixed Maple-Southern Pine w/ 0 in. of Gap Space.**

**Base Plate Installation**

Calculations herein are performed in accordance with the National Design Specification for Wood Construction - 2018, Chapter 12.3 and Technical Report 12- General Dowel Equations for Calculating Lateral Connection Values, published by the American Wood Council

Wood Screw Type= 5/16" Lag Screw  
 Wood Screw Length= 2.00 in  
 Wood Screw Embedment= 1.50 in  
 Wood Screw Thread Length= 1.50 in  
 D = 0.313 in , Dowel Diameter  
 D<sub>m</sub> = 0.227 in , Dowel Diameter at max. stress in main member  
 D<sub>s</sub> = 0.227 in , Dowel Diameter at max. stress in side member  
 F<sub>b</sub> = 60,000 psi , Dowel bending strength



**Wood Screw Withdrawal Calculations**

Substrate: Mixed Maple-Southern Pine  
 Tabulated withdrawal design value: W = 306 lbs  
 Penetration Factor: C<sub>p</sub> = 1.50 in  
 Duration Factor: C<sub>d</sub> = 1.60

**Withdrawal Allowable (W') = 734.0 lbs**

**Wood Screw Lateral Calculations - Solid Main Member - Solid Side Member**

Substrate (Main Member): Mixed Maple-Southern Pine  
 Frame (Side Member): Aluminum 6063-T6  
 Cantilever Distance: 0 in , Frame hollow space+ shim  
 ℓ<sub>m</sub> = 1.500 in , Main member dowel bearing length  
 ℓ<sub>s</sub> = 0.438 in , Side member dowel bearing length  
 F<sub>em</sub> = 4,586 psi , Main member dowel bearing strength  
 F<sub>es</sub> = 35,000 psi , Side member dowel bearing strength  
 q<sub>m</sub> = 1,041 lbs/in , Main member dowel bearing resistance = F<sub>em</sub>D<sub>m</sub>  
 q<sub>s</sub> = 7,945 lbs/in , Side member dowel bearing resistance = F<sub>es</sub>D<sub>s</sub>  
 M<sub>m</sub> = 116.97 in-lbs , Main member dowel moment resistance = F<sub>b</sub>(D<sub>m</sub><sup>3</sup>/6)  
 M<sub>s</sub> = 116.97 in-lbs , Side member dowel moment resistance = F<sub>b</sub>(D<sub>s</sub><sup>3</sup>/6)  
 θ = 90 degrees , Maximum angle of load to grain (0° ≤ θ ≤ 90°) for any member in a connection  
 K<sub>θ</sub> = 1.25  
 K<sub>D</sub> = 2.770

Project Description: Glass Warehouse LLC / FutureGlass – Fabrikasi Posted Glass Railing System	Date: January 30, 2025	Customer: Glass Warehouse LLC / FutureGlass	
		Project #: EEV-24-0628	
	Engineer: SH	PER: 9361	Page #: Page 17 of 39



YOU ENVISION IT – WE ENGINEER IT

1900 NE Miami Ct., Ste. 2-15  
 Miami, FL 33132  
 TEL: 954.399-8478 | FAX: 954.744.4738  
 WEB: [www.buildingdrops.com](http://www.buildingdrops.com)

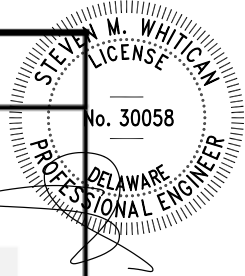

**5/16" Lag Screw into Mixed Maple-Southern Pine w/ 0 in. of Gap Space.**  
**Base Plate Installation**

Yield Limit Equations per Table 11.3.1A of ANSI/AWC NDS-2018 and Table 1-1 of Technical Report 12 from AWC

		Single Shear		Double Shear		
Mode I <sub>m</sub>	Z <sub>F</sub>	1561.52	lbs	1561.52	lbs	, Main Member Bearing
				5.00		, Reduction Term
<b>Mode I<sub>m</sub></b>	<b>Z<sub>F</sub></b>	<b>312.30</b>	<b>lbs</b>	<b>312.30</b>	<b>lbs</b>	
Mode I <sub>s</sub>	Z <sub>F</sub>	3440.19	lbs	6880.37	lbs	, Side Member Bearing
				5.00		, Reduction Term
<b>Mode I<sub>s</sub></b>	<b>Z<sub>F</sub></b>	<b>688.04</b>	<b>lbs</b>	<b>1376.07</b>	<b>lbs</b>	
Mode II	Z <sub>IF</sub>	807.79	lbs			, Side and Main Member Bearing
	A =	0.0003				
	B =	0.967				
	C =	-957.97				
				4.50		, Reduction Term
<b>Mode II</b>	<b>Z<sub>IF</sub></b>	<b>179.51</b>	<b>lbs</b>			
Mode III <sub>m</sub>	Z <sub>IF</sub>	724.57	lbs			, Main Member Bearing and Dowel
	A =	0.0003				Yielding in the Side Member
	B =	0.750				
	C =	-702.54				
				4.00		, Reduction Term
<b>Mode III<sub>m</sub></b>	<b>Z<sub>IF</sub></b>	<b>181.14</b>	<b>lbs</b>			
Mode III <sub>s</sub>	Z <sub>IF</sub>	788.97	lbs	1577.93	lbs	, Side Member Bearing and Dowel
	A =	0.0005				Yielding in the Main Member
	B =	0.217				
	C =	-489.37				
				4.00		, Reduction Term
<b>Mode III<sub>s</sub></b>	<b>Z<sub>IF</sub></b>	<b>197.24</b>	<b>lbs</b>	<b>394.48</b>	<b>lbs</b>	
Mode IV	Z <sub>IF</sub>	656.24	lbs	1312.47	lbs	, Dowel Yielding in the Side and Main
	A =	0.0005				Member
	B =	0.000				
	C =	-233.94				
				4.00		, Reduction Term
<b>Mode IV</b>	<b>Z<sub>IF</sub></b>	<b>164.06</b>	<b>lbs</b>	<b>328.12</b>	<b>lbs</b>	

C<sub>d</sub> = 1.6 , Load Duration  
 C<sub>p</sub> = 1.000 , Penetration Factor

**Single Lateral Allowable (Z'<sub>s</sub>) = 262.495 lbs**

Project Description: Glass Warehouse LLC / FutureGlass – Fabrikasi Posted Glass Railing System	Date: January 30, 2025	Customer: Glass Warehouse LLC / FutureGlass	
	Engineer: SH	Project #: EEV-24-0628	
		PER: 9361	Page #: Page 18 of 39

**3/8" Lag Screw into Mixed Maple-Southern Pine w/ 0 in. of Gap Space.**

**Base Plate Installation**

Calculations herein are performed in accordance with the National Design Specification for Wood Construction - 2018, Chapter 12.3 and Technical Report 12- General Dowel Equations for Calculating Lateral Connection Values, published by the American Wood Council

Wood Screw Type= 3/8" Lag Screw  
 Wood Screw Length= 2.00 in  
 Wood Screw Embedment= 1.50 in  
 Wood Screw Thread Length= 1.50 in  
 D = 0.375 in , Dowel Diameter  
 D<sub>m</sub> = 0.265 in , Dowel Diameter at max. stress in main member  
 D<sub>s</sub> = 0.265 in , Dowel Diameter at max. stress in side member  
 F<sub>b</sub> = 45,000 psi , Dowel bending strength



**Wood Screw Withdrawal Calculations**

Substrate: Mixed Maple-Southern Pine  
 Tabulated withdrawal design value: W = 351 lbs  
 Penetration Factor: C<sub>p</sub> = 1.50 in  
 Duration Factor: C<sub>d</sub> = 1.60

**Withdrawal Allowable (W') = 842.0 lbs**

**Wood Screw Lateral Calculations - Solid Main Member - Solid Side Member**

Substrate (Main Member): Mixed Maple-Southern Pine  
 Frame (Side Member): Aluminum 6063-T6  
 Cantilever Distance: 0 in , Frame hollow space+ shim  
 ℓ<sub>m</sub> = 1.500 in , Main member dowel bearing length  
 ℓ<sub>s</sub> = 0.438 in , Side member dowel bearing length  
 F<sub>em</sub> = 4,186 psi , Main member dowel bearing strength  
 F<sub>es</sub> = 35,000 psi , Side member dowel bearing strength  
 q<sub>m</sub> = 1,109 lbs/in , Main member dowel bearing resistance = F<sub>em</sub>D<sub>m</sub>  
 q<sub>s</sub> = 9,275 lbs/in , Side member dowel bearing resistance = F<sub>es</sub>D<sub>s</sub>  
 M<sub>m</sub> = 139.57 in-lbs , Main member dowel moment resistance = F<sub>b</sub>(D<sub>m</sub><sup>3</sup>/6)  
 M<sub>s</sub> = 139.57 in-lbs , Side member dowel moment resistance = F<sub>b</sub>(D<sub>s</sub><sup>3</sup>/6)  
 θ = 90 degrees , Maximum angle of load to grain (0° ≤ θ ≤ 90°) for any member in a connection  
 K<sub>θ</sub> = 1.25  
 K<sub>D</sub> = N/A

Project Description: Glass Warehouse LLC / FutureGlass – Fabrikasi Posted Glass Railing System	Date: January 30, 2025	Customer: Glass Warehouse LLC / FutureGlass	
		Project #: EEV-24-0628	
	Engineer: SH	PER: 9361	Page #: Page 19 of 39



YOU ENVISION IT – WE ENGINEER IT

1900 NE Miami Ct., Ste. 2-15  
 Miami, FL 33132  
 TEL: 954.399-8478 | FAX: 954.744.4738  
 WEB: [www.buildingdrops.com](http://www.buildingdrops.com)

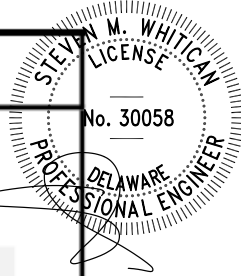

**3/8" Lag Screw into Mixed Maple-Southern Pine w/ 0 in. of Gap Space.**  
**Base Plate Installation**

Yield Limit Equations per Table 11.3.1A of ANSI/AWC NDS-2018 and Table 1-1 of Technical Report 12 from AWC

		Single Shear		Double Shear		
Mode I <sub>m</sub>	Z <sub>F</sub>	1664.09	lbs	1664.09	lbs	, Main Member Bearing , Reduction Term
<b>Mode I<sub>m</sub></b>	<b>Z<sub>F</sub></b>	<b>332.82</b>	<b>lbs</b>	<b>332.82</b>	<b>lbs</b>	
Mode I <sub>s</sub>	Z <sub>F</sub>	4016.08	lbs	8032.15	lbs	, Side Member Bearing , Reduction Term
<b>Mode I<sub>s</sub></b>	<b>Z<sub>F</sub></b>	<b>803.22</b>	<b>lbs</b>	<b>1606.43</b>	<b>lbs</b>	
Mode II	Z <sub>F</sub>	889.11	lbs			, Side and Main Member Bearing
	A =	0.0003				
	B =	0.967				
	C =	-1058.77				
				4.50		, Reduction Term
<b>Mode II</b>	<b>Z<sub>F</sub></b>	<b>197.58</b>	<b>lbs</b>			
Mode III <sub>m</sub>	Z <sub>II</sub>	787.33	lbs			, Main Member Bearing and Dowel Yielding in the Side Member
	A =	0.0003				
	B =	0.750				
	C =	-763.61				
				4.00		, Reduction Term
<b>Mode III<sub>m</sub></b>	<b>Z<sub>II</sub></b>	<b>196.83</b>	<b>lbs</b>			
Mode III <sub>s</sub>	Z <sub>II</sub>	898.07	lbs	1786.14	lbs	, Side Member Bearing and Dowel Yielding in the Main Member
	A =	0.0005				
	B =	0.217				
	C =	-574.31				
				4.00		, Reduction Term
<b>Mode III<sub>s</sub></b>	<b>Z<sub>II</sub></b>	<b>223.27</b>	<b>lbs</b>	<b>446.54</b>	<b>lbs</b>	
Mode IV	Z <sub>IV</sub>	743.77	lbs	1487.54	lbs	, Dowel Yielding in the Side and Main Member
	A =	0.0005				
	B =	0.000				
	C =	-279.14				
				4.00		, Reduction Term
<b>Mode IV</b>	<b>Z<sub>IV</sub></b>	<b>185.94</b>	<b>lbs</b>	<b>371.89</b>	<b>lbs</b>	

C<sub>d</sub> = 1.6 , Load Duration  
 C<sub>p</sub> = 1.000 , Penetration Factor

**Single Lateral Allowable (Z'<sub>L</sub>) = 297.508 lbs**

Project Description: Glass Warehouse LLC / FutureGlass – Fabrikasi Posted Glass Railing System	Date: January 30, 2025	Customer: Glass Warehouse LLC / FutureGlass	
		Project #: EEV-24-0628	
	Engineer: SH	PER: 9361	Page #: Page 20 of 39

**1/2" Lag Screw into Mixed Maple-Southern Pine w/0 in. of Gap Space.**

**Base Plate Installation**

Calculations herein are performed in accordance with the National Design Specification for Wood Construction - 2018, Chapter 12.3 and Technical Report 12- General Dowel Equations for Calculating Lateral Connection Values, published by the American Wood Council

Wood Screw Type= 1/2" Lag Screw  
 Wood Screw Length= 2.00 in  
 Wood Screw Embedment= 1.50 in  
 Wood Screw Thread Length= 1.50 in  
 D = 0.500 in , Dowel Diameter  
 D<sub>m</sub> = 0.371 in , Dowel Diameter at max. stress in main member  
 D<sub>s</sub> = 0.371 in , Dowel Diameter at max. stress in side member  
 F<sub>b</sub> = 45,000 psi , Dowel bending strength

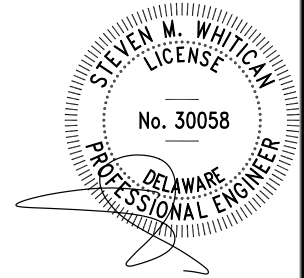

**Wood Screw Withdrawal Calculations**

Substrate: Mixed Maple-Southern Pine  
 Tabulated withdrawal design value: W = 436 lbs  
 Penetration Factor: C<sub>p</sub> = 1.50 in  
 Duration Factor: C<sub>d</sub> = 1.60

**Withdrawal Allowable (W') = 1046.0 lbs**

**Wood Screw Lateral Calculations - Solid Main Member - Solid Side Member**

Substrate (Main Member): Mixed Maple-Southern Pine  
 Frame (Side Member): Aluminum 6063-T6  
 Cantilever Distance: 0 in , Frame hollow space+ shim  
 ℓ<sub>m</sub> = 1.500 in , Main member dowel bearing length  
 ℓ<sub>s</sub> = 0.438 in , Side member dowel bearing length  
 F<sub>em</sub> = 3,626 psi , Main member dowel bearing strength  
 F<sub>es</sub> = 35,000 psi , Side member dowel bearing strength  
 q<sub>m</sub> = 1,345 lbs/in , Main member dowel bearing resistance = F<sub>em</sub>D<sub>m</sub>  
 q<sub>s</sub> = 12,985 lbs/in , Side member dowel bearing resistance = F<sub>es</sub>D<sub>s</sub>  
 M<sub>m</sub> = 382.99 in-lbs , Main member dowel moment resistance = F<sub>b</sub>(D<sub>m</sub><sup>3</sup>/6)  
 M<sub>s</sub> = 382.99 in-lbs , Side member dowel moment resistance = F<sub>b</sub>(D<sub>s</sub><sup>3</sup>/6)  
 θ = 90 degrees , Maximum angle of load to grain (0° ≤ θ ≤ 90°) for any member in a connection  
 K<sub>θ</sub> = 1.25  
 K<sub>D</sub> = N/A

Project Description: Glass Warehouse LLC / FutureGlass – Fabrikasi Posted Glass Railing System	Date: January 30, 2025	Customer: Glass Warehouse LLC / FutureGlass	
		Project #: EEV-24-0628	
	Engineer: SH	PER: 9361	Page #: Page 21 of 39



YOU ENVISION IT – WE ENGINEER IT

1900 NE Miami Ct., Ste. 2-15  
 Miami, FL 33132  
 TEL: 954.399-8478 | FAX: 954.744.4738  
 WEB: [www.buildingdrops.com](http://www.buildingdrops.com)

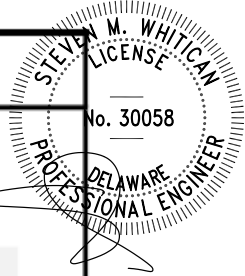

**1/2" Lag Screw into Mixed Maple-Southern Pine w/ 0 in. of Gap Space.**  
**Base Plate Installation**

Yield Limit Equations per Table 11.3.1A of ANSI/AWC NDS-2018 and Table 1-1 of Technical Report 12 from AWC

		Single Shear		Double Shear		
Mode I <sub>m</sub>	Z <sub>F</sub>	2017.60	lbs	2017.60	lbs	, Main Member Bearing
				5.00		, Reduction Term
<b>Mode I<sub>m</sub></b>	<b>Z<sub>F</sub></b>	<b>403.52</b>	<b>lbs</b>	<b>403.52</b>	<b>lbs</b>	
Mode I <sub>s</sub>	Z <sub>F</sub>	5622.51	lbs	11245.01	lbs	, Side Member Bearing
				5.00		, Reduction Term
<b>Mode I<sub>s</sub></b>	<b>Z<sub>F</sub></b>	<b>1124.50</b>	<b>lbs</b>	<b>2249.00</b>	<b>lbs</b>	
Mode II	Z <sub>IF</sub>	1137.81	lbs			, Side and Main Member Bearing
	A =	0.0002				
	B =	0.967				
	C =	-1365.24				
				4.50		, Reduction Term
<b>Mode II</b>	<b>Z<sub>IF</sub></b>	<b>252.85</b>	<b>lbs</b>			
Mode III <sub>m</sub>	Z <sub>IF</sub>	1134.44	lbs			, Main Member Bearing and Dowel
	A =	0.0002				Yielding in the Side Member
	B =	0.750				
	C =	-1139.59				
				4.00		, Reduction Term
<b>Mode III<sub>m</sub></b>	<b>Z<sub>IF</sub></b>	<b>283.61</b>	<b>lbs</b>			
Mode III <sub>s</sub>	Z <sub>IF</sub>	1339.58	lbs	2679.16	lbs	, Side Member Bearing and Dowel
	A =	0.0004				Yielding in the Main Member
	B =	0.217				
	C =	-991.62				
				4.00		, Reduction Term
<b>Mode III<sub>s</sub></b>	<b>Z<sub>IF</sub></b>	<b>334.89</b>	<b>lbs</b>	<b>669.79</b>	<b>lbs</b>	
Mode IV	Z <sub>IF</sub>	1366.44	lbs	2732.88	lbs	, Dowel Yielding in the Side and Main
	A =	0.0004				Member
	B =	0.000				
	C =	-765.97				
				4.00		, Reduction Term
<b>Mode IV</b>	<b>Z<sub>IF</sub></b>	<b>341.61</b>	<b>lbs</b>	<b>683.22</b>	<b>lbs</b>	

C<sub>d</sub> = 1.6 , Load Duration  
 C<sub>p</sub> = 1.000 , Penetration Factor

**Single Lateral Allowable (Z'<sub>s</sub>) = 404.554 lbs**

Project Description: Glass Warehouse LLC / FutureGlass – Fabrikasi Posted Glass Railing System	Date: January 30, 2025	Customer: Glass Warehouse LLC / FutureGlass	
		Project #: EEV-24-0628	
	Engineer: SH	PER: 9361	Page #: Page 22 of 39

**E4.3.1 Shear Strength Limited by Tilting and Bearing: 5/16" Self-Tapping Screw**

Reference: AISI Cold Formed Steel Specifications, E4.3.1

The nominal shear strength [resistance] per screw,  $P_{ns}$ , shall be determined in accordance with this section.

For  $t_2/t_1 \leq 1.0$ ,  $P_{ns}$  shall be taken as the smallest of

$P_{ns} = 4.2 (t_2^3 d)^{1/2} F_{u2}$  (Eq. E4.3.1-1)  
 $P_{ns} = 2.7 t_1 d F_{u1}$  (Eq. E4.3.1-2)  
 $P_{ns} = 2.7 t_2 d F_{u2}$  (Eq. E4.3.1-3)

For  $t_2/t_1 \geq 2.5$ ,  $P_{ns}$  shall be taken as the smaller of

$P_{ns} = 2.7 t_1 d F_{u1}$  (Eq. E4.3.1-4)  
 $P_{ns} = 2.7 t_2 d F_{u2}$  (Eq. E4.3.1-5)

For  $1.0 < t_2/t_1 < 2.5$ ,  $P_{ns}$  shall be calculated by linear interpolation between the above two cases.

Figure 1: Typical Connection Detail

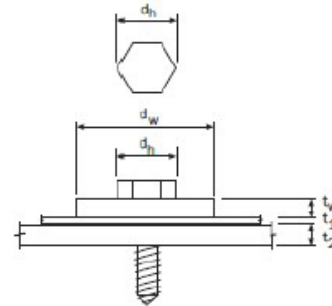

Where,

Nominal screw diameter,

$d = 0.3125$  in.

Thickness of member in contact with screw head,

$t_1 = 0.433$  in.

Thickness of member not in contact with screw head,

$t_2 = 0.125$  in.

Ratio of thickness,

$t_2/t_1 = 0.28868$

Tensile strength of mem. in contact with screw head,

$F_{u1} = 35000$  psi

Tensile strength of mem. not in contact with screw head,

$F_{u2} = 45000$  psi

Eq. E4.3.1-1,

$P_{ns} = 4669.3$  lbs

Eq. E4.3.1-2,

$P_{ns} = 12787$  lbs

Eq. E4.3.1-3,

$P_{ns} = 4746.09$  lbs

Eq. E4.3.1-4,

$P_{ns} = 12787$  lbs

Eq. E4.3.1-5,

$P_{ns} = 4746.09$  lbs

For  $t_2/t_1 \leq 1.0$ ,

$P_{ns} = 4669.3$  lbs

**Use This Value**

For  $t_2/t_1 \geq 2.5$ ,

$P_{ns} = 4746.09$  lbs

**Not Applicable**

For  $1.0 < t_2/t_1 < 2.5$ ,

$P_{ns} = 4632.88$  lbs

**Not Applicable**

Per ASD,

$P_{ns}/\Omega = 1556.43$  lbs,  $\Omega = 3$

Per LRFD,

$\Phi P_{ns} = 2334.65$  lbs,  $\Phi = 0.5$

**Check Shear Capacity of Screw.**

5/16" Self Tapping Screw,

$D = 0.3125$  in.

$P_n/\Omega = 1299$  lbs, per AAMATIR A9-14

**Check Combined Bending & Shear.**

Nom. Diameter,  $D = 0.313$  in.  $S = 0.0030$  in.<sup>3</sup>  $A = 0.0767$  in.<sup>2</sup>

Screw Strength,  $F_u = 120.0$  ksi  $F_y = 92.0$  ksi  $F_v = 27$  ksi  $F_b = 45.0$  ksi

Gap Screw,  $g = 0.0$

Eff. Cantilever,  $d = 0.00$  in.

Allowable Load,  $R_n/\Omega = 2070.9$  lbs (based on unity equation)

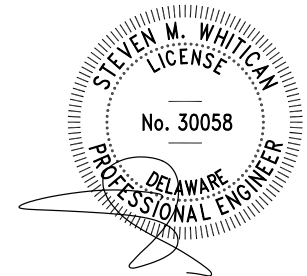

Project Description: Glass Warehouse LLC / FutureGlass – Fabrikasi Posted Glass Railing System	Date: January 30, 2025	Customer: Glass Warehouse LLC / FutureGlass	
	Engineer: SH	Project #: EEV-24-0628	
	PER: 9361	Page #: Page 23 of 39	

**E4.4.1 Pull-Out Strength: 5/16" Self-Tapping Screw**

Reference: AISI Cold Formed Steel Specifications, E4.4.1

**E4.4.1 Pull-Out Strength [Resistance]**

The nominal pull-out strength [resistance],  $P_{not}$ , shall be calculated as follows:  
 $P_{not} = 0.85 t_c d F_{u2}$  (Eq. E4.4.1-1)

Same formula is referenced in AAMA TIR A9-14 for thickness of 1/4" or less.

Figure 1: Typical Connection Detail

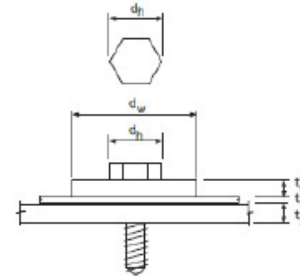

Where,

Nominal screw diameter,

$d = 0.3125$  in.

Thickness of member in contact with screw head,

$t_1 = 0.433$  in.

Thickness of member not in contact with screw head,

$t_2 = 0.125$  in.

Tensile strength of mem. not in contact with screw head,

$F_{u2} = 65000$  psi

Eq. E4.4.1

$P_{not} = 2158.2$  lbs

Per ASD,

$P_{ns}/\Omega = 719.401$  lbs,  $\Omega = 3$

Per LRFD,

$\Phi P_{ns} = 1079.1$  lbs,  $\Phi = 0.5$

**E4.4.2 Pull-Over Strength**

Reference: AISI Cold Formed Steel Specifications, E4.4.2

$P_{nov} = 1.5 * t_1 * d_w * F_{u1}$  (Eq. E4.4.2-1)

Where,

Thickness of member in contact with screw head,

$t_1 = 0.433$  in.

Tensile strength of mem. in contact with screw head,

$F_{u1} = 35000$  psi

Effective Pull-over Diameter,

$d_w = 0.625$  in.

Eq. E4.4.2-1

Per ASD,

$P_{ns}/\Omega = 4735.94$  lbs,  $\Omega = 3$

Per LRFD,

$\Phi P_{ns} = 7103.91$  lbs,  $\Phi = 0.5$

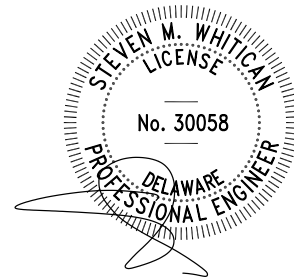

**Check Tensile Capacity of Screw.**

5/16" Self Tapping Screw,

$D = 0.3125$  in.

$P_n/\Omega = 2517$  lbs, per AAMA TIR A9-14

**Design Value**

$T = 719.401$  lbs

Project Description: Glass Warehouse LLC / FutureGlass – Fabrikasi Posted Glass Railing System	Date: January 30, 2025	Customer: Glass Warehouse LLC / FutureGlass	
		Project #: EEV-24-0628	
	Engineer: SH	PER: 9361	Page #: Page 24 of 39

**E4.3.1 Shear Strength Limited by Tilting and Bearing: 3/8" Self-Tapping Screw**

Reference: AISI Cold Formed Steel Specifications, E4.3.1

The nominal shear strength [resistance] per screw,  $P_{ns}$ , shall be determined in accordance with this section.

For  $t_2/t_1 \leq 1.0$ ,  $P_{ns}$  shall be taken as the smallest of

$P_{ns} = 4.2 (t_2^3 d)^{1/2} F_{u2}$  (Eq. E4.3.1-1)  
 $P_{ns} = 2.7 t_1 d F_{u1}$  (Eq. E4.3.1-2)  
 $P_{ns} = 2.7 t_2 d F_{u2}$  (Eq. E4.3.1-3)

For  $t_2/t_1 \geq 2.5$ ,  $P_{ns}$  shall be taken as the smaller of

$P_{ns} = 2.7 t_1 d F_{u1}$  (Eq. E4.3.1-4)  
 $P_{ns} = 2.7 t_2 d F_{u2}$  (Eq. E4.3.1-5)

For  $1.0 < t_2/t_1 < 2.5$ ,  $P_{ns}$  shall be calculated by linear interpolation between the above two cases.

Figure 1: Typical Connection Detail

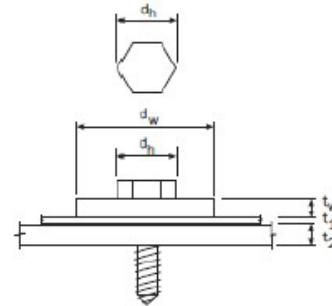

Where,

Nominal screw diameter,

$d = 0.375$  in.

Thickness of member in contact with screw head,

$t_1 = 0.433$  in.

Thickness of member not in contact with screw head,

$t_2 = 0.125$  in.

Ratio of thickness,

$t_2/t_1 = 0.28868$

Tensile strength of mem. in contact with screw head,

$F_{u1} = 35000$  psi

Tensile strength of mem. not in contact with screw head,

$F_{u2} = 45000$  psi

- Eq. E4.3.1-1,
- Eq. E4.3.1-2,
- Eq. E4.3.1-3,
- Eq. E4.3.1-4,
- Eq. E4.3.1-5,

- $P_{ns} = 5114.96$  lbs
- $P_{ns} = 15344.4$  lbs
- $P_{ns} = 5695.31$  lbs
- $P_{ns} = 15344.4$  lbs
- $P_{ns} = 5695.31$  lbs

For  $t_2/t_1 \leq 1.0$ ,

$P_{ns} = 5114.96$  lbs

**Use This Value**

For  $t_2/t_1 \geq 2.5$ ,

$P_{ns} = 5695.31$  lbs

**Not Applicable**

For  $1.0 < t_2/t_1 < 2.5$ ,

$P_{ns} = 4839.75$  lbs

**Not Applicable**

Per ASD,

$P_{ns}/\Omega = 1704.99$  lbs,  $\Omega = 3$

Per LRFD,

$\Phi P_{ns} = 2557.48$  lbs,  $\Phi = 0.5$

**Check Shear Capacity of Screw.**

3/8" Self Tapping Screw,

$D = 0.375$  in.

$P_n/\Omega = 1937$  lbs, per AAMATIR A9-14

**Check Combined Bending & Shear.**

Nom. Diameter,  $D = 0.375$  in.  $S = 0.0052$  in.<sup>3</sup>  $A = 0.11045$  in.<sup>2</sup>

Screw Strength,  $F_u = 120.0$  ksi  $F_y = 92.0$  ksi  $F_v = 27$  ksi  $F_b = 45.0$  ksi

Gap Screw,  $g = 0.0$

Eff. Cantilever,  $d = 0.00$  in.

Allowable Load,  $R_n/\Omega = 2982.1$  lbs (based on unity equation)



Project Description: Glass Warehouse LLC / FutureGlass – Fabrikasi Posted Glass Railing System	Date: January 30, 2025	Customer: Glass Warehouse LLC / FutureGlass	
	Engineer: SH	Project #: EEV-24-0628	
	PER: 9361	Page #: Page 25 of 39	

**E4.4.1 Pull-Out Strength: 3/8" Self-Tapping Screw**

Reference: AISI Cold Formed Steel Specifications, E4.4.1

**E4.4.1 Pull-Out Strength [Resistance]**

The nominal pull-out strength [resistance],  $P_{not}$ , shall be calculated as follows:  
 $P_{not} = 0.85 t_c d F_{u2}$  (Eq. E4.4.1-1)

Same formula is referenced in AAMA TIR A9-14 for thickness of 1/4" or less.

Figure 1: Typical Connection Detail

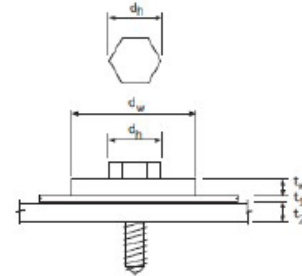

Where,

Nominal screw diameter,

$d = 0.375$  in.

Thickness of member in contact with screw head,

$t_1 = 0.433$  in.

Thickness of member not in contact with screw head,

$t_2 = 0.125$  in.

Tensile strength of mem. not in contact with screw head,

$F_{u2} = 65000$  psi

Eq. E4.4.1

$P_{not} = 2589.84$  lbs

Per ASD,

$P_{ns}/\Omega = 863.281$  lbs,  $\Omega = 3$

Per LRFD,

$\Phi P_{ns} = 1294.92$  lbs,  $\Phi = 0.5$

**E4.4.2 Pull-Over Strength**

Reference: AISI Cold Formed Steel Specifications, E4.4.2

$P_{nov} = 1.5 * t_1 * d_w * F_{u1}$  (Eq. E4.4.2-1)

Where,

Thickness of member in contact with screw head,

$t_1 = 0.433$  in.

Tensile strength of mem. in contact with screw head,

$F_{u1} = 35000$  psi

Effective Pullover Diameter,

$d_w = 0.625$  in.

Eq. E4.4.2-1

Per ASD,

$P_{ns}/\Omega = 4735.94$  lbs,  $\Omega = 3$

Per LRFD,

$\Phi P_{ns} = 7103.91$  lbs,  $\Phi = 0.5$

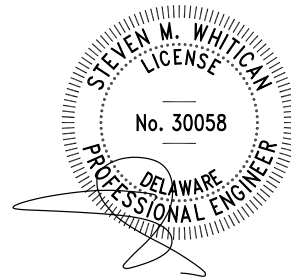

**Check Tensile Capacity of Screw.**

3/8" Self Tapping Screw,

$D = 0.375$  in.

$P_n/\Omega = 3719$  lbs, per AAMA TIR A9-14

**Design Value**

$T = 863.281$  lbs

Project Description: Glass Warehouse LLC / FutureGlass – Fabrikasi Posted Glass Railing System	Date: January 30, 2025	Customer: Glass Warehouse LLC / FutureGlass	
	Engineer: SH	Project #: EEV-24-0628	
	PER: 9361	Page #: Page 26 of 39	

**E4.3.1 Shear Strength Limited by Tilting and Bearing: 1/2" Self-Tapping Screw**

Reference: AISI Cold Formed Steel Specifications, E4.3.1

The nominal shear strength [resistance] per screw,  $P_{ns}$ , shall be determined in accordance with this section.

For  $t_2/t_1 \leq 1.0$ ,  $P_{ns}$  shall be taken as the smallest of

$P_{ns} = 4.2 (t_2^3 d)^{1/2} F_{u2}$  (Eq. E4.3.1-1)

$P_{ns} = 2.7 t_1 d F_{u1}$  (Eq. E4.3.1-2)

$P_{ns} = 2.7 t_2 d F_{u2}$  (Eq. E4.3.1-3)

For  $t_2/t_1 \geq 2.5$ ,  $P_{ns}$  shall be taken as the smaller of

$P_{ns} = 2.7 t_1 d F_{u1}$  (Eq. E4.3.1-4)

$P_{ns} = 2.7 t_2 d F_{u2}$  (Eq. E4.3.1-5)

For  $1.0 < t_2/t_1 < 2.5$ ,  $P_{ns}$  shall be calculated by linear interpolation between the above two cases.

Figure 1: Typical Connection Detail

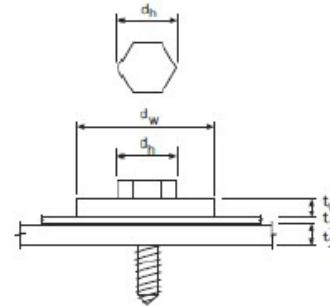

Where,

Nominal screw diameter,

$d = 0.5$  in.

Thickness of member in contact with screw head,

$t_1 = 0.433$  in.

Thickness of member not in contact with screw head,

$t_2 = 0.125$  in.

Ratio of thickness,

$t_2/t_1 = 0.28868$

Tensile strength of mem. in contact with screw head,

$F_{u1} = 35000$  psi

Tensile strength of mem. not in contact with screw head,

$F_{u2} = 45000$  psi

Eq. E4.3.1-1,

$P_{ns} = 5906.25$  lbs

Eq. E4.3.1-2,

$P_{ns} = 20459.3$  lbs

Eq. E4.3.1-3,

$P_{ns} = 7593.75$  lbs

Eq. E4.3.1-4,

$P_{ns} = 20459.3$  lbs

Eq. E4.3.1-5,

$P_{ns} = 7593.75$  lbs

For  $t_2/t_1 \leq 1.0$ ,

$P_{ns} = 5906.25$  lbs

**Use This Value**

For  $t_2/t_1 \geq 2.5$ ,

$P_{ns} = 7593.75$  lbs

**Not Applicable**

For  $1.0 < t_2/t_1 < 2.5$ ,

$P_{ns} = 5106.02$  lbs

**Not Applicable**

Per ASD,

$P_{ns}/\Omega = 1968.75$  lbs,  $\Omega = 3$

Per LRFD,

$\Phi P_{ns} = 2953.13$  lbs,  $\Phi = 0.5$

**Check Shear Capacity of Screw.**

1/2" Self Tapping Screw,

$D = 0.5$  in.

$P_n/\Omega = 3581$  lbs, per AAMA TIR A9-14

**Check Combined Bending & Shear.**

Nom. Diameter,  $D = 0.500$  in.  $S = 0.0123$  in.<sup>3</sup>  $A = 0.19635$  in.<sup>2</sup>

Screw Strength,  $F_u = 120.0$  ksi  $F_y = 92.0$  ksi  $F_v = 27$  ksi  $F_b = 45.0$  ksi

Gap Screw,  $g = 0.0$

Eff. Cantilever,  $d = 0.00$  in.

Allowable Load,  $R_n/\Omega = 5301.4$  lbs (based on unity equation)

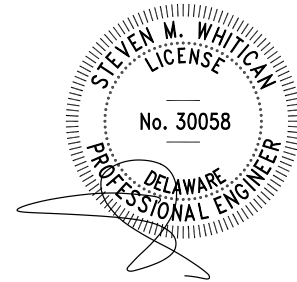

Project Description: Glass Warehouse LLC / FutureGlass – Fabrikasi Posted Glass Railing System	Date: January 30, 2025	Customer: Glass Warehouse LLC / FutureGlass	
	Engineer: SH	Project #: EEV-24-0628	
	PER: 9361	Page #: Page 27 of 39	

**E4.4.1 Pull-Out Strength: 1/2" Self-Tapping Screw**

Reference: AISI Cold Formed Steel Specifications, E4.4.1

**E4.4.1 Pull-Out Strength [Resistance]**

The nominal pull-out strength [resistance],  $P_{not}$ , shall be calculated as follows:  
 $P_{not} = 0.85 t_c d F_{u2}$  (Eq. E4.4.1-1)

Same formula is referenced in AAMA TIR A9-14 for thickness of 1/4" or less.

Figure 1: Typical Connection Detail

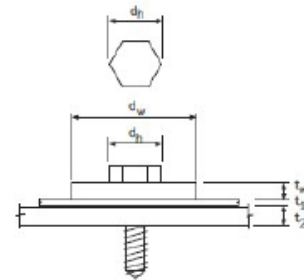

Where,

Nominal screw diameter,

$d = 0.5$  in.

Thickness of member in contact with screw head,

$t_1 = 0.433$  in.

Thickness of member not in contact with screw head,

$t_2 = 0.125$  in.

Tensile strength of mem. not in contact with screw head,

$F_{u2} = 65000$  psi

Eq. E4.4.1

$P_{not} = 3453.13$  lbs

Per ASD,

$P_{ns}/\Omega = 1151.04$  lbs,  $\Omega = 3$

Per LRFD,

$\Phi P_{ns} = 1726.56$  lbs,  $\Phi = 0.5$

**E4.4.2 Pull-Over Strength**

Reference: AISI Cold Formed Steel Specifications, E4.4.2

$P_{nov} = 1.5 * t_1 * d_w * F_{u1}$  (Eq. E4.4.2-1)

Where,

Thickness of member in contact with screw head,

$t_1 = 0.433$  in.

Tensile strength of mem. in contact with screw head,

$F_{u1} = 35000$  psi

Effective Pull-over Diameter,

$d_w = 0.625$  in.

Eq. E4.4.2-1

$P_{ns}/\Omega = 4735.94$  lbs,  $\Omega = 3$

Per ASD,

Per LRFD,

$\Phi P_{ns} = 7103.91$  lbs,  $\Phi = 0.5$

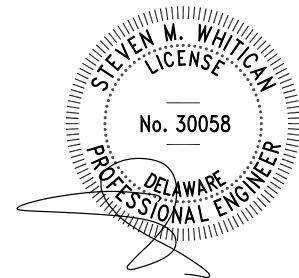

**Check Tensile Capacity of Screw.**

1/2" Self Tapping Screw,

$D = 0.5$  in.

$P_n/\Omega = 6811$  lbs, per AAMA TIR A9-14

**Design Value**

$T = 1151.04$  lbs

Project Description: Glass Warehouse LLC / FutureGlass – Fabrikasi Posted Glass Railing System	Date: January 30, 2025	Customer: Glass Warehouse LLC / FutureGlass	
		Project #: EEV-24-0628	
	Engineer: SH	PER: 9361	Page #: Page 28 of 39



YOU ENVISION IT – WE ENGINEER IT

1900 NE Miami Ct., Ste. 2-15  
 Miami, FL 33132  
 TEL: 954.399-8478 | FAX: 954.744.4738  
 WEB: [www.buildingdrops.com](http://www.buildingdrops.com)

Product Evaluation Report			
Manufacture: Glass Warehouse			
Product: Fabrikasi Posted Glass Railing			
Tension Design Value			
Concrete Anchor Calculations		Masonry Anchor Calculations	
Fastener type: 1/4" Dewalt Screw-Bolt+		Fastener type: 1/4" Dewalt Screw-Bolt+	
Reference: Manufacturer Published Data		Reference: Manufacturer Published Data	
Substrate: 3000 PSI Concrete or Greater		Substrate: Hollow Block CMU (Per ASTM C-90)	
Minimum embedment:	2.50 in	Minimum embedment:	- in
Minimum Spacing:	3.00 in	Minimum Spacing:	- in
Minimum edge distance:	3.00 in	Minimum edge distance:	- in
Allowable Design Value:	$W = 647$ lbs / anchor	Allowable Design Value:	$W' = -$ lbs / anchor
Shear Design Value			
Concrete Anchor Calculations		Masonry Anchor Calculations	
Fastener type: 1/4" Dewalt Screw-Bolt+		Fastener type: 1/4" Dewalt Screw-Bolt+	
Reference: Manufacturer Published Data		Reference: Manufacturer Published Data	
Substrate: 3000 PSI Concrete or Greater		Substrate: Hollow Block CMU (Per ASTM C-90)	
Minimum embedment:	2.50 in	Minimum embedment:	- in
Minimum Spacing:	3.00 in	Minimum Spacing:	- in
Minimum edge distance:	3.00 in	Minimum edge distance:	- in
Allowable Design Value:	$Z' = 375$ lbs / anchor	Allowable Design Value:	$Z' = -$ lbs / anchor

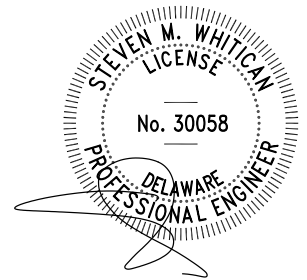

Project Description: Glass Warehouse LLC / FutureGlass – Fabrikasi Posted Glass Railing System	Date: January 30, 2025	Customer: Glass Warehouse LLC / FutureGlass	
	Engineer: SH	Project #: EEV-24-0628	
		PER: 9361	Page #: Page 29 of 39



<b>Product Evaluation Report</b>			
<b>Manufacture: Glass Warehouse</b>			
<b>Product: Fabrikasi Posted Glass Railing</b>			
Tension Design Value			
Concrete Anchor Calculations		Masonry Anchor Calculations	
Fastener type: 3/8" Dewalt Screw-Bolt+		Fastener type: 3/8" Dewalt Screw-Bolt+	
Reference: Manufacturer Published Data		Reference: Manufacturer Published Data	
Substrate: 3000 PSI Concrete or Greater		Substrate: Hollow Block CMU (Per ASTM C-90)	
Minimum embedment: 2.50 in		Minimum embedment: - in	
Minimum Spacing: 3.00 in		Minimum Spacing: - in	
Minimum edge distance: 3.00 in		Minimum edge distance: - in	
Allowable Design Value: <b>W</b> = 1041 lbs / anchor		Allowable Design Value: <b>W</b> ' = - lbs / anchor	
Shear Design Value			
Concrete Anchor Calculations		Masonry Anchor Calculations	
Fastener type: 3/8" Dewalt Screw-Bolt+		Fastener type: 3/8" Dewalt Screw-Bolt+	
Reference: Manufacturer Published Data		Reference: Manufacturer Published Data	
Substrate: 3000 PSI Concrete or Greater		Substrate: Hollow Block CMU (Per ASTM C-90)	
Minimum embedment: 2.50 in		Minimum embedment: - in	
Minimum Spacing: 3.00 in		Minimum Spacing: - in	
Minimum edge distance: 3.00 in		Minimum edge distance: - in	
Allowable Design Value: <b>Z</b> ' = 575 lbs / anchor		Allowable Design Value: <b>Z</b> ' = - lbs / anchor	



Project Description: Glass Warehouse LLC / FutureGlass – Fabrikasi Posted Glass Railing System	Date: January 30, 2025	Customer: Glass Warehouse LLC / FutureGlass	
		Project #: EEV-24-0628	
	Engineer: SH	PER: 9361	Page #: Page 30 of 39



YOU ENVISION IT – WE ENGINEER IT

1900 NE Miami Ct., Ste. 2-15  
 Miami, FL 33132  
 TEL: 954.399-8478 | FAX: 954.744.4738  
 WEB: [www.buildingdrops.com](http://www.buildingdrops.com)

Product Evaluation Report			
Manufacture: Glass Warehouse			
Product: Fabrikasi Posted Glass Railing			
Tension Design Value			
Concrete Anchor Calculations		Masonry Anchor Calculations	
Fastener type: 1/2" Dewalt Screw-Bolt+		Fastener type: 1/2" Dewalt Screw-Bolt+	
Reference: Manufacturer Published Data		Reference: Manufacturer Published Data	
Substrate: 3000 PSI Concrete or Greater		Substrate: Hollow Block CMU (Per ASTM C-90)	
Minimum embedment:	2.50 in	Minimum embedment:	- in
Minimum Spacing:	3.00 in	Minimum Spacing:	- in
Minimum edge distance:	3.00 in	Minimum edge distance:	- in
Allowable Design Value:	W <sup>t</sup> = 1347 lbs / anchor	Allowable Design Value:	W <sup>t</sup> = - lbs / anchor
Shear Design Value			
Concrete Anchor Calculations		Masonry Anchor Calculations	
Fastener type: 1/2" Dewalt Screw-Bolt+		Fastener type: 1/2" Dewalt Screw-Bolt+	
Reference: Manufacturer Published Data		Reference: Manufacturer Published Data	
Substrate: 3000 PSI Concrete or Greater		Substrate: Hollow Block CMU (Per ASTM C-90)	
Minimum embedment:	2.50 in	Minimum embedment:	- in
Minimum Spacing:	3.00 in	Minimum Spacing:	- in
Minimum edge distance:	3.00 in	Minimum edge distance:	- in
Allowable Design Value:	Z <sup>t</sup> = 700 lbs / anchor	Allowable Design Value:	Z <sup>t</sup> = - lbs / anchor

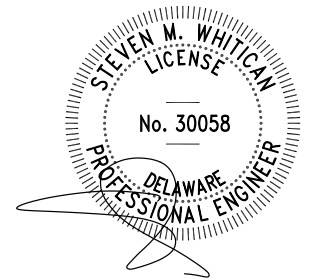

Project Description: Glass Warehouse LLC / FutureGlass – Fabrikasi Posted Glass Railing System	Date: January 30, 2025	Customer: Glass Warehouse LLC / FutureGlass	
	Engineer: SH	Project #: EEV-24-0628	
	PER: 9361	Page #: Page 31 of 39	

## Product Evaluation Report

**Manufacture:** Glass Warehouse  
**Product:** Fabrikasi Posted Glass Railing

### Manufacturer Published Data

#### Allowable Load Capacities for Screw-Bolt+ in Normal-Weight Concrete<sup>1,2,3,4,5</sup>



Nominal Diameter in.	Minimum Nominal Embedment Depth in. (mm)	Minimum Concrete Compressive Strength									
		F <sub>c</sub> = 2,500 psi (17.3 MPa)		F <sub>c</sub> = 3,000 psi (20.7 MPa)		F <sub>c</sub> = 4,000 psi (27.6 MPa)		F <sub>c</sub> = 6,000 psi (41.4 MPa)		F <sub>c</sub> = 8,000 psi (55.2 MPa)	
		Tension lbs (kN)	Shear lbs (kN)	Tension lbs (kN)	Shear lbs (kN)	Tension lbs (kN)	Shear lbs (kN)	Tension lbs (kN)	Shear lbs (kN)	Tension lbs (kN)	Shear lbs (kN)
1/4	1 (25)	330 (1.5)	415 (1.8)	350 (1.6)	440 (2.0)	385 (1.7)	480 (2.1)	430 (1.9)	520 (2.3)	430 (1.9)	520 (2.3)
	1-5/8 (41)	710 (3.2)	415 (1.8)	750 (3.3)	440 (2.0)	815 (3.6)	480 (2.1)	815 (3.6)	520 (2.3)	815 (3.6)	520 (2.3)
	2-1/2 (64)	915 (4.1)	505 (2.2)	965 (4.3)	535 (2.4)	1,050 (4.7)	585 (2.6)	1,070 (4.8)	635 (2.8)	1,070 (4.8)	635 (2.8)
3/8	1-1/2 (38)	660 (2.9)	890 (4.0)	720 (3.2)	975 (4.3)	835 (3.7)	1,125 (5.0)	1,020 (4.5)	1,375 (6.1)	1,020 (4.5)	1,590 (7.1)
	2 (51)	920 (4.1)	1,080 (4.8)	1,005 (4.5)	1,185 (5.3)	1,160 (5.2)	1,365 (6.1)	1,180 (5.2)	1,585 (7.1)	1,365 (6.1)	1,585 (7.1)
	2-1/2 (64)	1,295 (5.8)	1,080 (4.8)	1,415 (6.3)	1,185 (5.3)	1,600 (7.1)	1,365 (6.1)	1,815 (7.2)	1,585 (7.1)	1,855 (8.3)	1,585 (7.1)
	3-1/4 (83)	1,855 (8.3)	1,580 (7.0)	2,035 (9.1)	1,735 (7.7)	2,265 (10.1)	2,000 (8.9)	2,265 (10.1)	2,140 (9.5)	2,590 (11.5)	2,140 (9.5)
	4-1/2 (114)	2,725 (12.1)	1,580 (7.0)	2,985 (13.3)	1,735 (7.7)	3,450 (15.3)	2,000 (8.9)	3,770 (16.8)	2,140 (9.5)	3,770 (16.8)	2,140 (9.5)
1/2	1-3/4 (44)	710 (3.2)	1,495 (6.7)	780 (3.5)	1,640 (7.3)	900 (4.0)	1,895 (8.4)	1,100 (4.9)	2,320 (10.3)	1,100 (4.9)	2,675 (11.9)
	2-1/2 (64)	1,670 (7.4)	2,010 (8.9)	1,830 (8.1)	2,200 (9.8)	2,115 (9.4)	2,540 (11.3)	2,115 (9.4)	2,885 (12.8)	2,115 (9.4)	2,885 (12.8)
	3 (76)	2,140 (9.5)	2,010 (8.9)	2,345 (10.4)	2,200 (9.8)	2,690 (11.9)	2,540 (11.3)	2,690 (11.9)	2,885 (12.8)	2,690 (11.9)	2,885 (12.8)
	4-1/4 (108)	3,315 (14.7)	2,350 (10.5)	3,630 (16.1)	2,575 (11.5)	4,120 (18.3)	2,970 (13.2)	4,120 (18.3)	3,380 (15.0)	4,120 (18.3)	3,380 (15.0)
	5-1/2 (140)	3,935 (17.5)	2,350 (10.5)	4,310 (19.2)	2,575 (11.5)	4,975 (22.1)	2,970 (13.2)	5,330 (23.7)	3,380 (15.0)	5,330 (23.7)	3,380 (15.0)

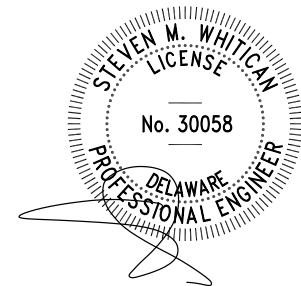

Project Description: Glass Warehouse LLC / FutureGlass – Fabrikasi Posted Glass Railing System	Date: January 30, 2025	Customer: Glass Warehouse LLC / FutureGlass	
	Engineer: SH	Project #: EEV-24-0628	Page #: Page 32 of 39
	PER: 9361		



YOU ENVISION IT – WE ENGINEER IT

1900 NE Miami Ct., Ste. 2-15  
 Miami, FL 33132  
 TEL: 954.399-8478 | FAX: 954.744.4738  
 WEB: [www.buildingdrops.com](http://www.buildingdrops.com)

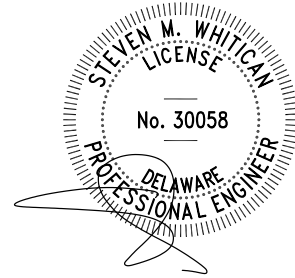

**5/16" Monolithic Tempered Glass - Supported Only by Posts**

- Glass Thickness = 5/16 in
- Minimum Thickness = 0.292 in
- Average Thickness = 0.313 in
- Glass Temper = Fully Tempered:
- Glass Moment of Inertia = 0.025 in<sup>4</sup>
- Glass Section Modulus = 0.171 in<sup>3</sup>
- Glass MOR (Fr) = 24000 lbs/in<sup>2</sup>
- Glass Allowable Bearing Stress = 6000 lbs/in<sup>2</sup>
- Allowable Stress (Wind Load) = 9600 lbs/in<sup>2</sup>
- Glass MOE = 10400000 lbs/in<sup>2</sup>
- Allowable Moment Live Loads, M<sub>L</sub> = 1023.17 in-lb/ft
- Allowable Moment Wind Load, M<sub>w</sub> = 1637.07 in-lb/ft

$$W = M_{aw} * 8 / L^2$$

Allowable Wind Load (PSF) - 5/16" Tempered Glass							
Post Spacing (in.)							
36.0	42.0	48.0	54.0	60.0	66.0	72.0	78.0
121.26	89.09	68.21	53.90	43.66	36.08	30.32	25.83

$$M_e = PL / (4 * H^{0.8})$$

Max. Post Spacing (in.) for 200lb Concentrated Load - 5/16" Tempered Glass							
Glass Height (in.)							
36.0	42.0	48.0	54.0	60.0	66.0	72.0	78.0
49.28	55.75	62.03	68.16	74.16	80.03	85.80	91.48

Max. Post Spacing (in.) for 50plf Live Load - 5/16" Tempered Glass							
Glass Height (in.)							
36.0	42.0	48.0	54.0	60.0	66.0	72.0	78.0
68.78	73.15	77.17	80.89	84.37	87.65	90.76	94.44

Allowable Wind Load Table (PSF) - 5/16" Tempered Glass								
Glass Height (in.)	Post Spacing (in.)							
	36.0	42.0	48.0	54.0	60.0	66.0	72.0	78.0
36.0	121.26	89.09	68.21	-	-	-	-	-
42.0	121.26	89.09	68.21	53.90	-	-	-	-
48.0	121.26	89.09	68.21	53.90	43.66	-	-	-
54.0	121.26	89.09	68.21	53.90	43.66	36.08	-	-
60.0	121.26	89.09	68.21	53.90	43.66	36.08	30.32	-

Project Description: Glass Warehouse LLC / FutureGlass – Fabrikasi Posted Glass Railing System	Date: January 30, 2025	Customer: Glass Warehouse LLC / FutureGlass	
	Engineer: SH	Project #: EEV-24-0628	
		PER: 9361	Page #: Page 33 of 39



YOU ENVISION IT – WE ENGINEER IT

1900 NE Miami Ct., Ste. 2-15  
 Miami, FL 33132  
 TEL: 954.399-8478 | FAX: 954.744.4738  
 WEB: [www.buildingdrops.com](http://www.buildingdrops.com)

**3/8" Monolithic Tempered Glass - Supported Only by Posts**

- Glass Thickness = 3/8 in
- Minimum Thickness = 0.355 in
- Average Thickness = 0.375 in
- Glass Temper = Fully Tempered
- Glass Moment of Inertia = 0.045 in<sup>4</sup>
- Glass Section Modulus = 0.252 in<sup>3</sup>
- Glass MOR (Fr) = 24000 lbs/in<sup>2</sup>
- Glass Allowable Bearing Stress = 6000 lbs/in<sup>2</sup>
- Allowable Stress (Wind Load) = 9600 lbs/in<sup>2</sup>
- Glass MOE = 10400000 lbs/in<sup>2</sup>
- Allowable Moment Live Loads, M<sub>L</sub> = 1512.30 in-lb/ft
- Allowable Moment Wind Load, M<sub>w</sub> = 2419.68 in-lb/ft

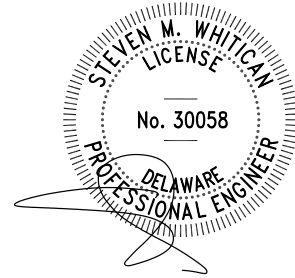

$$W = M_{aw} * 8 / L^2$$

Allowable Wind Load (PSF) - 3/8" Tempered Glass							
Post Spacing (in.)							
36.0	42.0	48.0	54.0	60.0	66.0	72.0	78.0
179.24	131.68	100.82	79.66	64.52	53.33	44.81	38.18

$$M_e = PL / (4 * H^{0.8})$$

Max. Post Spacing (in.) for 200lb Concentrated Load - 3/8" Tempered Glass							
Glass Height (in.)							
36.0	42.0	48.0	54.0	60.0	66.0	72.0	78.0
72.84	82.40	91.69	100.75	109.61	118.29	126.82	135.21

Max. Post Spacing (in.) for 50plf Live Load - 3/8" Tempered Glass							
Glass Height (in.)							
36.0	42.0	48.0	54.0	60.0	66.0	72.0	78.0
83.62	88.93	93.82	98.34	102.56	106.56	110.33	114.84

Allowable Wind Load Table (PSF) - 3/8" Tempered Glass								
Glass Height (in.)	Post Spacing (in.)							
	36.0	42.0	48.0	54.0	60.0	66.0	72.0	78.0
36.0	179.24	131.68	100.82	79.66	64.52	53.33	44.81	-
42.0	179.24	131.68	100.82	79.66	64.52	53.33	44.81	38.18
48.0	179.24	131.68	100.82	79.66	64.52	53.33	44.81	38.18
54.0	179.24	131.68	100.82	79.66	64.52	53.33	44.81	38.18
60.0	179.24	131.68	100.82	79.66	64.52	53.33	44.81	38.18

Project Description: Glass Warehouse LLC / FutureGlass – Fabrikasi Posted Glass Railing System	Date: January 30, 2025	Customer: Glass Warehouse LLC / FutureGlass	
	Engineer: SH	Project #: EEV-24-0628	
		PER: 9361	Page #: Page 34 of 39



YOU ENVISION IT – WE ENGINEER IT

1900 NE Miami Ct., Ste. 2-15  
 Miami, FL 33132  
 TEL: 954.399-8478 | FAX: 954.744.4738  
 WEB: [www.buildingdrops.com](http://www.buildingdrops.com)

**1/2" Monolithic Tempered Glass - Supported Only by Posts**

- Glass Thickness = 1/2 in
- Minimum Thickness = 0.469042 in
- Average Thickness = 0.500 in
- Glass Temper = Fully Tempered:
- Glass Moment of Inertia = 0.103 in<sup>4</sup>
- Glass Section Modulus = 0.440 in<sup>3</sup>
- Glass MOR (Fr) = 24000 lbs/in<sup>2</sup>
- Glass Allowable Bearing Stress = 6000 lbs/in<sup>2</sup>
- Allowable Stress (Wind Load) = 9600 lbs/in<sup>2</sup>
- Glass MOE = 10400000 lbs/in<sup>2</sup>
- Allowable Moment Live Loads, M<sub>L</sub> = 2640.00 in-lb/ft
- Allowable Moment Wind Load, M<sub>w</sub> = 4224.01 in-lb/ft



$$W = M_{aw} * 8 / L^2$$

Allowable Wind Load (PSF) - 1/2" Tempered Glass							
Post Spacing (in.)							
36.0	42.0	48.0	54.0	60.0	66.0	72.0	78.0
312.89	229.88	176.00	139.06	112.64	93.09	78.22	66.65

$$M_e = PL / (4 * H^{0.8})$$

Max. Post Spacing (in.) for 200lb Concentrated Load - 1/2" Tempered Glass							
Glass Height (in.)							
36.0	42.0	48.0	54.0	60.0	66.0	72.0	78.0
127.15	143.84	160.06	175.88	191.34	206.50	221.39	236.03

Max. Post Spacing (in.) for 50plf Live Load - 1/2" Tempered Glass							
Glass Height (in.)							
36.0	42.0	48.0	54.0	60.0	66.0	72.0	78.0
110.99	118.04	124.52	130.52	136.15	141.43	146.45	152.28

Allowable Wind Load Table (PSF) - 1/2" Tempered Glass								
Glass Height (in.)	Post Spacing (in.)							
	36.0	42.0	48.0	54.0	60.0	66.0	72.0	78.0
36.0	312.89	229.88	176.00	139.06	112.64	93.09	78.22	66.65
42.0	312.89	229.88	176.00	139.06	112.64	93.09	78.22	66.65
48.0	312.89	229.88	176.00	139.06	112.64	93.09	78.22	66.65
54.0	312.89	229.88	176.00	139.06	112.64	93.09	78.22	66.65
60.0	312.89	229.88	176.00	139.06	112.64	93.09	78.22	66.65

Project Description: Glass Warehouse LLC / FutureGlass – Fabrikasi Posted Glass Railing System	Date: January 30, 2025	Customer: Glass Warehouse LLC / FutureGlass	
	Engineer: SH	Project #: EEV-24-0628	
		PER: 9361	Page #: Page 35 of 39



YOU ENVISION IT – WE ENGINEER IT

1900 NE Miami Ct., Ste. 2-15  
 Miami, FL 33132  
 TEL: 954.399-8478 | FAX: 954.744.4738  
 WEB: [www.buildingdrops.com](http://www.buildingdrops.com)

**Effective Thickness of Laminated Glass: (ASTM E1300 APPENDIX X9)**

**3/16 + 0.06 PVB + 3/16 = 7/16 Laminated Glass**

Glass Ply 1 Nominal Thickness: 3/16 in  
 Glass Ply 2 Nominal Thickness: 3/16 in  
 Interlayer Type: PVB  
 Interlayer Complex Shear Modulus: 70 psi

Laminate Nominal Thickness: 7/16 in  
 Glass Temper: Fully Tempered:

Glass Ply 1 min. Thickness (h1): 0.18 in  
 Glass Ply 2 min. Thickness (h2): 0.18 in  
 Interlayer Thickness (hv): 0.060 in

Laminate Minimum Thickness (hs): 0.240 in  
 Ply 1 weighted Thickness (hs1): 0.120 in  
 Ply 2 weighted Thickness (hs2): 0.120 in

Glass Inertia (Is): 0.0052 in<sup>3</sup>



Glass Dimension (in)	Shear Transfer Coefficient (Γ)	Effective Thickness for Deflection (hef,w)	Effective thickness for Bending (h1;ef,σ)	Effective thickness for Bending (h2;ef,σ)	Section Modulus (in <sup>3</sup> )	Allowable Moment (WL) (in-lb/ft)	Allowable Moment (LL) (in-lb/ft)
36	0.144	0.274	0.310	0.310	0.1923	1846.2	1153.9
42	0.186	0.285	0.322	0.322	0.2071	1987.7	1242.3
48	0.230	0.296	0.332	0.332	0.2210	2121.7	1326.1
54	0.275	0.306	0.342	0.342	0.2339	2245.4	1403.4
60	0.319	0.316	0.350	0.350	0.2456	2357.6	1473.5
66	0.361	0.324	0.358	0.358	0.2561	2458.4	1536.5
72	0.402	0.332	0.364	0.364	0.2654	2548.1	1592.6
78	0.441	0.339	0.370	0.370	0.2737	2627.7	1642.3

**Allowable Stress (Fb<sub>WL</sub>): 9600.00 psi**

**Allowable Stress (Fb<sub>LL</sub>): 6000.00 psi**

Project Description: Glass Warehouse LLC / FutureGlass – Fabrikasi Posted Glass Railing System	Date: January 30, 2025	Customer: Glass Warehouse LLC / FutureGlass	
	Engineer: SH	Project #: EEV-24-0628	
		PER: 9361	Page #: Page 36 of 39



**Effective Thickness of Laminated Glass: (ASTM E1300 APPENDIX X9)**

**3/16 + 0.06 SGP + 3/16 = 7/16 Laminated Glass**

Glass Ply 1 Nominal Thickness: 3/16 in  
 Glass Ply 2 Nominal Thickness: 3/16 in  
 Interlayer Type: SGP  
 Interlayer Complex Shear Modulus: 1638.9 psi

Laminate Nominal Thickness: 7/16 in  
 Glass Temper: Fully Tempered:

Glass Ply 1 min. Thickness (h1): 0.18 in  
 Glass Ply 2 min. Thickness (h2): 0.18 in  
 Interlayer Thickness (hv): 0.060 in

Laminate Minimum Thickness (hs): 0.240 in  
 Ply 1 weighted Thickness (hs1): 0.120 in  
 Ply 2 weighted Thickness (hs2): 0.120 in

Glass Inertia (Is): 0.0052 in<sup>4</sup>



Glass Dimension (in)	Shear Transfer Coefficient (Γ)	Effective Thickness for Deflection (hef,w)	Effective thickness for Bending (h1;ef,σ)	Effective thickness for Bending (h2;ef,σ)	Section Modulus (in <sup>3</sup> )	Allowable Moment (WL) (in-lb/ft)	Allowable Moment (LL) (in-lb/ft)
36	0.798	0.394	0.406	0.406	0.3301	3168.6	1980.4
42	0.843	0.400	0.410	0.410	0.3354	3220.0	2012.5
48	0.875	0.404	0.412	0.412	0.3391	3254.9	2034.3
54	0.899	0.407	0.413	0.413	0.3416	3279.5	2049.7
60	0.916	0.410	0.414	0.414	0.3435	3297.5	2060.9
66	0.930	0.411	0.415	0.415	0.3449	3311.0	2069.4
72	0.940	0.412	0.416	0.416	0.3460	3321.4	2075.9
78	0.949	0.413	0.416	0.416	0.3468	3329.6	2081.0

**Allowable Stress (Fb<sub>WL</sub>): 9600.00 psi**

**Allowable Stress (Fb<sub>ll</sub>): 6000.00 psi**

Project Description: Glass Warehouse LLC / FutureGlass – Fabrikasi Posted Glass Railing System	Date: January 30, 2025	Customer: Glass Warehouse LLC / FutureGlass	
	Engineer: SH	Project #: EEV-24-0628	
		PER: 9361	Page #: Page 37 of 39



YOU ENVISION IT – WE ENGINEER IT

1900 NE Miami Ct., Ste. 2-15  
 Miami, FL 33132  
 TEL: 954.399-8478 | FAX: 954.744.4738  
 WEB: [www.buildingdrops.com](http://www.buildingdrops.com)

**Effective Thickness of Laminated Glass: (ASTM E1300 APPENDIX X9)**

**1/4 + 0.06 PVB + 1/4 = 9/16 Laminated Glass**

Glass Ply 1 Nominal Thickness: 1/4 in  
 Glass Ply 2 Nominal Thickness: 1/4 in  
 Interlayer Type: PVB  
 Interlayer Complex Shear Modulus: 70 psi

Laminate Nominal Thickness: 9/16 in  
 Glass Temper: Fully Tempered:

Glass Ply 1 min. Thickness (h1): 0.219 in  
 Glass Ply 2 min. Thickness (h2): 0.219 in  
 Interlayer Thickness (hv): 0.060 in

Laminate Minimum Thickness (hs): 0.279 in  
 Ply 1 weighted Thickness (hs1): 0.140 in  
 Ply 2 weighted Thickness (hs2): 0.140 in

Glass Inertia (Is): 0.0085 in<sup>3</sup>

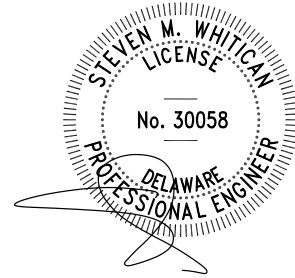

Glass Dimension (in)	Shear Transfer Coefficient (Γ)	Effective Thickness for Deflection (h <sub>ef,w</sub> )	Effective thickness for Bending (h1;ef,σ)	Effective thickness for Bending (h2;ef,σ)	Section Modulus (in <sup>3</sup> )	Allowable Moment (WL) (in-lb/ft)	Allowable Moment (LL) (in-lb/ft)
36	0.121	0.322	0.364	0.364	0.2645	2539.2	1587.0
42	0.158	0.334	0.376	0.376	0.2829	2715.4	1697.1
48	0.197	0.345	0.388	0.388	0.3007	2886.8	1804.2
54	0.237	0.356	0.399	0.399	0.3176	3049.2	1905.8
60	0.278	0.367	0.408	0.408	0.3334	3200.3	2000.2
66	0.317	0.377	0.417	0.417	0.3478	3338.9	2086.8
72	0.356	0.386	0.425	0.425	0.3609	3464.9	2165.5
78	0.394	0.394	0.432	0.432	0.3728	3578.6	2236.6

**Allowable Stress (F<sub>bWL</sub>): 9600.00 psi**

**Allowable Stress (F<sub>bLL</sub>): 6000.00 psi**

Project Description: Glass Warehouse LLC / FutureGlass – Fabrikasi Posted Glass Railing System	Date: January 30, 2025	Customer: Glass Warehouse LLC / FutureGlass	
	Engineer: SH	Project #: EEV-24-0628	
		PER: 9361	Page #: Page 38 of 39



YOU ENVISION IT – WE ENGINEER IT

1900 NE Miami Ct., Ste. 2-15  
 Miami, FL 33132  
 TEL: 954.399-8478 | FAX: 954.744.4738  
 WEB: [www.buildingdrops.com](http://www.buildingdrops.com)

**Effective Thickness of Laminated Glass: (ASTM E1300 APPENDIX X9)**

**1/4 + 0.06 SGP + 1/4 = 9/16 Laminated Glass**

Glass Ply 1 Nominal Thickness: 1/4 in  
 Glass Ply 2 Nominal Thickness: 1/4 in  
 Interlayer Type: SGP  
 Interlayer Complex Shear Modulus: 1638.9 psi

Laminate Nominal Thickness: 9/16 in  
 Glass Temper: Fully Tempered:

Glass Ply 1 min. Thickness (h1): 0.219 in  
 Glass Ply 2 min. Thickness (h2): 0.219 in  
 Interlayer Thickness (hv): 0.060 in

Laminate Minimum Thickness (hs): 0.279 in  
 Ply 1 weighted Thickness (hs1): 0.140 in  
 Ply 2 weighted Thickness (hs2): 0.140 in

Glass Inertia (Is): 0.0085 in<sup>3</sup>

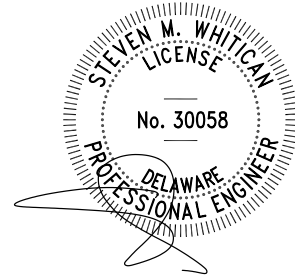

Glass Dimension (in)	Shear Transfer Coefficient (Γ)	Effective Thickness for Deflection (hef,w)	Effective thickness for Bending (h1;ef,σ)	Effective thickness for Bending (h2;ef,σ)	Section Modulus (in <sup>3</sup> )	Allowable Moment (WL) (in-lb/ft)	Allowable Moment (LL) (in-lb/ft)
36	0.764	0.463	0.479	0.479	0.4590	4406.2	2753.9
42	0.815	0.471	0.484	0.484	0.4677	4490.2	2806.4
48	0.852	0.476	0.487	0.487	0.4737	4547.7	2842.3
54	0.879	0.481	0.489	0.489	0.4780	4588.6	2867.9
60	0.900	0.484	0.490	0.490	0.4811	4618.6	2886.6
66	0.916	0.486	0.492	0.492	0.4835	4641.3	2900.8
72	0.928	0.488	0.493	0.493	0.4853	4658.7	2911.7
78	0.938	0.489	0.493	0.493	0.4867	4672.5	2920.3

**Allowable Stress (Fb<sub>WL</sub>): 9600.00 psi**

**Allowable Stress (Fb<sub>LL</sub>): 6000.00 psi**

Project Description: Glass Warehouse LLC / FutureGlass – Fabrikasi Posted Glass Railing System	Date: January 30, 2025	Customer: Glass Warehouse LLC / FutureGlass	
	Engineer: SH	Project #: EEV-24-0628	
	PER: 9361	Page #: Page 39 of 39	