

Thank you for choosing Sunnydaze Decor. We stand behind our brand and the quality of the items we sell. Replacement parts or products will be sent at our discretion within the 1-year warranty period. Proof of purchase, with the date of purchase as well as photos of the merchandise defect, must be provided. Photos are used to determine the cause of defects and for future quality control. Register your warranty at <https://tiny.cc/SunnydazeWarranty>. If you have any questions, comments or concerns, feel free to contact us by phone at 833-982-1977, by email: [customerservice@sunnydazedecor.com](mailto:customerservice@sunnydazedecor.com), or via our contact us page at <https://tiny.cc/SunnydazeContact>

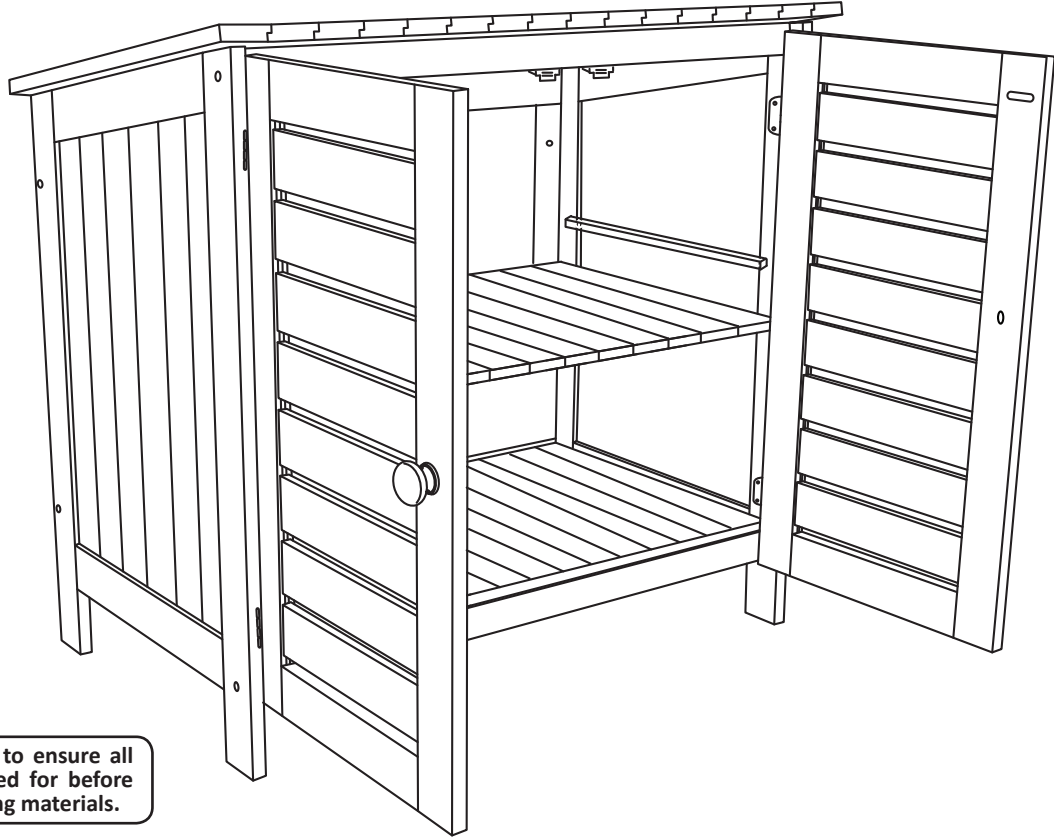



# MERANTI WOOD GARDEN STORAGE SHED





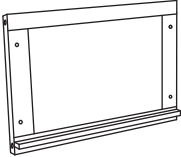
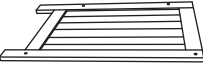

## FRN-732

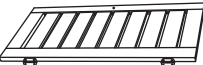
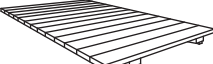
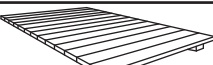
Assemble components on a soft, clean surface to avoid damaging the finish. Save this manual for future reference.

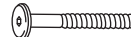
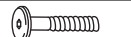

Inspect packaging to ensure all parts are accounted for before disposing of packing materials.

No.	PARTS	QTY.
A	 Back Panel	1
B	 Side Panel (L/R)	2
C	 Top Support	1
D	 Bottom Support	1
E	 Roof	1
F	 Door Panel (L/R)	2
G	 Top Shelf	1
H	 Bottom Shelf	1

No.	HARDWARE	QTY.
I	 JCBC M6x60mm Bolt	8
J	 JCBC M6x35mm Bolt	4
K	 M3.5x16mm Screw	8
L	 M4x30mm Bolt	2
M	 Knob	2
N	 Barrel Nut	8
O	 Hex Key w/ Phillips End	1
P	 Barrel Nut Driver	1

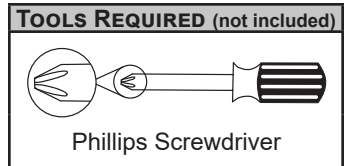

**! WARNING !**

**CHOKING HAZARD** — This item contains small parts that can be swallowed. Keep children and pets away during assembly.

# ASSEMBLY

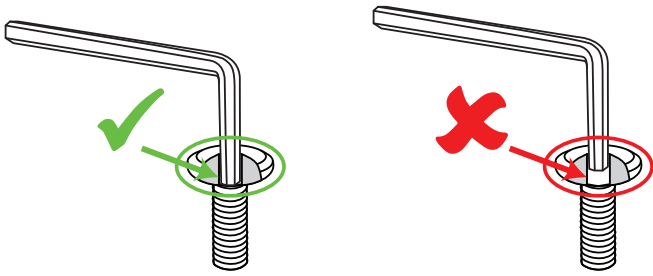

**TIP:** Always fully insert the hex key inside the designated notch of the bolt.

If the hex key is not fully inside the notch, the hex key could slip out, causing damage to the bolt head. Repeated hex key slipping will cause the notch to become rounded, making it difficult or impossible to tighten the bolt with the hex key.

**Follow drawings closely and understand assembly before beginning.**

## STEP 1

A: 1  
B: 1  
C: 1  
D: 1  
I: 4  
N: 4

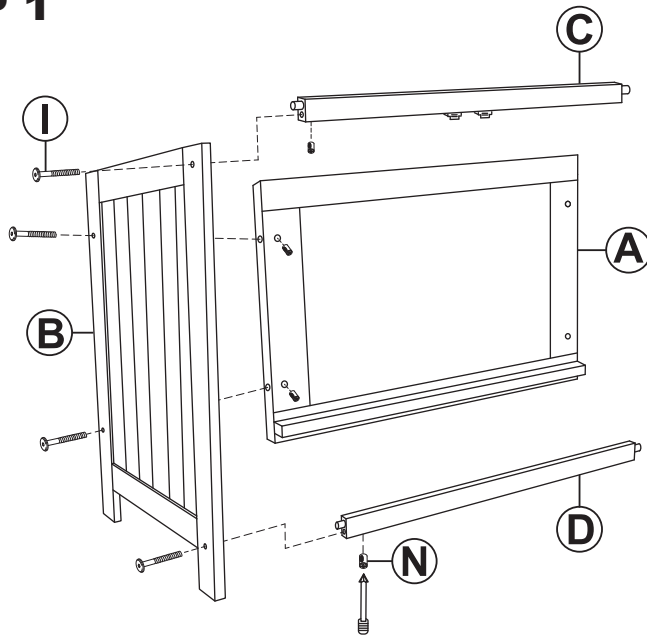

- Lay Back Panel (A) on a flat, clean surface.
- Insert two Barrel Nuts (N) into the left side of Back Panel (A). Use the Barrel Nut Driver to align the opening of the barrel nut with the openings on the side of the back panel.
- Align the backside of the left Side Panel (B) with Back Panel (A). Then, loosely fasten them by threading two JCBC M6x60mm Bolts (I) into the barrel nuts.
- Ensuring the magnets are facing forward, insert Top Support (C) into the top of Side Panel (B).
- Insert a Barrel Nut (N) into the bottom of the top support. Then loosely fasten the support to the side panel by threading one JCBC M6x60mm Bolts (I) into the barrel nut.
- Secure Bottom Support (D) to the bottom of the side panel using one Barrel Nut (N) and one JCBC M6x60mm Bolt (I), as shown.

## STEP 2

B: 1  
I: 4  
N: 4

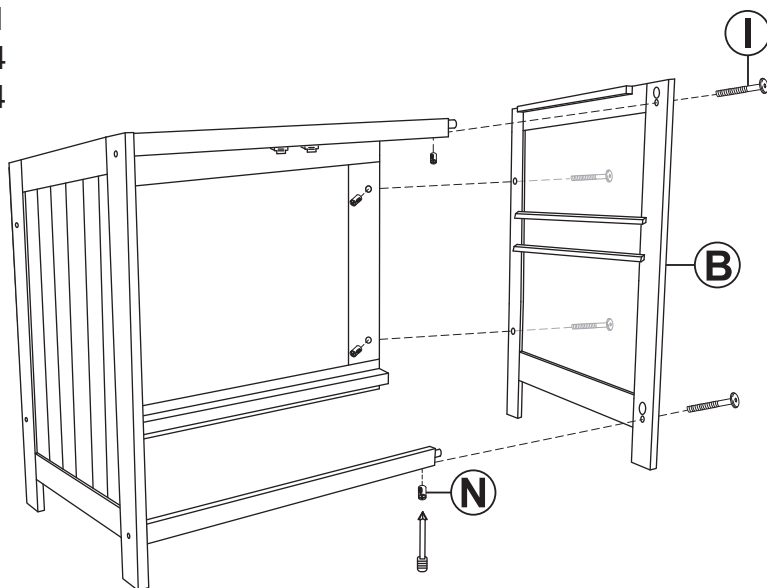

- Align the right side Side Panel (B) with Back Panel (A), Top Support (C), and Bottom Support (D).
- Insert two Barrel Nuts (N) into the right side of the back panel. Use the Barrel Nut Driver to align the opening of the barrel nut with the openings on the right side.
- Secure the side panel to the back panel by threading two JCBC M6x60mm Bolts (I) into the barrel nuts.
- Insert a Barrel Nut (N) into the bottom of the top support. Then loosely fasten the support to the side panel by threading one JCBC M6x60mm Bolts (I) into the barrel nut.
- Secure Bottom Support (D) to the bottom of the side panel using one Barrel Nut (N) and one JCBC M6x60mm Bolt (I), as shown.

### STEP 3

E: 1  
G: 1  
H: 1  
J: 4

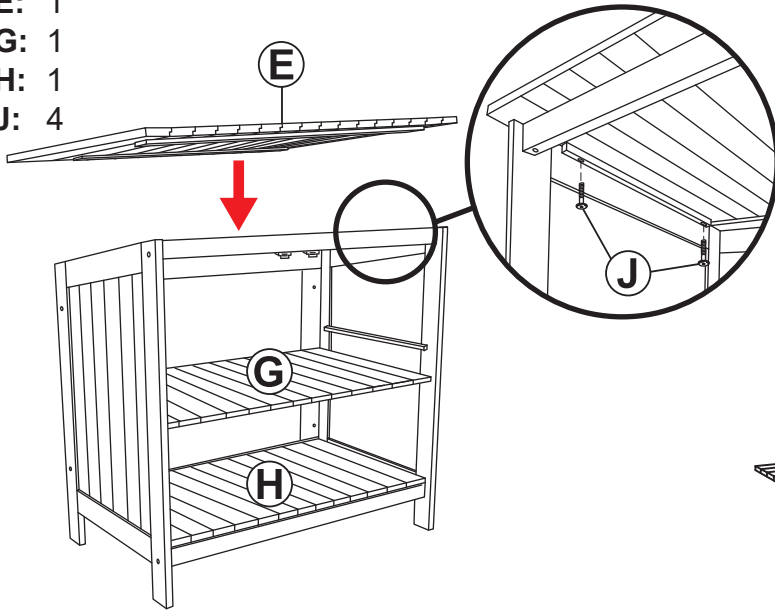

**TIP:** Assistance may be required for aligning the mounting holes in the roof with the mounting holes in the side panels.

- Place Roof (E) on the assembled frame.
- Use four JCBC M6x35mm Bolts (J) to secure the side panels to the roof, as shown.
- Place Bottom Shelf (H) in the bottom of the storage box.
- Place Top Shelf (G) on the cleats (shelf supports) that are pre-installed on the side panels.

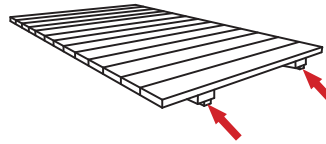

**NOTE:** Top Shelf (G) has additional support beams on the bottom for increased weight capacity.

### STEP 4

F: 2  
L: 2  
M: 2

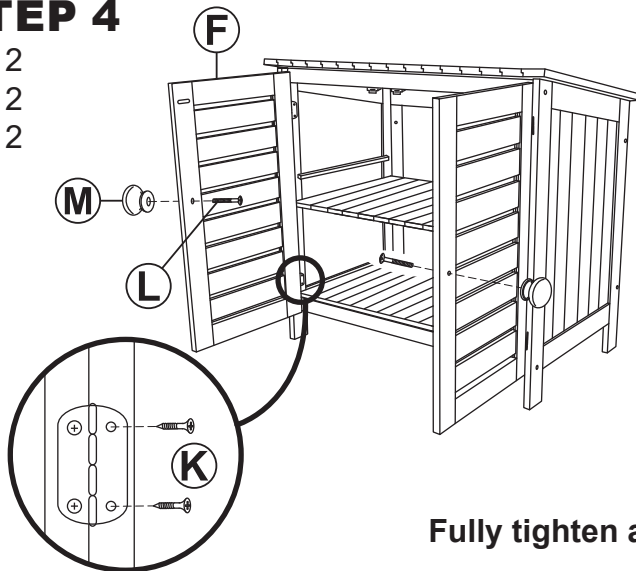

- Identify the left and right Door Panel (F).
- Secure the left Door Panel (F) to the left side of the storage box using two M3.5x16mm Screws (K).
- Secure the right Door Panel (F) to the right side of the storage box using two M3.5x16mm Screws (K).
- Secure one Knob (M) to each door using a M4x30mm Bolt (L).

**Fully tighten all hardware from all steps after this step is complete.**

## Care & Maintenance

**SAFE USE:** Only use on a flat, level surface. Do not exceed the weight capacity of the shelves. Do not stand or climb on any part of this unit.

**GENERAL USE:** This unit is not waterproof. Do not store items that could become damaged by water. Do not store items that could damage the unit.

**INSPECT:** Periodically check assembly points and tighten fittings as necessary.

**CLEANING:** Identify the direction of the woodgrain. Following the direction of the woodgrain, wipe surfaces with a soft, dry cloth. Do not use harsh chemicals or abrasive materials or a pressure washer to clean.

**WINTER CARE & STORAGE:** Protect this item from inclement weather, especially ice and snow. Move to a cool, dry indoor location.

Covering while in storage is recommended to help prevent dust build-up.

**MAINTENANCE:** If left untreated, the wood may weather. To maintain the appearance, apply a suitable penetrating Wood, Teak or Linseed Oil (not included) yearly, or when the wood looks particularly dry.

Clean the unit and bring it into a dry, warm, indoor location. Allow the unit to thoroughly dry before applying oil; drying may take several days. Only apply oil to wooden surfaces. Apply oil as directed by the wood oil manufacturer.

**WARNING: THE ONE-YEAR WARRANTY DOES NOT COVER DAMAGES OR DEFECTS CAUSED BY THE USE OF CHEMICAL TREATMENTS OR PROTECTIVE COATINGS.**

## SAFETY STATEMENTS & WARNINGS

- Do not exceed the weight capacity of each shelf.
- Do not allow children to play in or around this unit.
- Firmly secure all hardware before use.
- Inspect hardware often and tighten as necessary.
- Do not use this item in the proximity of open flame or flammable/combustible chemicals.
- Keep this unit a safe distance from heat sources such as fire pits, patio heaters, and grills.
- Do not store flammable or combustible items inside this unit.
- Do not use harsh chemicals or abrasive materials to clean this unit.
- This product is for residential use only; institutional or commercial use will void this warranty.

**Any modification to the product or failure to follow recommended care will void the product warranty.**

## WARNING

**Manufacturer and seller expressly disclaim any and all liability from personal injury, property damage or loss, whether direct or indirect, or incidental, resulting from the incorrect attachment, improper use, inadequate maintenance, or neglect of this product.**