



---

**Extended Warranty  
Sign Up**

---

**E-1**

# Welcome home!

**ELG-587/597**

**TEAMSON HOME  
Corner Wall Cabinet  
-Shutter Doors**

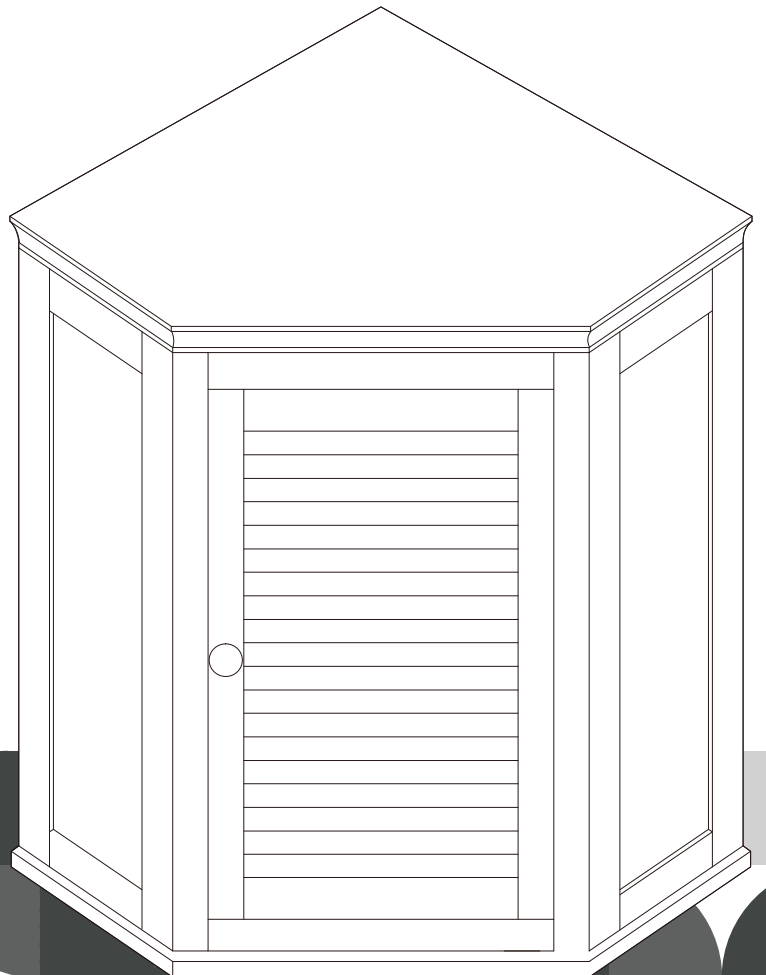



**Questions? Comments? Need help?  
Call or email us any time!**

## Global Customer Service

**USA**

**+1(800)935-3959**

Mon - Fri 10:00am ~ 2:00pm EST

✉ [support@teamson.com](mailto:support@teamson.com)

**EU/UK**

**+44(0)1952-916-050**

Mon - Thu 9:00am ~ 5:00pm GMT

Friday 9:00am ~ 4:00pm GMT

✉ [support@teamson.co.uk](mailto:support@teamson.co.uk)

**ASIA**

深圳办公室:

**+86(0755)8885-3558.分机号331**

Mon - Sat 9:00am ~ 5:00pm GMT+8

✉ [sales\\_ec@teamson.com](mailto:sales_ec@teamson.com)

台北办公室:

**+886(2)2556-6268**

Mon - Fri 9:00am ~ 5:00pm GMT+8

✉ [sales\\_ec@teamson.com](mailto:sales_ec@teamson.com)

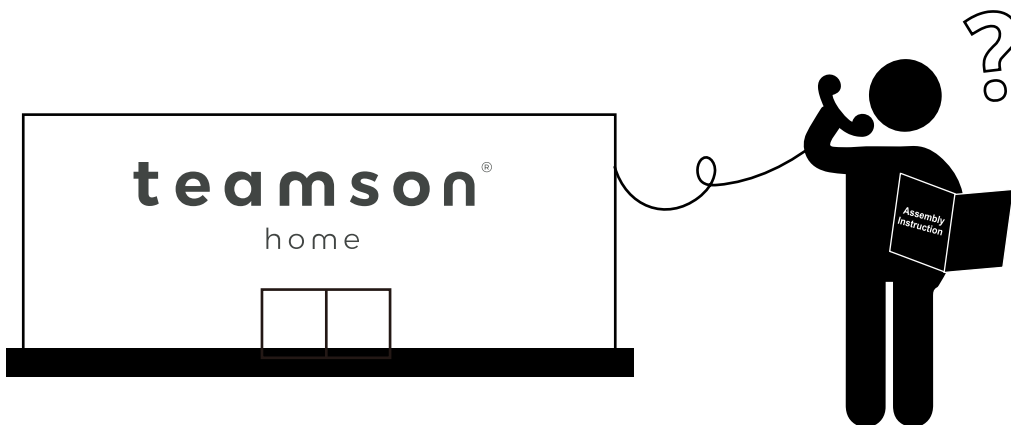
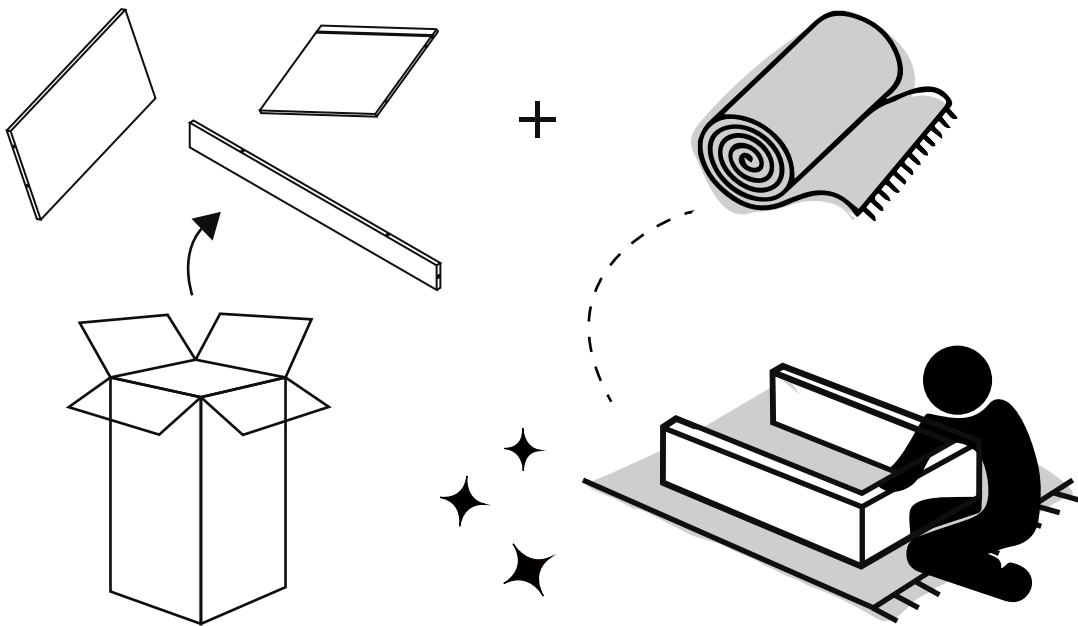
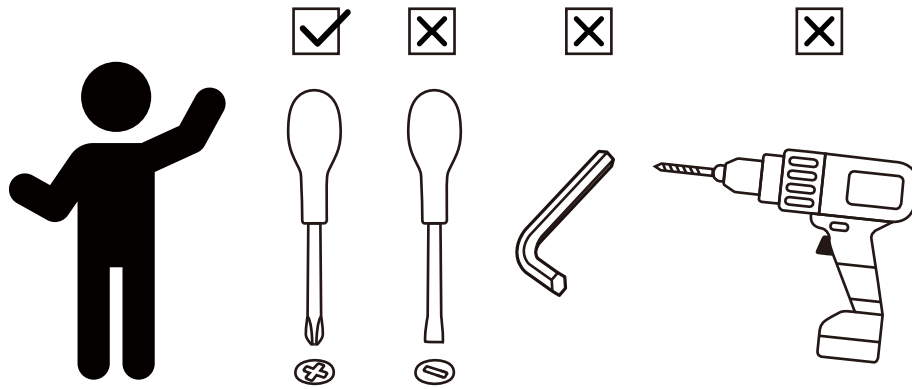

\*\* Got questions? Please have your product code (on the first page of this instruction, e.g. TD-12345A) and the order number ready, give us a call or email us through our customer care support! We are always ready to assist you!

# Exploded Drawing

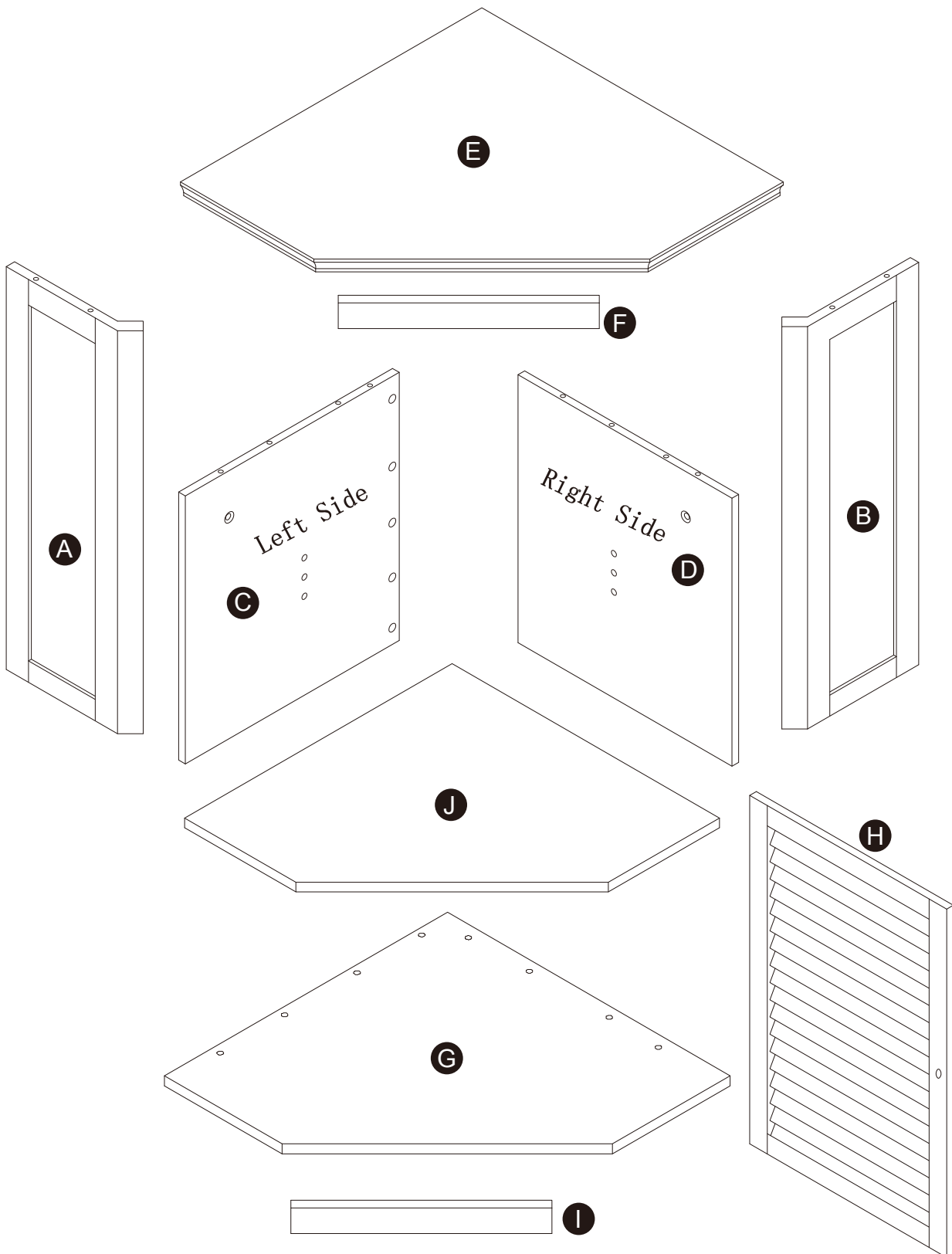

Scan for assembly instructions.

## Product Parts

A



1 PC

B

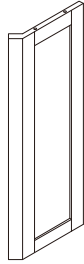

1 PC

C

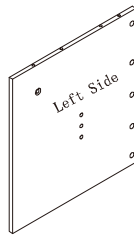

1 PC

D

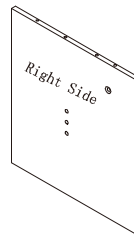

1 PC

E

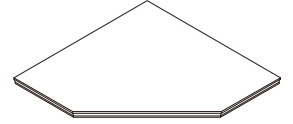

1 PC

F

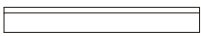

1 PC

G

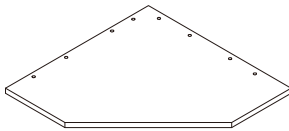

1 PC

H

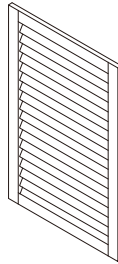

1 PC

I

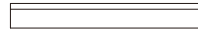

1 PC

J

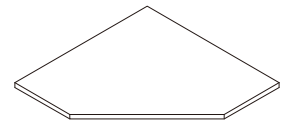

1 PC

### **! Care Instructions**

Dust surface with a dry soft cloth. Do not use window cleaners or cleaning abrasives as they will scratch the surface and could damage the protective coating

### **! WARNING**

Small parts and sharp edges may be present prior to assembly.



Scan for assembly instructions.

# Hardware

1

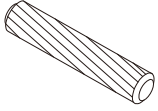

Ø8\*30mm

25 PCS

2

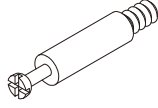

16 PCS

3

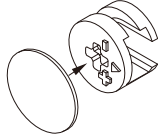

Ø15\*12

12 PCS

4

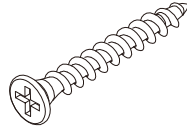

Ø4\*25mm

3 PCS

5

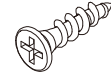

Ø3\*12mm

4 PCS

6

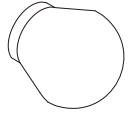

1 PC

7



1 PC

8

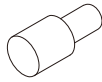

4 PCS

9

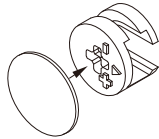

Ø15\*9

4 PCS

10

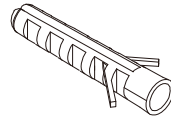

2 PCS

11

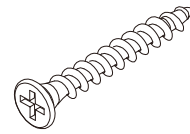

Ø4\*35mm

2 PCS

## TEMPLATE PAPER

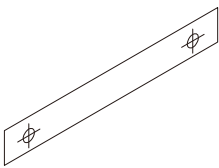

Scan for assembly instructions.

# Step 1

- 1  9 pcs  $\varnothing 8 \times 30 \text{mm}$
- 2  4 pcs
- 3   $\varnothing 15 \times 12$  2 pcs
- 4   $\varnothing 4 \times 25 \text{mm}$  2 pcs

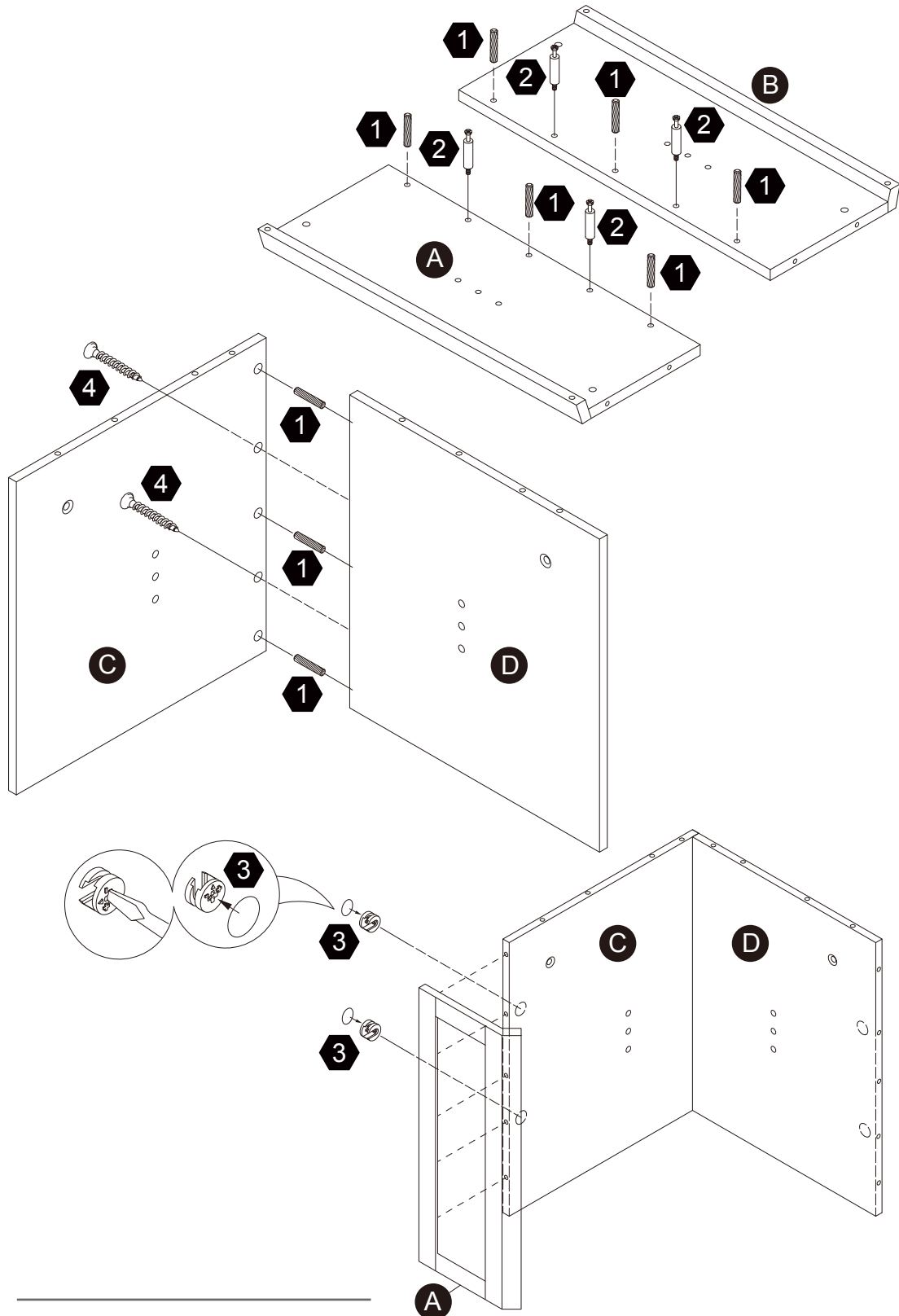

Scan for assembly instructions.

## Step 2

**1**   $\varnothing 8 \times 30 \text{mm}$  4 pcs **3**   $\varnothing 15 \times 12$  2 pcs

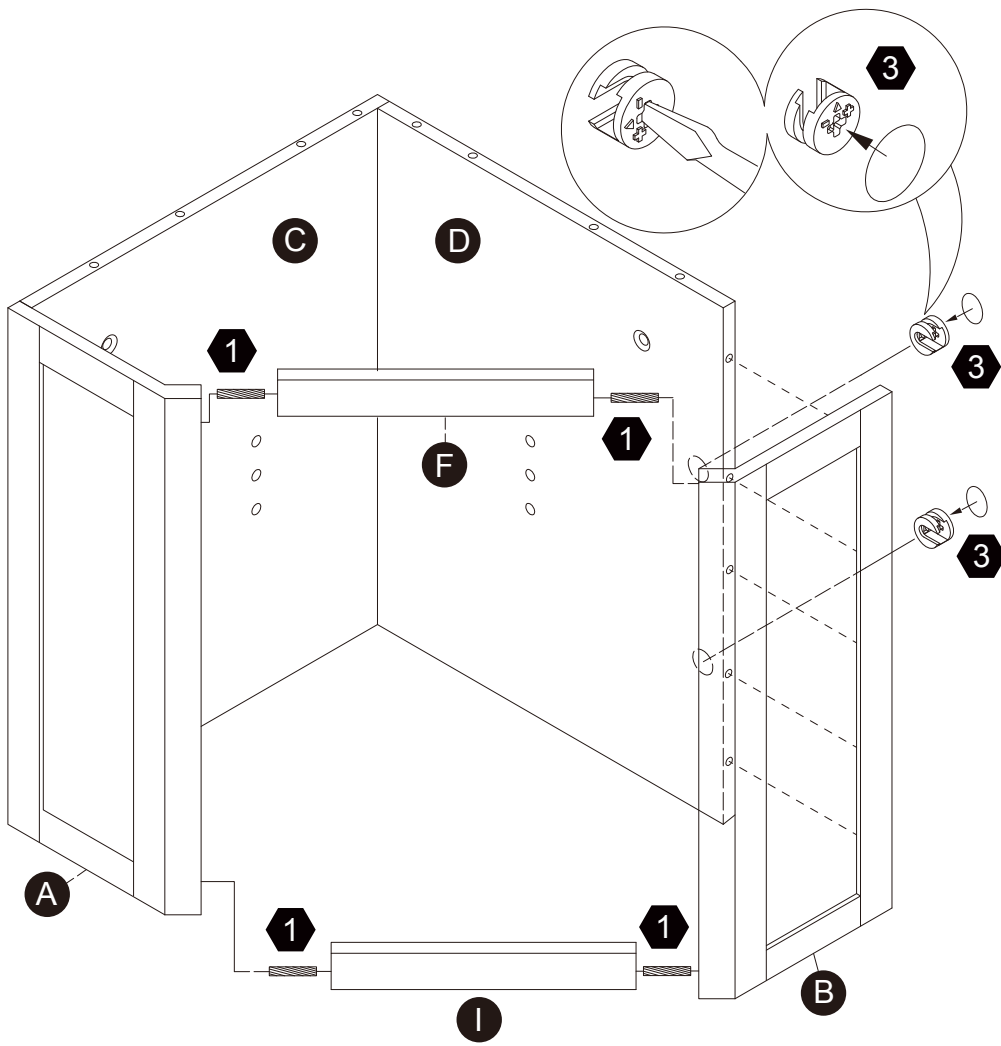

Scan for assembly instructions.



### Step 3

1  $\varnothing 8 \times 30 \text{mm}$  6 pcs

2  $\varnothing 8 \times 30 \text{mm}$  6 pcs



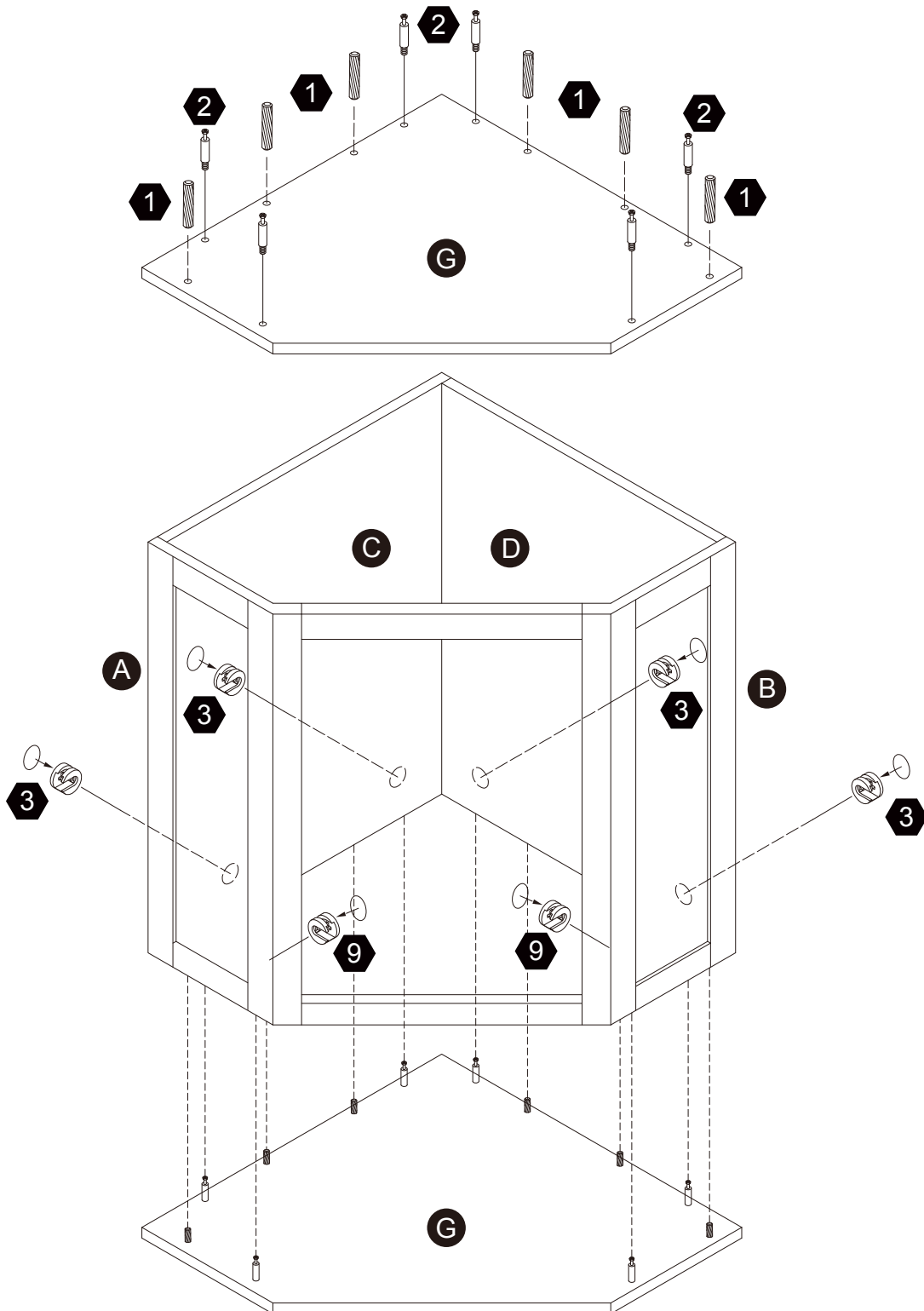

3  $\varnothing 15 \times 12$  4 pcs

9  $\varnothing 15 \times 9$  2 pcs

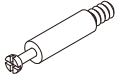

Scan for assembly instructions.

## Step 4

- 1  6 pcs  $\text{Ø}8*30\text{mm}$
- 2  6 pcs
- 3  4 pcs  $\text{Ø}15*12$
- 4  1 pc  $\text{Ø}4*25\text{mm}$
- 9  2 pcs  $\text{Ø}15*9$

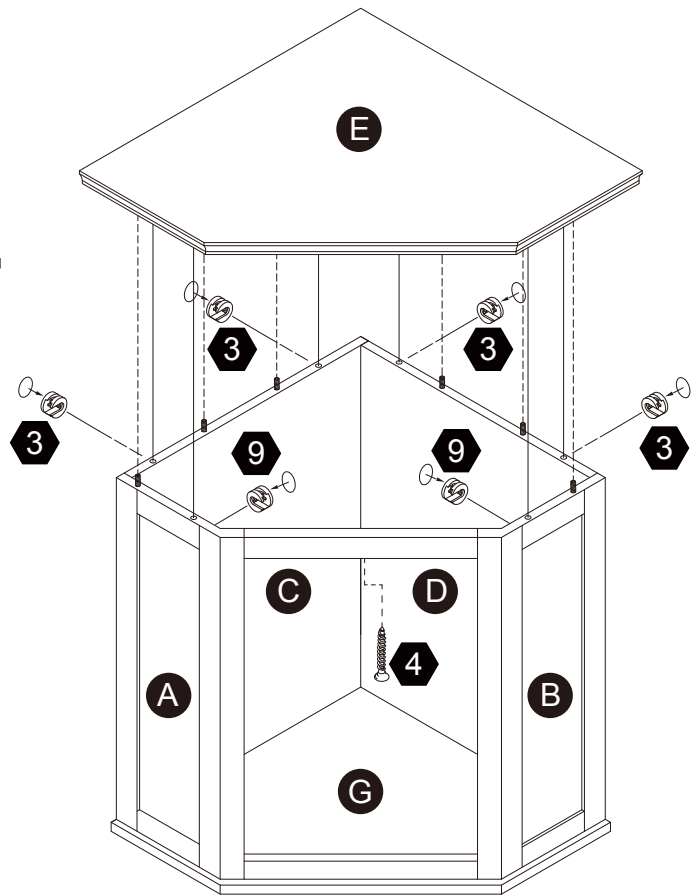
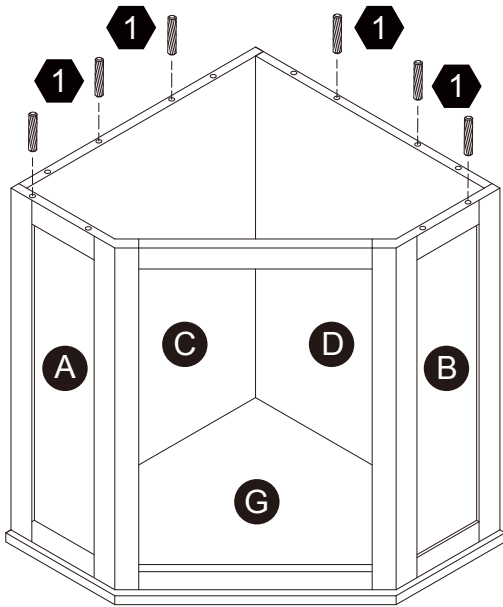
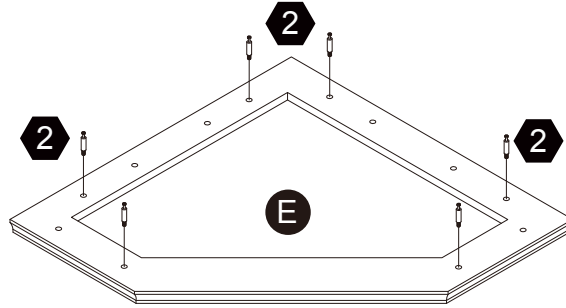

Scan for assembly instructions.

# Step 5

- 5  4 pcs  $\varnothing 3 \times 12 \text{mm}$
- 6  1 pc
- 7  1 pc
- 8  4 pcs

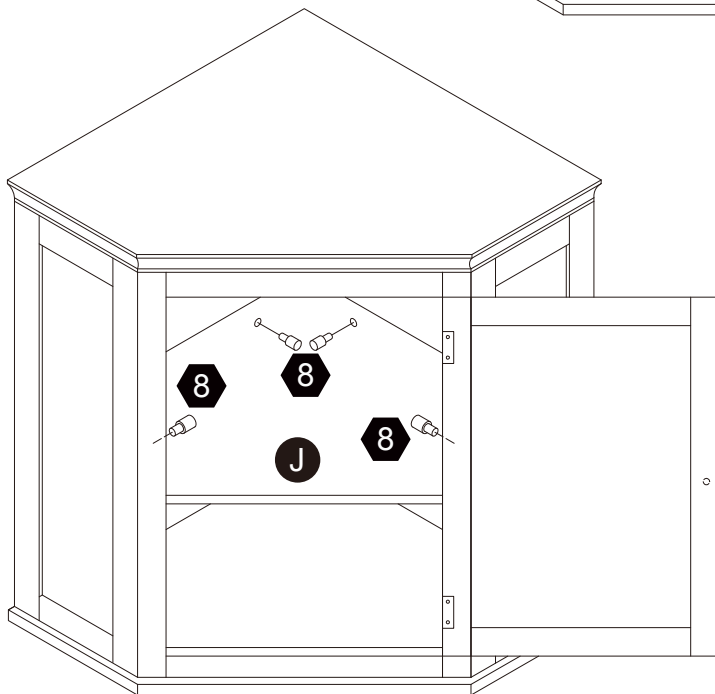
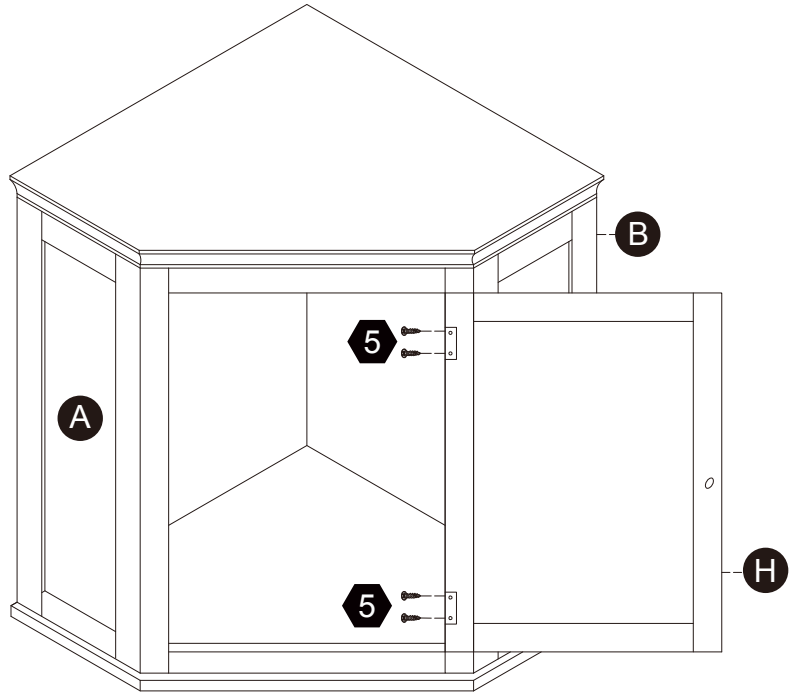
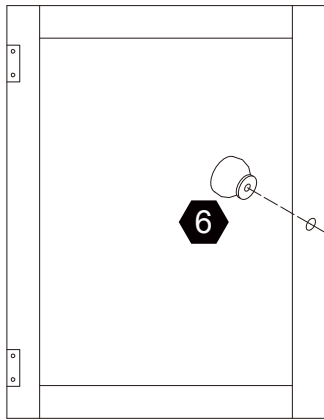

Scan for assembly instructions.

## Step 6

10

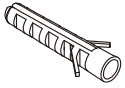

2 pcs

11



2 pcs

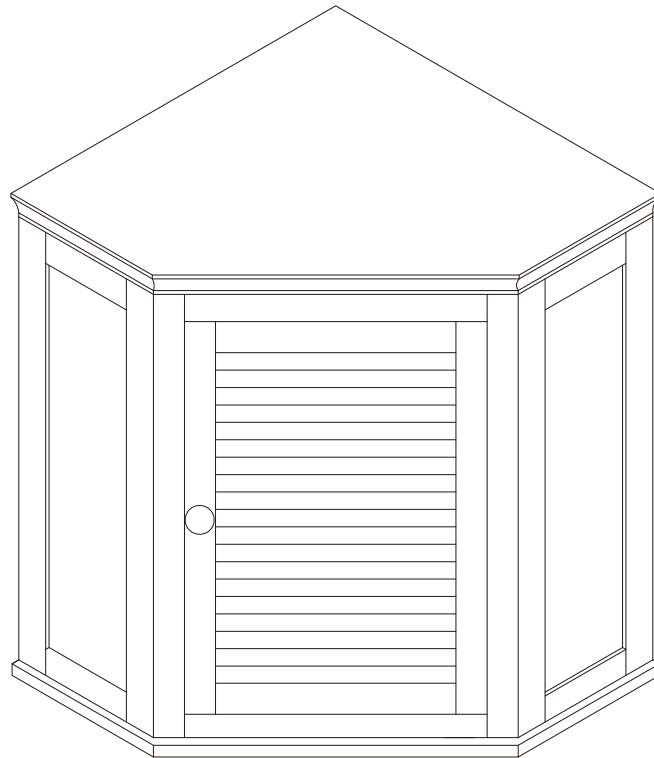
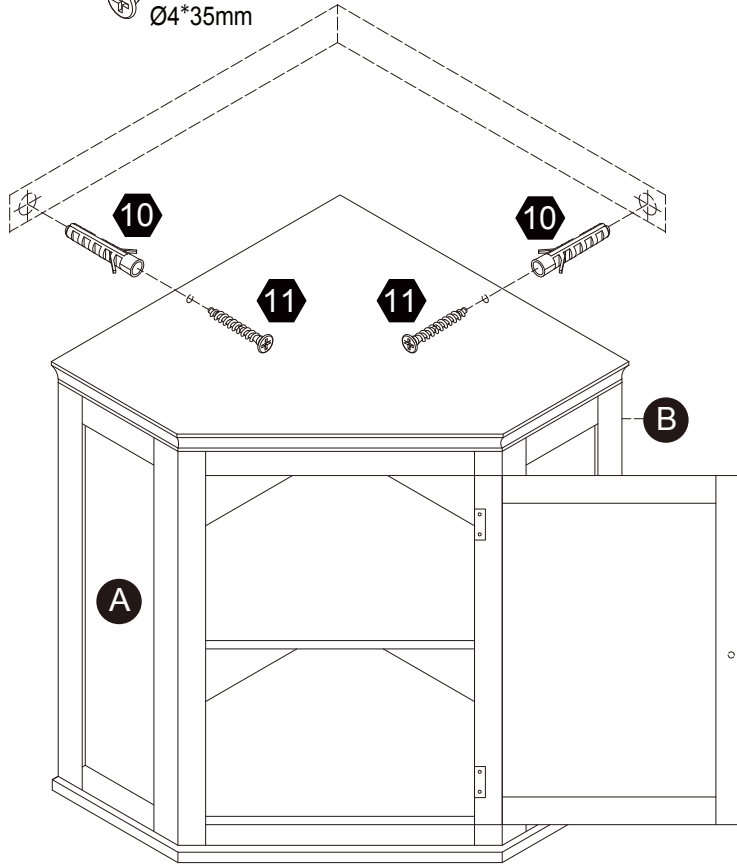

Scan for assembly instructions.