

FLEXSTEEL®

Power Reclining Loveseat with Power Headrests

IMPORTANT NOTE

Read these instructions carefully, and familiarize yourself with each procedure before assembling the furniture. Check that you have all the component parts, and familiarize yourself with each part before proceeding.

Take all the fittings out of the plastic bag and separate them into groups. Ensure you have enough space to lay out all the parts before assembly. To prevent damage to the parts, we recommend that you assemble the unit on a soft, level surface.

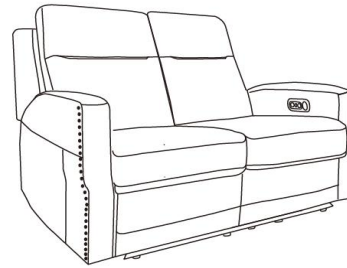

Part List

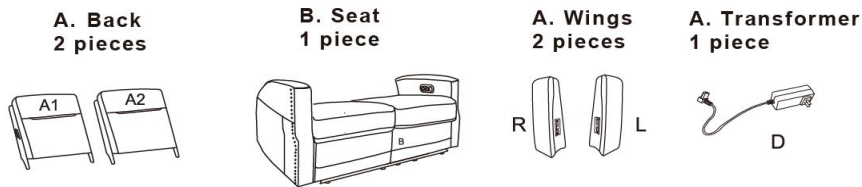

Assembly Instructions

STEP 1

Take out the Transformer (D) and WINGS(L/R) from the bottom of the seat . (See Figure 1)

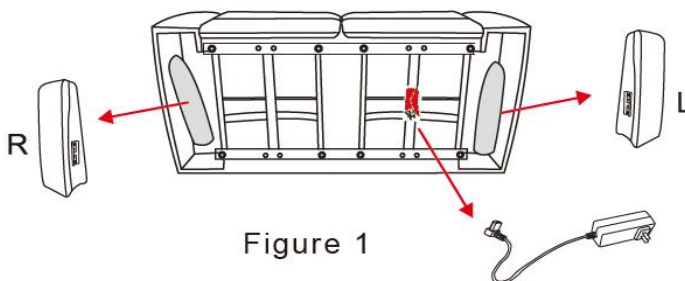

Figure 1

STEP 2

Attach Left Back (A1), and Right Back (A2) to Seat (B), ensure the brackets fit tightly. Insert Left Wing and Right Wing to Left and Right Back (B). Ensure the Wings are fixed securely. (See Figure 2)

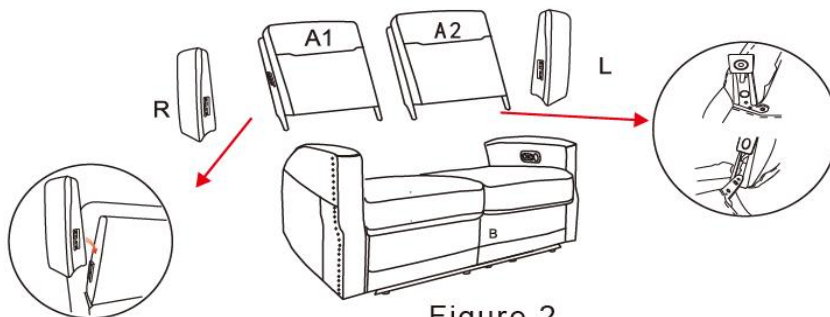

Figure 2

STEP 3

Zip the black fabric on bottom of Back (A) with back of Seat (B). (See Figure 3).

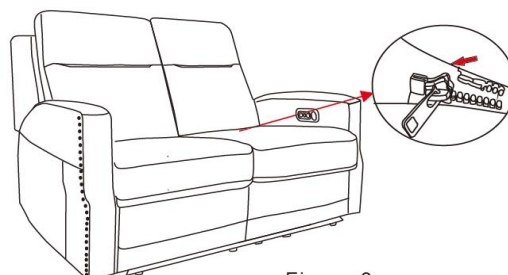

Figure 3

STEP 4

Flip up the back flap, and remove the headrest cable from the Back (A). Connect the headrest cable to the power button control cable, place the lumbar cable (yellow label) to the power button control cable (yellow label). (See Figure 4)

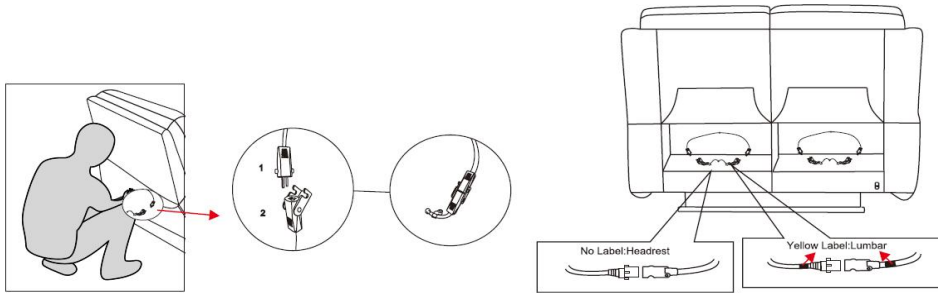

Figure 4

STEP 5

Connect the transformer (D) into the power port on the back of the piece, then plug it into a nearby outlet, still making sure it is clear of the metal base. (See Figure 5). Then fasten the back flaps to the bottom of the furniture. (See Figure 6)

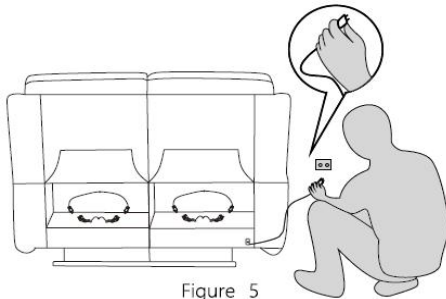

Figure 5

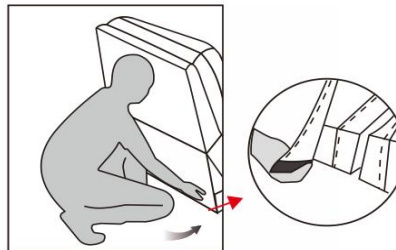

Figure 6

Disassemble Back (A)

Pull up the spring leaf in bracket, then lift Back (A) up. Unzip the black fabric on bottom of back from back of seat. (See figure 7)

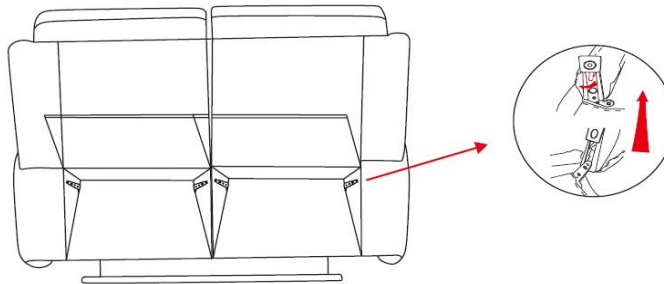

Figure 7

IMPORTANT NOTE

- To avoid any risk of suffocation to children or pets, dispose of all plastic bags immediately.
- To ensure proper performance, occasionally check for loose screws and tighten as needed.
- If the reclining functions are not working properly, check for loose cable connections before contacting the retailer.