

MAINTENANCE

It may be necessary to periodically wipe down the heater and reflector, depending on the placement and the amount of use.

How to clean the reflector:

1. Disconnect the power cord from the outlet. Be sure heater has completely cooled.
2. Remove the safety bars by pressing down on the top edge and gently pulling forward until it releases.
3. Wipe the reflector with a dry soft cloth or one treated with detergent.

LIMITED WARRANTY

PERFORMANCE TOOL® extends only the following warranties, and only to original retail purchasers. These warranties give specific legal rights. Except where prohibited by local law, the law of the State of Washington governs all warranties and all exclusions and limitations of warranties and remedies. There may be other rights which vary from state to state.

PERFORMANCE TOOL® warrants the product to be free from defects in materials and workmanship under normal use and service. A defective product may be returned for a free replacement within 90 days from the date of purchase, provided that product is returned to place of purchase immediately after discovery of defect. After 90 days and up to one year from date of purchase, PERFORMANCE TOOL® will replace at no charge any parts which our examination shall disclose to be defective and under warranty. These warranties shall be valid only when a sales receipt showing the date of purchase accompanies the defective product or defective part (s) being returned. For part (s) after 90 days, please remit your request, postage prepaid to:

PERFORMANCE TOOL, P.O. Box 88259 Tukwila, WA 98138

These warranties exclude blades, bits, punches, dies, bulbs, fuses, hoses, and other consumables which must be replaced under normal use and service. These warranties shall not apply to any product or part which is used for a purpose for which it is not designed, or which has been repaired or altered in any way so as to affect adversely its performance or reliability, nor shall these warranties apply to any product or part which has been subject to misuse, neglect, accident or wear and tear incident to normal use and service.

PERFORMANCE TOOL® does not authorize any other person to make any warranty or to assume any liability in connection with its products.

Except for warranties of title and the limited express warranties set forth above, PERFORMANCE TOOL® makes no express or implied warranties of any kind with respect to its products. In particular, PERFORMANCE TOOL® makes no implied warranty of merchantability and no implied warranty of fitness for any particular purpose, except that for goods purchased primarily for personal, family or household use and not for commercial or business use, PERFORMANCE TOOL® makes an implied warranty of merchantability (and, if otherwise applicable, an implied warranty of fitness for a particular purpose), but only for the particular qualities or characteristics, and for the duration, expressly warranted above.

The laws on limitation of implied warranties may differ from state to state, so the above limitations may not apply in all cases.

PERFORMANCE TOOL® shall not be liable for consequential, incidental or special damages resulting from or in any manner related to any product, or to the design, use, or any inability to use the product. The sole and exclusive remedy for a defective product or part shall be the repair, or replacement thereof as provided above. The laws on limitation of remedies or on consequential, incidental or special damages may vary from state to state, so the above limitations may not apply in all cases.

© Copyright 2018 WILMAR CORPORATION, P.O. Box 88259 Tukwila, WA 98138

1500W INFRARED SHOP HEATER

Item Number W5008

OWNER'S MANUAL

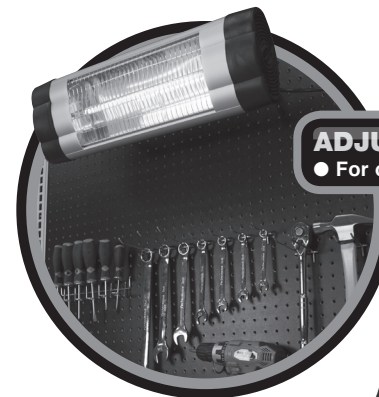

ADJUSTABLE THERMOSTAT
● For optimum comfort & auto shut-off



MOUNT TO THE WALL OR CEILING
● With included adjustable hanging brackets

PT
Performance Tool®

Please read these instructions carefully and retain them for future use.

On occasion, after printing of our literature is completed, our manufacturers may make changes and/or modifications to merchandise which will not be reflected in this manual. Although we strive to maintain complete and accurate information, it is possible in some instances, that the product may differ slightly from printed specifications. Illustrations are intended for reference only. Actual merchandise may vary. Wilmar is not responsible for typographical errors.

Performance Tool®

PRODUCT FEATURES

1. Adjustable Thermostat
2. Heating Element
3. Protective Covers
4. Safety Bars
5. Mounting Brackets
6. 8 ft. Grounded Cord



SPECIFICATIONS

Voltage:	120v
Frequency:	60Hz
Power:	1500W
Size:	23.8 x 7.4 x 3.5 in.
Weight:	4.0 lb.

Specifications are subject to change without notice

IMPORTANT SAFETY INFORMATION

Read these safety warnings before operation.

WARNING!

- Read the instructions carefully before use and save the manual for future reference.
- Remove the packaging and make sure that the heater is intact. Do not leave the packaging materials, like bags and staples, within the reach of children.
- Always disconnect the heater from the main supply when not in use and when cleaning.
- Do not leave the heater "ON" unattended.
- To avoid overheating, do not cover the heater or place any object on or in front of the safety bar.
- Keep the heater a distance of at least 1 yard from any combustible material, such as furniture, curtains, bedding, clothes or papers.
- Keep the heater clean. Do not place any objects near or inside the safety bars or heating element, as this may cause electric shock, fire, or damage to the heater.
- Never allow the power cord to touch wet or hot surfaces, become twisted, or be within reach of children.
- If the power cord is damaged, stop use immediately to avoid danger, and the damaged part must be replaced by the factory or other similar professional.
- Do not place on or near a hot gas or electric burner.
- Never touch the heater with wet or damp hands or feet.
- Never expose the heater to atmospheric conditions (rain, direct sunlight, snow, etc).
- Do not use the heater for anything other than its intended use. This heater is intended for household use only.
- Do not use the heater in the immediate surroundings of water such as a bath, shower or swimming pool.
- Do not put the power cord on the heater while it is still warm.
- Do not connect the heater to extension cords or multiple outlets.
- The safety bars of this heater are intended to prevent direct access to heating element and must be in place when the appliance is in use.
- This heater is not equipped with a device to control the room temperature. Do not use this heater in small rooms when they are occupied by persons not capable of leaving on their own, unless constant supervision is provided.
- Close supervision is required when heater is used near or by children.

IMPORTANT SAFETY INFORMATION

- This heater is not intended for use by anyone (including children) with reduced physical, sensory, or mental capabilities, or lack of experience and knowledge, unless they have been given supervision or instruction concerning use of the heater by a person responsible for their safety.
- The heater must not be installed immediately below a socket outlet.
- Except for when mounting at a high level, do not use the heater with a programmer, timer or any other device that switches the heater on automatically.
- Before moving the heater, be sure that the power supply is turned off.

INSTALLATION ON THE WALL OR CEILING

There are four brackets and fasteners to use with the heater. There are also 4 square fastener washers (0.98 in.) in the slot on the back side of the heater.

STEP 1:

Position the square bolts inside the slot (Figure 1) with 2 of the brackets as shown in Figure 2. Be sure the distance between the brackets matches the distance they will be spaced on the wall. Fasten using 4 short screws. A minimum of 16 inches is suggested.

Figure 1.

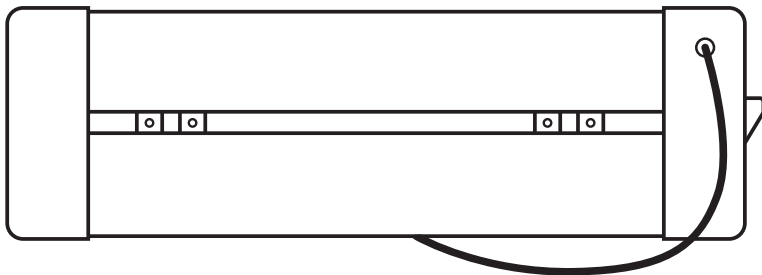
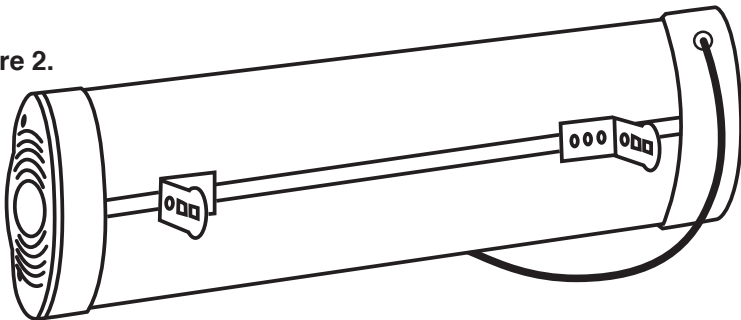

Figure 2.



INSTALLATION ON THE WALL OR CEILING

STEP 2:

The other 2 brackets are fastened by using the 4 long screws and their matching plastic accessories at the appropriate distance on the wall parallel to the floor (At least 2 yd. from the floor and at least 0.5 yd. from the ceiling) (Figure 3).

Figure 3.

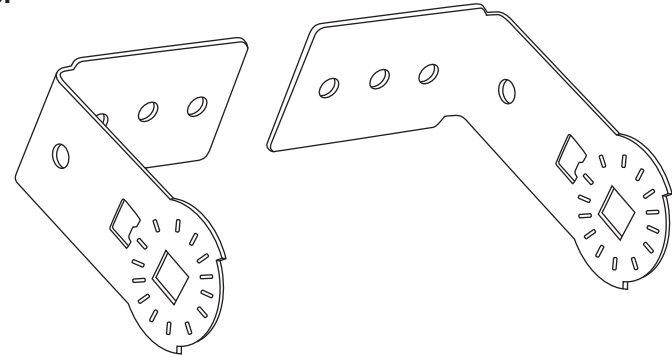

STEP 3:

Join the brackets on the heater with the brackets fastened on the wall using 2 bolts and their matching washers and wing nuts (Figure 4). Install the heater at the proper angle (in the direction of the area to be heated).

Refer to "Important Notices For Installation" on the next page.

Figure 4.

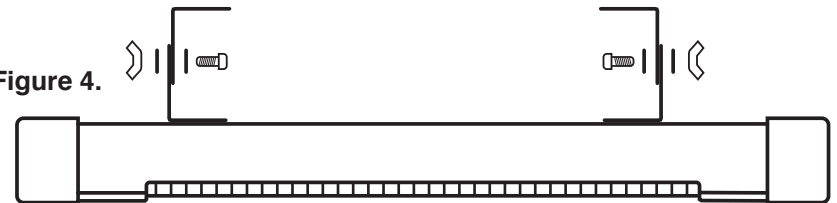

NOTES: Angle of heater can be adjusted by partially loosening the wingnuts, adjusting the heater angle, then retightening. Be sure the tabs interlock with the holes in the brackets.

Electric wiring for the heater has to be done by a qualified specialist if needed.

WARNING! DO NOT DIRECT HEATER AT THE CEILING, WALL OR OTHER NEARBY SURFACE OR OBJECT.

IMPORTANT NOTICES FOR INSTALLATION

Install the heater in the horizontal position, i.e. parallel to the floor.

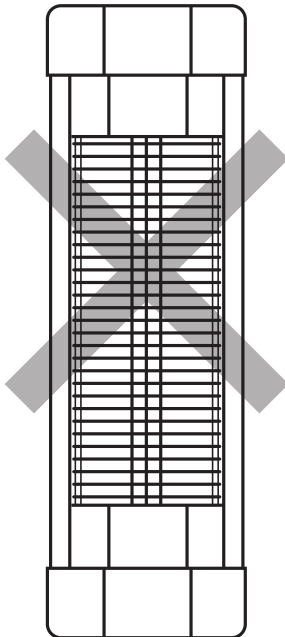
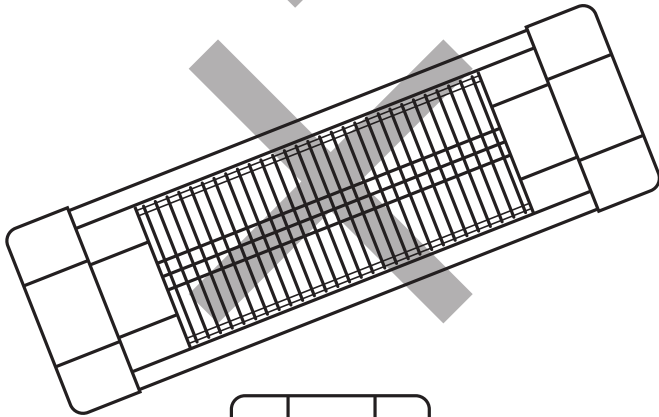

IMPORTANT NOTICES FOR INSTALLATION

Direct the heater in the appropriate angle.

