

## English Telephone Faucet Body

by Randolph Morris

Item#: 146S

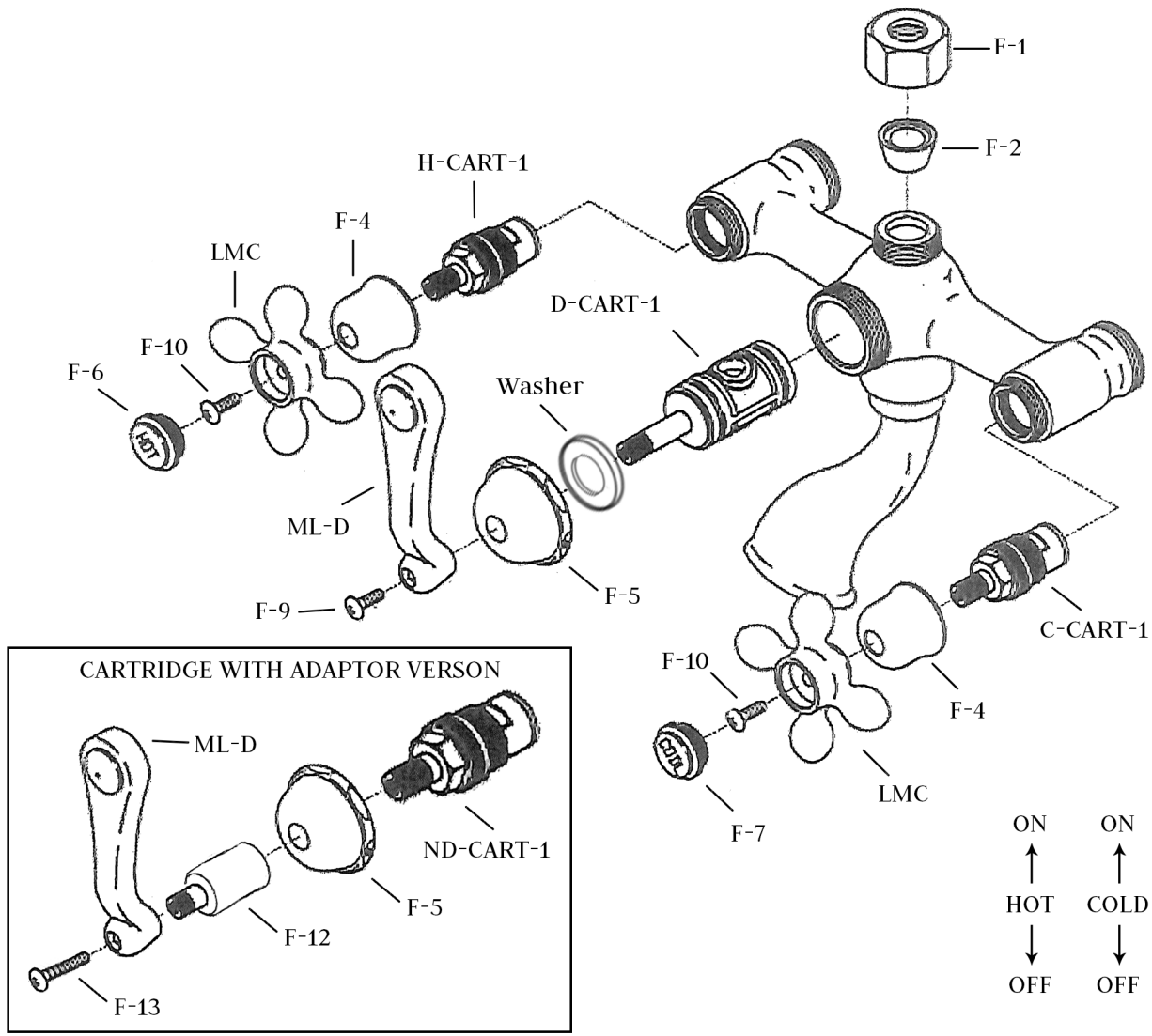

Unpack and check all the parts, and read the instructions.

PART NO.	DESCRIPTION	QTY
C-CART-1	COLD CARTRIDGE (BLUE)	1
D-CART-1	DIVERTER CARTRIDGE	1
F-1	RISER NUT	1
F-2	RISER CONE WASHER	1
F-4	BELL NUT - HOT & COLD	2
F-5	DIVERTER BELL NUT	1
F-6	HOT CERAMIC BUTTON	1
F-7	COLD CERAMIC BUTTON	1
F-9	FINISHED SCREW	1
F-10	UNFINISHED SCREW	2
F-12	ADAPTOR	1
F-13	LONG FINISHED SCREW	1
H-CART-1	HOT CARTRIDGE (RED)	1
LMC	CROSS HANDLE	2
ML-D	DIVERTER HANDLE	1
ND-CART-1	DIVERTER CARTRIDGE (ADAPTOR VERSION)	1



# Handshower & Cradle

by Randolph Morris

Item#: 144B

Unpack and check all the parts, and read the instructions.

PART NO.	DESCRIPTION	QTY
CK-1	HANSHOWER HEAD	1
CK-2	HANSHOWER HANDLE	1
CK-3	HANSHOWER HOSE	1
CK-4	HANSHOWER HOSE WASHERS	2
CK-10	HANSHOWER FAUCET CRADLE	1
CK-11	HANSHOWER CRADLE WASHER	1

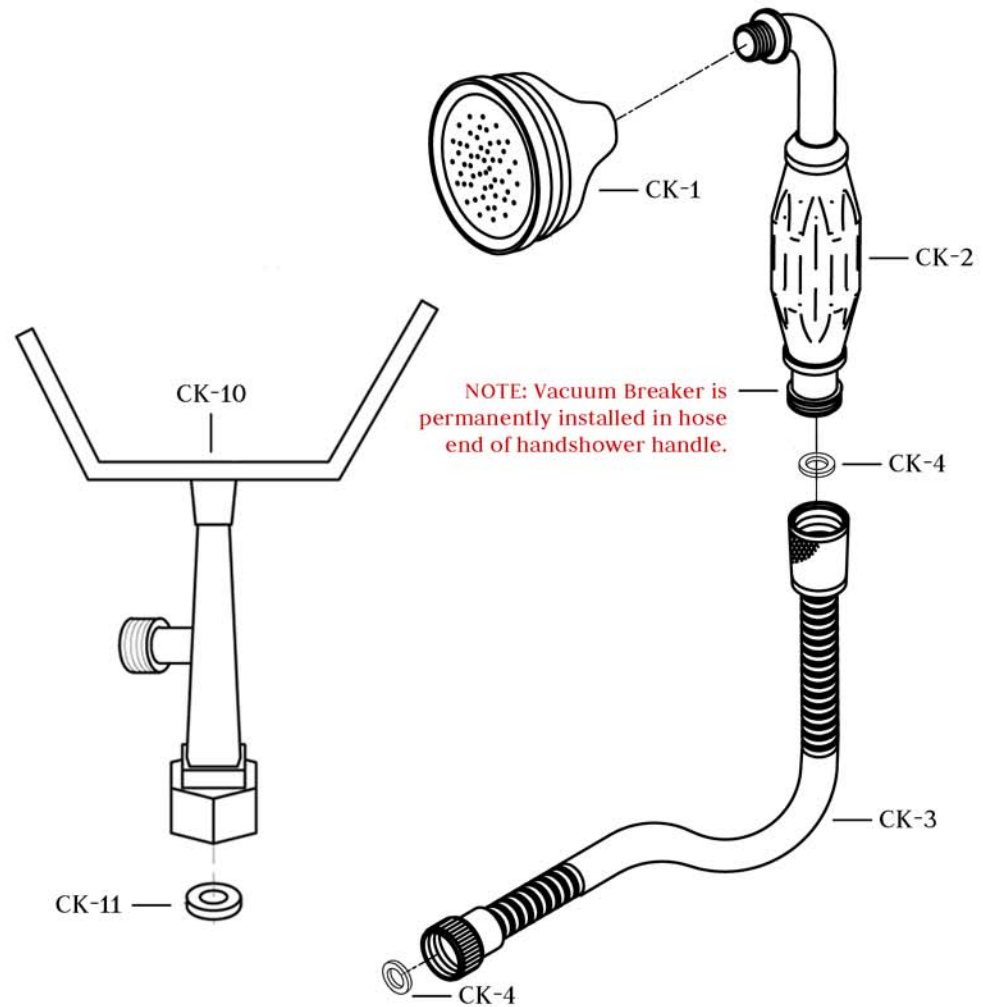

## COUPLER & SWING ARM PART SETS

**\*\*NOTE:** You may not receive all part sets listed below. Please refer to your order for your specific product.\*\*

**DECK MOUNT COUPLERS** - Either of these couplers can be used to attach a tub faucet to the rim of a tub.

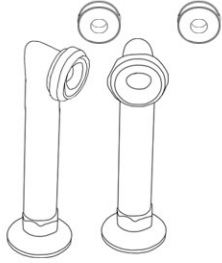

6" Deck Mount Couplers  
Part: 200

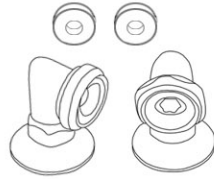

2" Deck Mount Couplers  
Part: 202

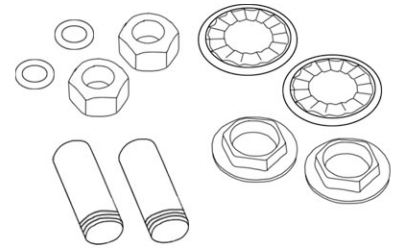

Deck Mount Hook Ups  
Part: RMT500 included in box 200 or 202

**BATHROOM WALL MOUNT COUPLERS** - Either of these couplers can be used to attach a tub faucet to the rim of a tub.

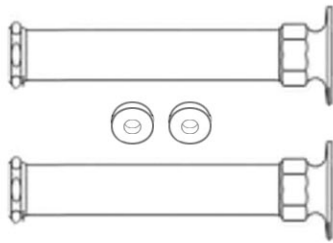

6" Bathroom Wall Mount Couplers  
Part: 170

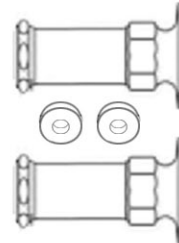

2" Bathroom Wall Mount Couplers  
Part: 160

**TUB WALL MOUNT COUPLERS** - Either of these couplers can be used to attach a tub faucet to the inside wall of a tub.

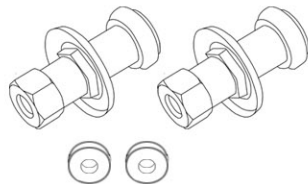

Straight Tub Wall Mount Couplers  
Part: 350

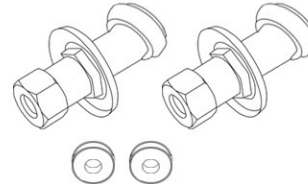

Adjustable Tub Wall Mount Couplers  
Part: A100

**DECK MOUNT /  
FREESTANDING SWING ARMS** -  
used between the couplers and the  
faucet body to create adjustable  
mounting widths.



Part: 300

**TUB WALL / BATHROOM WALL MOUNT SWING ARMS** -  
used between the faucet body and the tub or bathroom wall to create  
adjustable mounting widths.

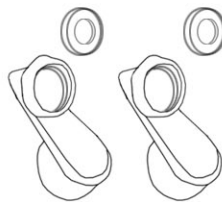

Part: 100

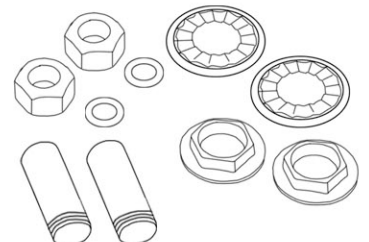

Deck Mount Hook Ups  
Part: T7550 included in box 100