

9' & 12' SHUFFLEBOARD TABLE - NG1205 - NG1214

Spec Sheet

ALL measurements are common except as listed below.

Item No.	Measurements			Finish	UPC Code
	X	Y	Z		
NG1205	108"	67.5"	20.25"	Walnut	672875902248
NG1210	108"	67.5"	20.25"	Dk. Cherry	672875902293
NG1212	144"	83.5"	30.25"	Walnut	672875902323
NG1214	144"	83.5"	30.25"	Dk. Cherry	672875902378

Finish Color Sample

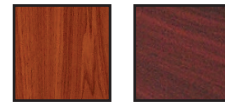

Walnut Dk. Cherry

Corners are 1" plywood with PVC laminate (Walnut or Dk. Cherry) and capped with gloss black ABS

Play surface is min. 1.375" thick solid finger jointed hardwood butcher block finished in a smooth gloss polyurethane w/poly-sealed underside. All tables are 15" W x 98" L (9') and 134" L (12')

Side and End Aprons are 5.75" W x 1" MDF with PVC laminate (Walnut or Dk. Cherry) and capped with matte black ABS



Leg Cabinets covered, inside and out, with PVC laminate (walnut or dk. cherry). Door has two 1.5" Antique Bronze cabinet hinges w/ magnet closer

22" x 23.75" x 5.75" Leg Cabinets have 1.125" sides with rounded corners, 5/8" top and shelf, 1/8" back, 3/8" door, and 2.625" base, all MDF

Accessories:
Includes four 2" dia. red pucks, four 2" dia. blue pucks, 1 table brush and 1 can of wax

Underside and support braces are 7/8" MDF with glued and screwed blocking
All structural components to be CARB certified MDF

6.5" dia. Antique Bronze ABS Leg Levelers w/ rubber bottoms



Play surface must be smooth and level with NO dips over 1/32" in depth and NO visible filler (see photo above).



2.75" deep gutters are covered, bottom and sides, with grey, synthetic fiber, ribbed carpeting.





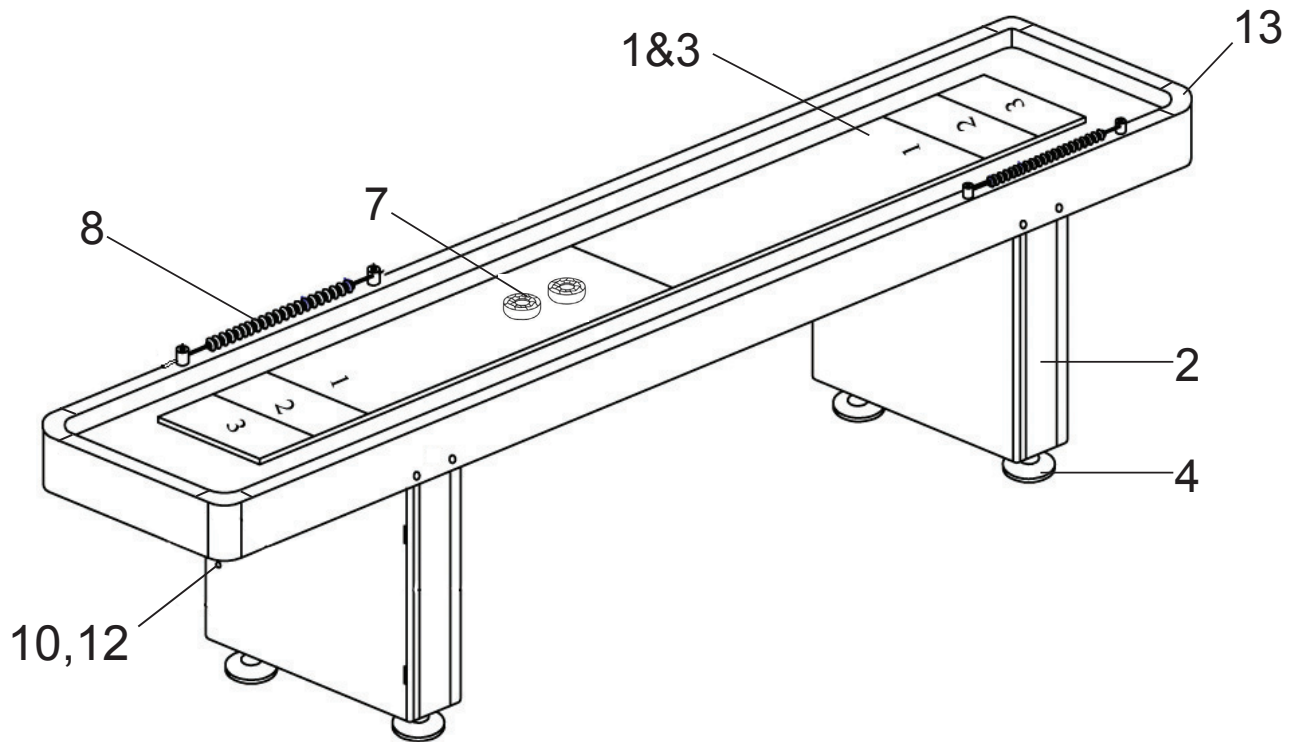

Securely fastened high quality black anodized steel Climate Adjusters, 13.5" x .75" square with 1/4" bolts and oversize washers. 3 on 9' & 4 on 12' tables

9' WALNUT SHUFFLEBOARD TABLE - NG1205

Spec Sheet

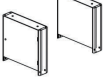

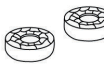
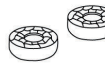

PARTS

#1&3 NGP2611 108" x 24" x 5.75" 1" MDF  x1 TABLE BODY AND PLAYFIELD 9'	#2 NGP2612 22" x 23.75" x 5.75" 5/8" MDF  x2 LEG PIECE	#4 NGP2603 6.5" Dia. x 3" ABS/Steel/Rubber  x4 LEG LEVELER	#7 NGP2606 2" Dia. x .75", 9.5 oz. Polished Steel/ABS  x4 RED PUCK	#7 NGP2607 2" Dia. x .75", 9.5 oz. Polished Steel/ABS  x4 BLUE PUCK	#8 NGP2615 15" x .875" x 1.5" Wood/Steel  x2 MANUAL SCORER	#10&12 NGP2616 .875" Dia. x .875" Wood  x4 SCREW CAP & DOOR HANDLE
----------------------------------------------------------------------------------------------------------------------------------------------------------------------------------	--------------------------------------------------------------------------------------------------------------------------------------------------------------	------------------------------------------------------------------------------------------------------------------------------------------------------------------	--------------------------------------------------------------------------------------------------------------------------------------------------------------------------	----------------------------------------------------------------------------------------------------------------------------------------------------------------------------	--------------------------------------------------------------------------------------------------------------------------------------------------------------------	--------------------------------------------------------------------------------------------------------------------------------------------------------------------------------

#13 NGP2620 3.5" x 3.5" x 1.5" ABS Plastic  x4 PLASTIC CORNER CAP

HARDWARE PACK - NG2604

(sealed in individual numbered poly bags and then bagged as set)

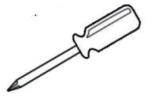
#5 x12  2-1/4" BOLT	#6 x12  FLAT WASHER	#9 x4  1-1/2" SCREW	#11 x1  WRENCH	ADDITIONAL EQUIPMENT REQUIRED:  PHILLIPS HEAD SCREWDRIVER
---------------------------------------------------------------------------------------------------------------------	---------------------------------------------------------------------------------------------------------------------	----------------------------------------------------------------------------------------------------------------------	------------------------------------------------------------------------------------------------------------------	------------------------------------------------------------------------------------------------------------------------------------------------------





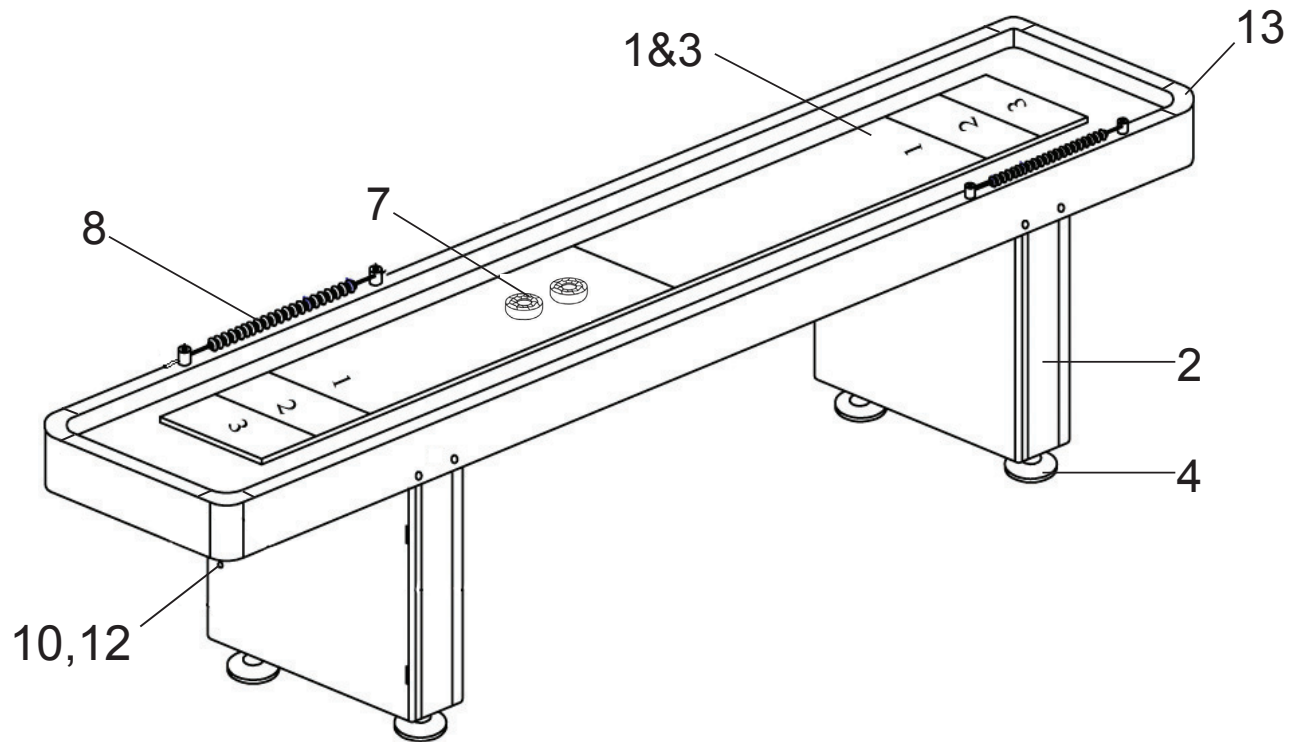

All dimensions given are approx. and represent the size at the widest point of that dimension.

9' DK. CHERRY SHUFFLEBOARD TABLE - NG1210

Spec Sheet



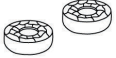



PARTS

#1&3 NGP2601 108" x 24" x 5.75" 1" MDF  x1 TABLE BODY AND PLAYFIELD 9'	#2 NGP2602 22" x 23.75" x 5.75" 5/8" MDF  x2 LEG PIECE	#4 NGP2603 6.5" Dia. x 3" ABS/Steel/Rubber  x4 LEG LEVELER	#7 NGP2606 2" Dia. x .75", 9.5 oz. Polished Steel/ABS  x4 RED PUCK	#7 NGP2607 2" Dia. x .75", 9.5 oz. Polished Steel/ABS  x4 BLUE PUCK	#8 NGP2608 15" x .875" x 1.5" Wood/Steel  x2 MANUAL SCORER	#10&12 NGP2610 .875" Dia. x .875" Wood  x4 SCREW CAP & DOOR HANDLE
----------------------------------------------------------------------------------------------------------------------------------------------------------------------------------	--------------------------------------------------------------------------------------------------------------------------------------------------------------	------------------------------------------------------------------------------------------------------------------------------------------------------------------	--------------------------------------------------------------------------------------------------------------------------------------------------------------------------	----------------------------------------------------------------------------------------------------------------------------------------------------------------------------	--------------------------------------------------------------------------------------------------------------------------------------------------------------------	--------------------------------------------------------------------------------------------------------------------------------------------------------------------------------

#13 NGP2620 3.5" x 3.5" x 1.5" ABS Plastic  x4 PLASTIC CORNER CAP

HARDWARE PACK - NG2604

(sealed in individual numbered poly bags and then bagged as set)

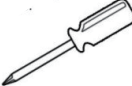
#5 x12  2-1/4" BOLT	#6 x12  FLAT WASHER	#9 x4  1-1/2" SCREW	#11 x1  WRENCH	ADDITIONAL EQUIPMENT REQUIRED:  PHILLIPS HEAD SCREWDRIVER
---------------------------------------------------------------------------------------------------------------------	---------------------------------------------------------------------------------------------------------------------	----------------------------------------------------------------------------------------------------------------------	------------------------------------------------------------------------------------------------------------------	------------------------------------------------------------------------------------------------------------------------------------------------------



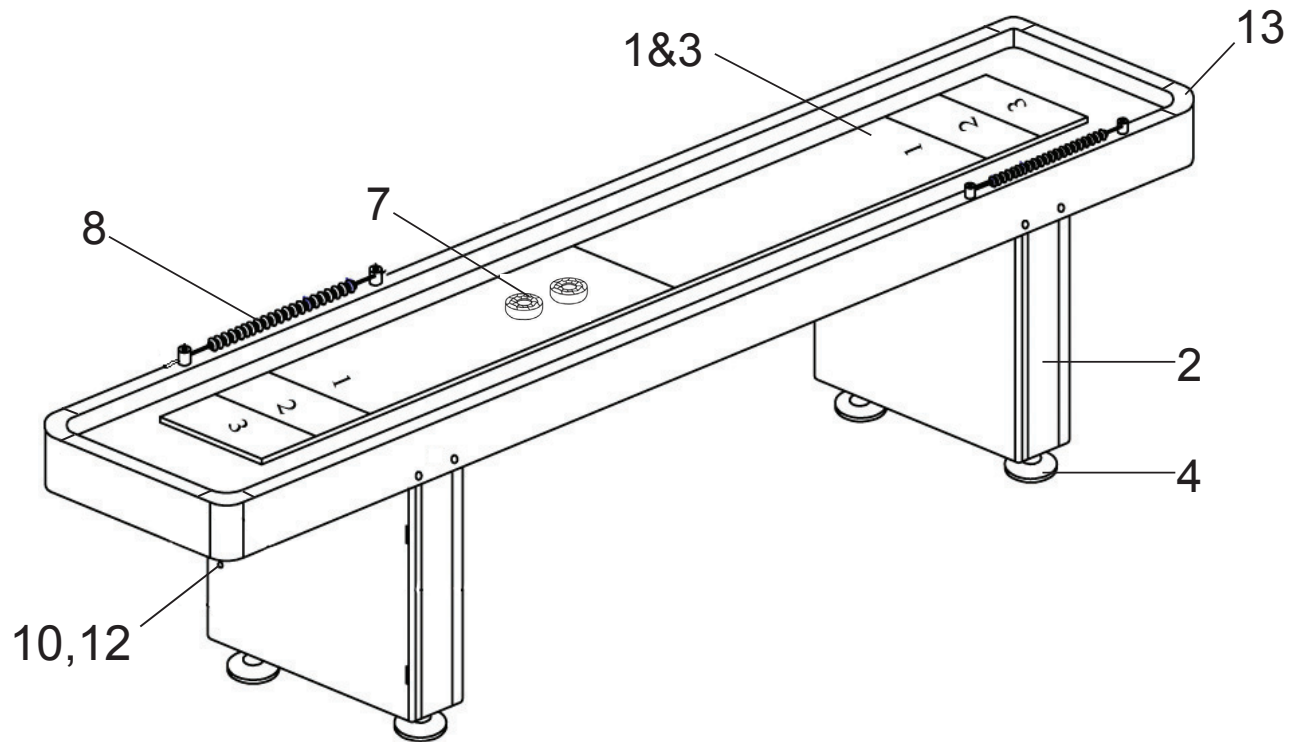

All dimensions given are approx. and represent the size at the widest point of that dimension.

12' WALNUT SHUFFLEBOARD TABLE - NG1212

Spec Sheet

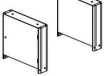

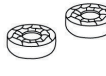

PARTS

#1&3 NGP2613 144" x 24" x 5.75" 1" MDF  x1 TABLE BODY AND PLAYFIELD 12'	#2 NGP2612 22" x 23.75" x 5.75" 5/8" MDF  x2 LEG PIECE	#4 NGP2603 6.5" Dia. x 3" ABS/Steel/Rubber  x4 LEG LEVELER	#7 NGP2606 2" Dia. x .75", 9.5 oz. Polished Steel/ABS  x4 RED PUCK	#7 NGP2607 2" Dia. x .75", 9.5 oz. Polished Steel/ABS  x4 BLUE PUCK	#8 NGP2615 15" x .875" x 1.5" Wood/Steel  x2 MANUAL SCORER	#10&12 NGP2616 .875" Dia. x .875" Wood  x4 SCREW CAP & DOOR HANDLE
-----------------------------------------------------------------------------------------------------------------------------------------------------------------------------------	--------------------------------------------------------------------------------------------------------------------------------------------------------------	------------------------------------------------------------------------------------------------------------------------------------------------------------------	--------------------------------------------------------------------------------------------------------------------------------------------------------------------------	----------------------------------------------------------------------------------------------------------------------------------------------------------------------------	--------------------------------------------------------------------------------------------------------------------------------------------------------------------	--------------------------------------------------------------------------------------------------------------------------------------------------------------------------------

#13 NGP2620 3.5" x 3.5" x 1.5" ABS Plastic  x4 PLASTIC CORNER CAP

HARDWARE PACK - NG2604

(sealed in individual numbered poly bags and then bagged as set)

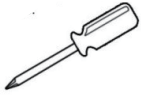
#5 x12  2-1/4" BOLT	#6 x12  FLAT WASHER	#9 x4  1-1/2" SCREW	#11 x1  WRENCH	ADDITIONAL EQUIPMENT REQUIRED:  PHILLIPS HEAD SCREWDRIVER
---------------------------------------------------------------------------------------------------------------------	---------------------------------------------------------------------------------------------------------------------	----------------------------------------------------------------------------------------------------------------------	------------------------------------------------------------------------------------------------------------------	------------------------------------------------------------------------------------------------------------------------------------------------------



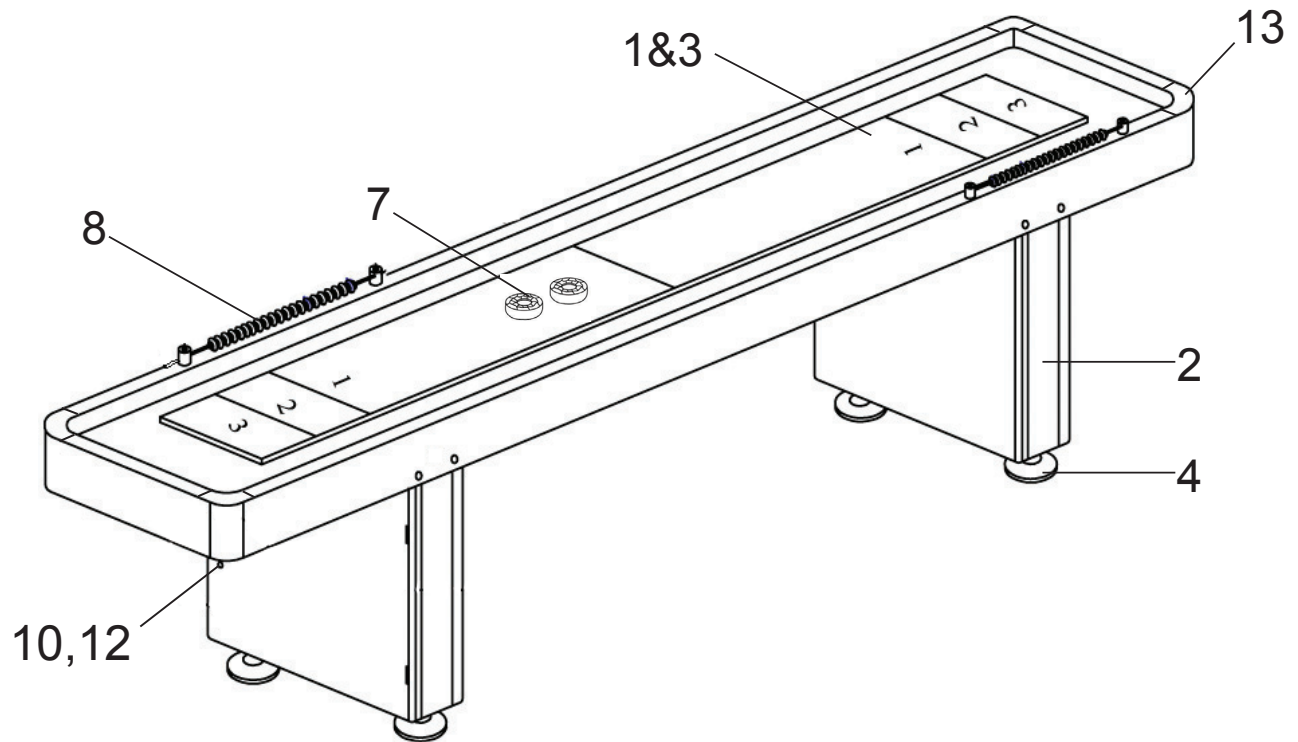

All dimensions given are approx. and represent the size at the widest point of that dimension.

12' DK. CHERRY SHUFFLEBOARD TABLE - NG1214

Spec Sheet



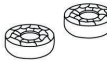
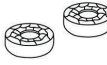

PARTS

#1&3 NGP2617 108" x 24" x 5.75" 1" MDF  x1 TABLE BODY AND PLAYFIELD 12'	#2 NGP2602 22" x 23.75" x 5.75" 5/8" MDF  x2 LEG PIECE	#4 NGP2603 6.5" Dia. x 3" ABS/Steel/Rubber  x4 LEG LEVELER	#7 NGP2606 2" Dia. x .75", 9.5 oz. Polished Steel/ABS  x4 RED PUCK	#7 NGP2607 2" Dia. x .75", 9.5 oz. Polished Steel/ABS  x4 BLUE PUCK	#8 NGP2608 15" x .875" x 1.5" Wood/Steel  x2 MANUAL SCORER	#10&12 NGP2610 .875" Dia. x .875" Wood  x4 SCREW CAP & DOOR HANDLE
-----------------------------------------------------------------------------------------------------------------------------------------------------------------------------------	--------------------------------------------------------------------------------------------------------------------------------------------------------------	------------------------------------------------------------------------------------------------------------------------------------------------------------------	--------------------------------------------------------------------------------------------------------------------------------------------------------------------------	----------------------------------------------------------------------------------------------------------------------------------------------------------------------------	--------------------------------------------------------------------------------------------------------------------------------------------------------------------	--------------------------------------------------------------------------------------------------------------------------------------------------------------------------------

#13 NGP2620 3.5" x 3.5" x 1.5" ABS Plastic  x4 PLASTIC CORNER CAP

HARDWARE PACK - NG2604

(sealed in individual numbered poly bags and then bagged as set)

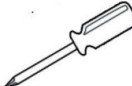
#5 x12  2-1/4" BOLT	#6 x12  FLAT WASHER	#9 x4  1-1/2" SCREW	#11 x1  WRENCH	ADDITIONAL EQUIPMENT REQUIRED:  PHILLIPS HEAD SCREWDRIVER
---------------------------------------------------------------------------------------------------------------------	---------------------------------------------------------------------------------------------------------------------	----------------------------------------------------------------------------------------------------------------------	------------------------------------------------------------------------------------------------------------------	------------------------------------------------------------------------------------------------------------------------------------------------------

All dimensions given are approx. and represent the size at the widest point of that dimension.