

100ICLCR5

Product Data Sheet

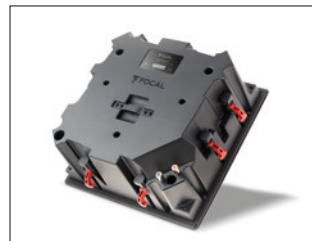
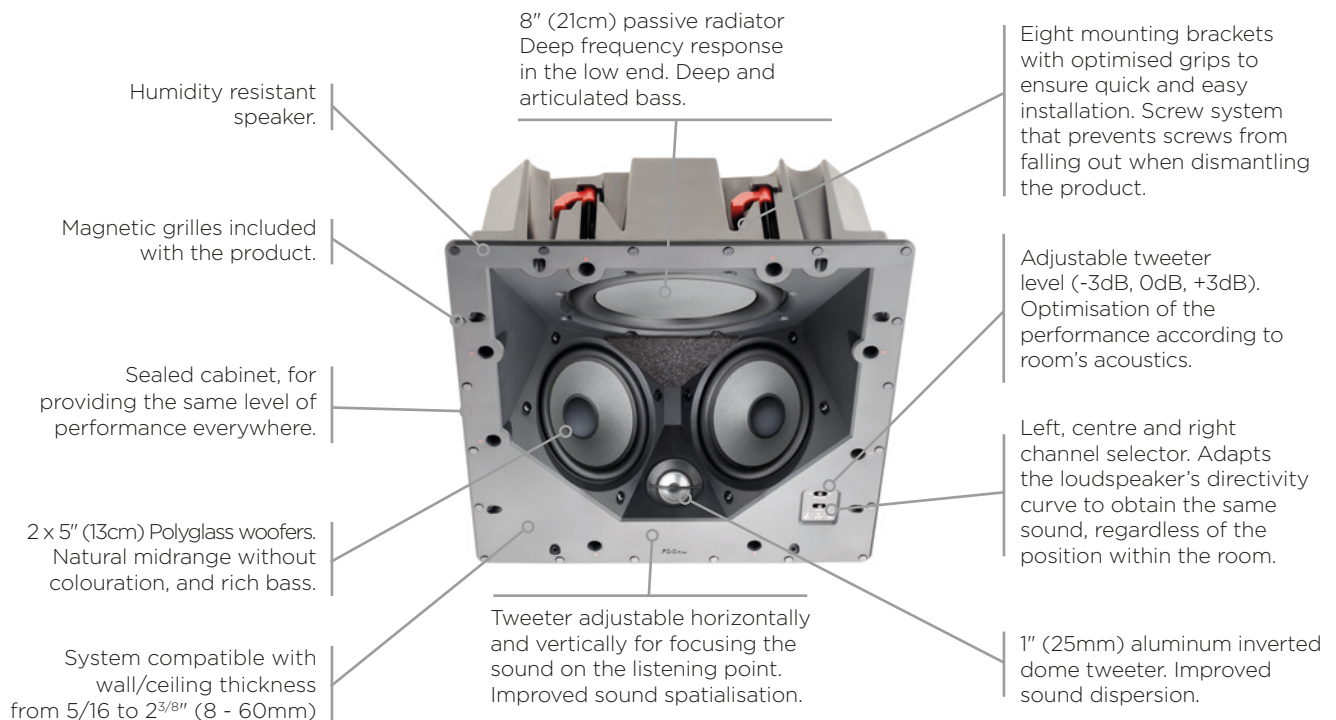

Key points

- A Home Cinema system totally integrated into the ceiling for total discretion.
- A loudspeaker with five uses (front left, centre or right channels; rear left and rear right channels)
- The best performance in terms of use (left, right or right channel selector and adjustable tweeter level)
- Product designed and developed in France by Focal
- Very balanced mid-range for improved intelligibility for Home Cinema set-ups
- Supplied with a magnetic grille and ready to paint to ensure perfect integration

Technical Specifications

Type	2-way in-ceiling
Drivers	2 x 5" (13cm) Polyglass woofers, 1" (25mm) inverted dome tweeter, 8" (21cm) Polyglass passive radiator
Sensitivity (2.83V/1m)	92dB
Frequency response (+/-3dB)	65Hz - 23kHz
Low frequency point (-6dB)	55Hz
Nominal impedance	8 Ω
Minimal impedance	4.6 Ω
Recommended amplifier power	25 - 120W
External dimensions (HxWxD)	13 ¹⁵ / ₁₆ "x13 ¹⁵ / ₁₆ "x5 ⁵ / ₁₆ " (354x354x150mm)
Cut-Out diameter (HxW)	12 ¹⁵ / ₁₆ "x12 ¹⁵ / ₁₆ " (328x328mm)
Depth from wall	6" (152mm)
Net weight (with front grille)	11.6lbs (5.3kg)
Packing dimensions (WxDxH)	16 ¹ / ₁₆ "x 16 ¹ / ₁₆ "x7 ¹ / ₂ " (408x408x190mm)
Total weight (with packaging)	15.8 lbs (7.2kg)

Dimensions

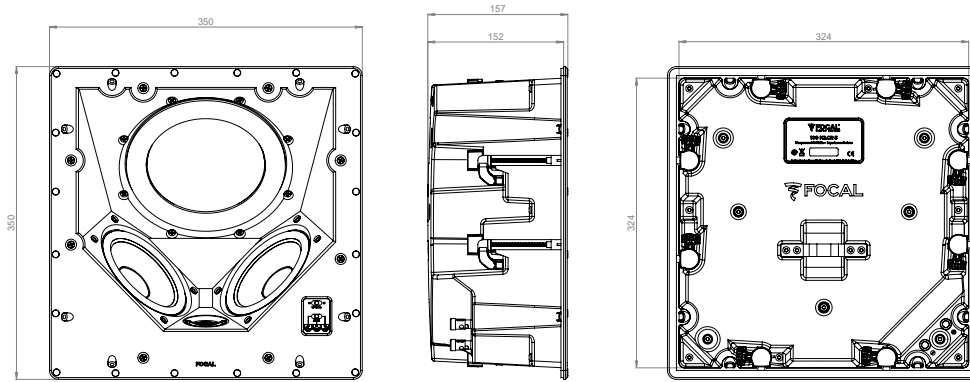

Directivity Measurements

Horizontal (right channel)

Level (dB)

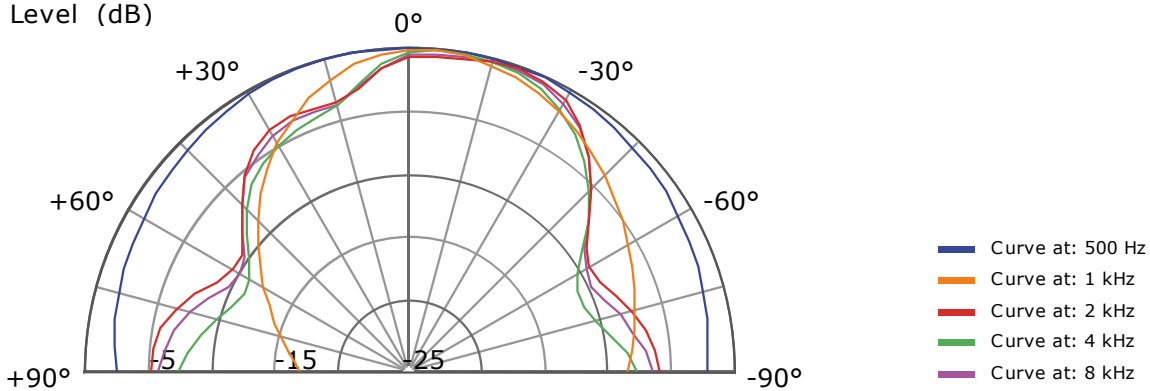

Horizontal (central channel)

Level (dB)

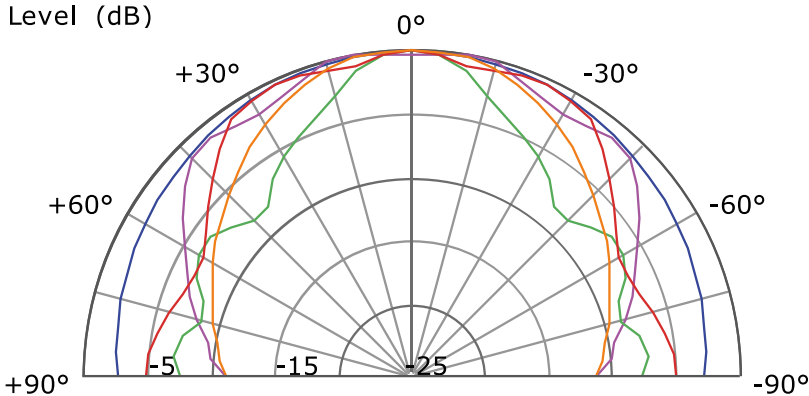

Vertical

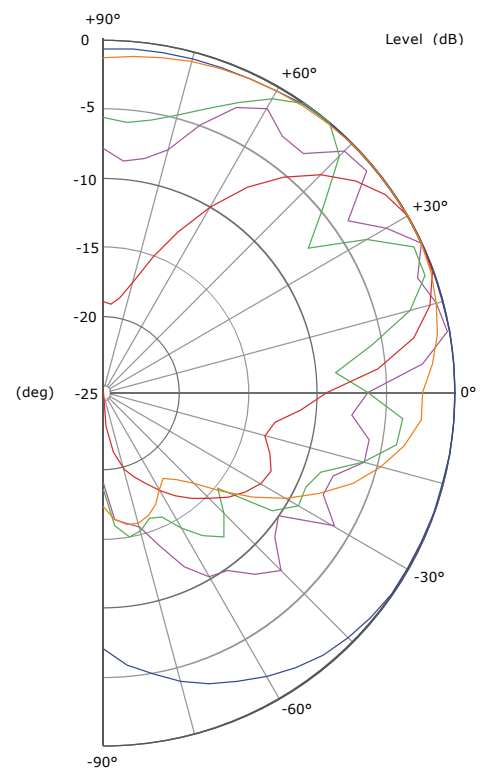

Frequency Response

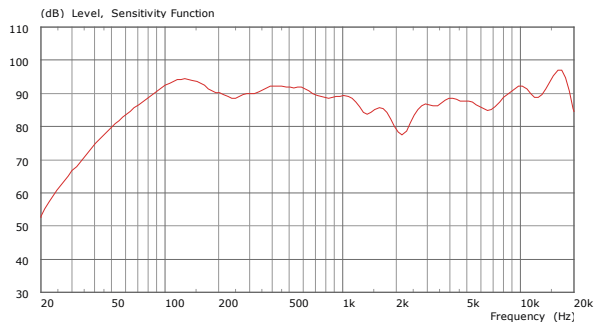

100ICLR5 Speaker level Calculation Table

Horizontal (right channel)

Power/Distance	1m	2m	5m
1W (2.83V)	92dB	86dB	78dB
5W (8.94V)	102dB	96dB	88dB
10W (12.6V)	105dB	99dB	91dB
20W (15.5V)	107dB	101dB	93dB

Summary	125Hz	250Hz	500Hz	1kHz	2kHz	4kHz	8kHz
SPL (2.83V/1m) (dB)	92	89	91.5	89.5	83	87	89
Opening Angle at -6dB	360°	360°	360°	35°/+60°	-45°/+90°	-35°/+50°	40°/+50°

Horizontal (central channel)

Power/Distance	1m	2m	5m
1W (2.83V)	92dB	86dB	78dB
5W (8.94V)	102dB	96dB	88dB
10W (12.6V)	105dB	99dB	91dB
20W (15.5V)	107dB	101dB	93dB

Summary	125Hz	250Hz	500Hz	1kHz	2kHz	4kHz	8kHz
SPL (2.83V/1m) (dB)	92	89	91.5	89.5	80	90	89
Opening Angle at -6dB	360°	360°	340°	100°	110°	70°	120°