

CONTENTS

- 04 Caster Wheels - Two Standard + Two with Brakes
- 02 Slatted Side Racks
- 06 Supporting Cross Bars
- 12 Bolts - 5/16 x 1-5/8
- 12 Lock Washers - 5/16
- 08 Support U-Brackets

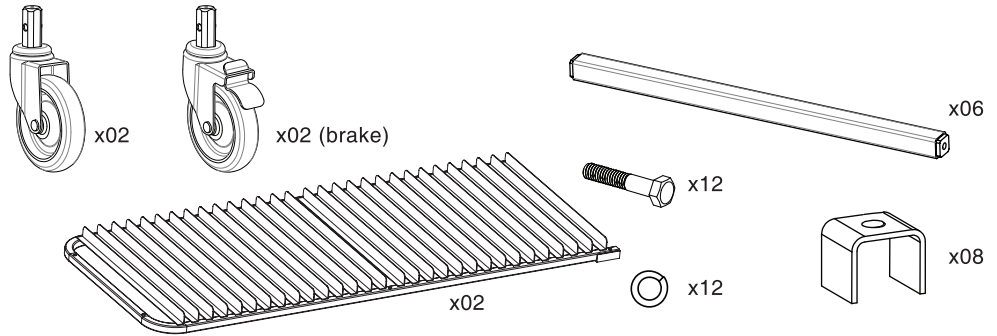

*Contents are not to scale to each other

1 ASSEMBLE THE RACK

- Preassemble the provided hardware:
 >> Insert a bolt into lock washer, then into U-bracket.
- Insert each bolt/washer assembly through the hole on side rack and align each cross bar with the same hole on the opposite side. Thread bolt into hole on bar and hand tighten.
 >> Repeat for the other bars on both side racks.
- Align the left with the right side rack. Insert bolt/washer assembly and attach side racks together.

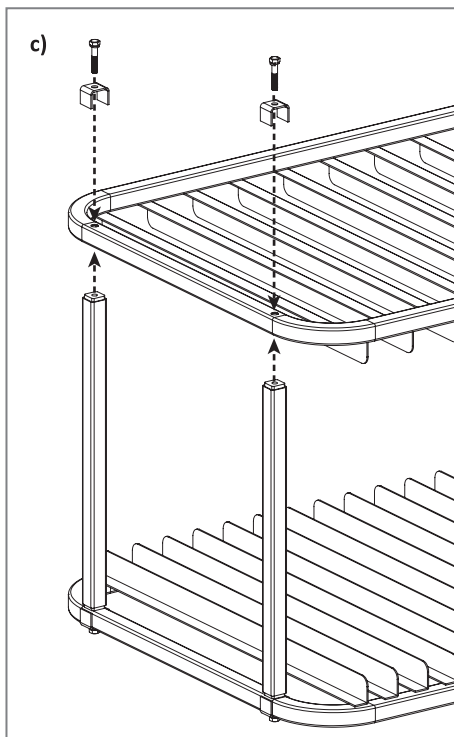
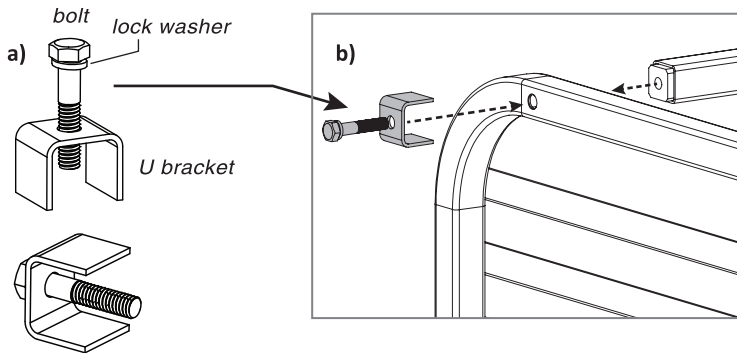

2 ATTACH CASTER WHEELS

- While assembled rack is laying flat, insert caster into bottom of rack.
- Insert bolt with a lock washer into side of rack and through caster mount, and hand tighten.
- Repeat for remaining caster wheels.

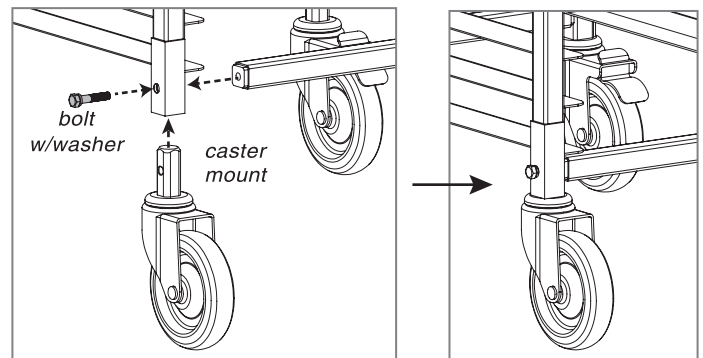

NOTE:
 Mount the two casters with brakes together on the same end (either front or back).

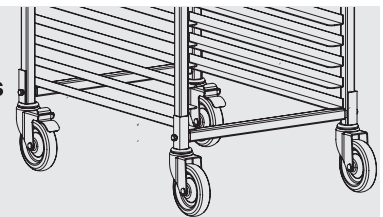

3 FINAL CHECK

- Stand the rack upright on a level surface/floor.
- All casters must be touching the floor evenly.
- Firmly tighten all bolts to ensure they are secure.



DO NOT OVERTIGHTEN BOLTS.

Overtightening may cause stripped threads and the bolt will not function properly.