

HDBaseT 4K UHD Extender Set with 1-way PoH and Bidirectional IR & RS-232 (70m/230ft)

EX-70-H2

WyreStorm

Quickstart Guide

 WyreStorm recommends reading through this document in its entirety to become familiar with the product's features prior to starting the installation process.



In the Box

- 1x EX-70-H2 Transmitter
- 1x EX-70-H2 Receiver
- 1x 18V DC 1A Power Supply (US/UK/EU)
- 2x 3-pin Screw Down Phoenix Connectors
- 2x Wide-band IR Emitters
- 2x Wide-band IR Receivers (30-50KHz)
- 4x Mounting Brackets (1 pr for TX and 1 pr for RX)
- 1x Quickstart Guide (this document)

Basic Wiring Diagram

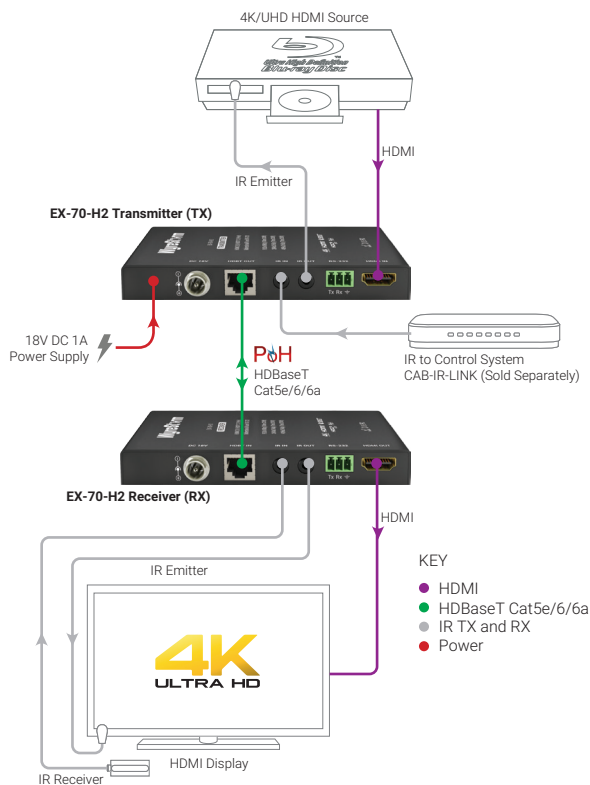

IMPORTANT!

Disconnecting and connecting (hot plugging) HDMI or HDBaseT while devices are powered on may cause damage. WyreStorm recommends powering off devices before disconnecting these connections.

Additional Information

This Quickstart Guide provides the basic steps for the common uses of this product. Detailed installation and configuration information may be found in the download tab located on the product page.

Installation

Before Beginning

- WyreStorm recommends visiting the product page before installing this product for updates to this Quickstart Guide as well as other information about the product.
- Verify that all items are included in the packaging per the **In the Box** list.

Pre Wire

- Run a Cat5e/6/6a cable from the matrix location to the receiver location. Terminate the cable per the **HDMI/HDBaseT Wiring** section.
- If using 3rd party IR emitters or connecting blocks at either the transmitter or receiver, run the wire and terminate per the **IR TX (Emitter) Wiring** section.
- (Optional) If using RS-232 pass-through, run the wire and terminate per the **RS-232 Wiring** section.
- (Optional) If using 3rd party IR receivers at either the transmitter or receiver, run the wire and terminate per the **IR RX (Receiver) Wiring** section.

Transmitter Installation

- Connect an HDMI source to the **HDMI In** on the transmitter using an HDMI cable from a high quality brand such as **WyreStorm Express**.
- (Optional) Place an IR emitter onto the source device near the device's IR receiver and connect it the **IR TX** port.
- Connect the cable created in **Pre Wire** step 1 to the **HDBT In**.
- (Optional) Connect the 3-pin connector to the **RS-232** port on the transmitter and the opposite end to a port on a control system.
- If using PoH from the transmitter to power the receiver, connect the included 18V DC 1A power supply to the 18V DC 1A jack.

Receiver Installation

- Connect the **HDMI Out** on the receiver to an input on the display using an HDMI cable from a high quality brand such as **WyreStorm Express**.
- (Optional) Place an IR emitter onto the source device near the device's IR receiver and connect it the **IR TX** port.
- Connect the cable created in **Pre Wire** step 1 to the **HDBT In**.
- (Optional) If using RS-232 pass-through, connect the 3-pin connector to the **RS-232** port on the receiver and the opposite end to a port on the device being controlled.
- If not using PoH from the transmitter to power the receiver, connect the included 18V DC 1A power supply to the 18V DC 1A jack.

Front Panel (TX/RX)

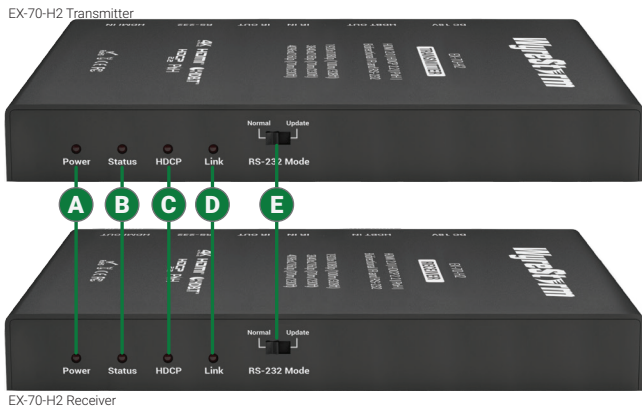

A Power LED	Solid: The receiver is powered On Off: The receiver is powered Off
B Status LED	Flashing: The receiver is operating normally. Off: The receiver is Not operating normally.
C HDCP LED	Solid: HDCP content is present. Flashing: HDCP content is not present. Off: No signal.
D LINK LED	Solid: Link to receiver has been established. Flashing: Link to receiver has not been established.
E RS-232 Mode	Switches the mode for the RS-232 port. Normal: RS-232 HDBaseT pass-through. Update: RS-232 firmware update.

Rear Panel (TX/RX)

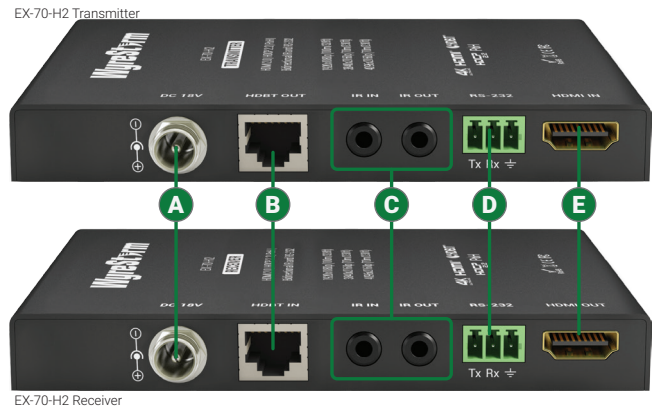

A Power Input	5.5mm Screw Down Barrel Jack 2-pin Phoenix Connector Connect to the included 18V DC 1A power supply to the transmitter. A power supply is not required on the receiver as it will be powered using PoH. See Power Supply Wiring for important information.
B Status LED	8-pin RJ-45 female 10/100 Mbps auto-negotiating Connect the transmitter HDBT Out to receiver HDBT In using the cable created in Pre Wire step 1.
C HDCP LED	IR TX - 3.5mm (1/8in) Mono Jack: Connect to the supplied IR emitter to control a local device from the remote display location via HDBaseT. IR RX - 3.5mm (1/8in) Stereo Jack: Connect to the supplied IR receiver to send IR to the remote display location via HDBaseT. See IR Wiring for more information.
D LINK LED	19-pin type A HDMI female Supports HDMI and DVI/D with adapter
E RS-232 Mode	3-pin Phoenix Connector Used to transmit RS-232 over HDBaseT to the remote location and for firmware updates. See RS-232 Wiring for more information.

HDMI/HDBaseT Wiring

⚠️ IMPORTANT! Wiring Guidelines

- The use of patch panels, wall plates, cable extenders, kinks in cables, and electrical or environmental interference can have an adverse effect on HDMI and HDBaseT transmission limiting performance. Steps should be taken to minimize these factors (or remove completely) during installation for best results.
- While similar in nature, the HDBaseT protocol is different than Ethernet and voltages provided for PoH can be higher than those provided by PoE. For this reason, never connect an HDBaseT link to an Ethernet router or switch to avoid damaging the connected devices.

Wiring for HDBaseT follows the EIA T568B standard.

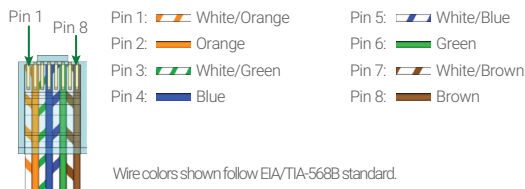

Resolutions Distances

The type of category cable used and the distance between the matrix and receiver can restrict the available video resolution. Refer to **Video Resolutions** in the **Specifications** table for the max distance based on resolution.

IR Wiring

IR TX (Emitter) Wiring

Connection for IR TX (transmit) uses a 3.5mm (1/8in) mono plug.



IR RX (Receiver) Wiring

Connection for IR RX (receive) uses a 3.5mm (1/8in) stereo jack that outputs +5V DC to power the included IR receiver.

⚠️ IMPORTANT! IR TX Connection Guidelines

- 3rd party IR receivers may require a different voltage, refer to the documentation provided with the IR receiver before making any connections to avoid damaging the device.

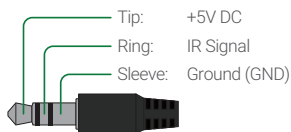

- When connecting to an IR control system use the **WyreStorm CAB-IR-LINK** cable to remove the sleeve +5V DC.

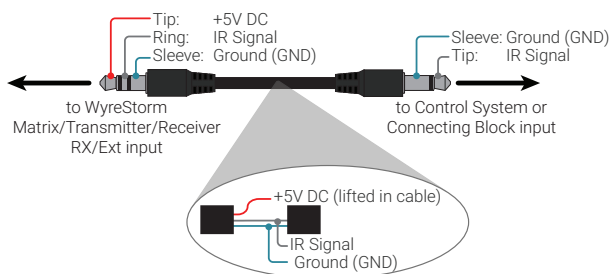

RS-232 Wiring

RS-232 Connection Guidelines

The following wiring diagram shows the pinouts for the extender set. While not shown, connect the TX (transmit) to RX (receive) pins at the control system or PC side of the cable.

Most control systems and computers are DTE where pin 2 is RX, this can vary from device to device. Refer to the documentation for the connected device for pin functionality to ensure that the correct connections can be made.

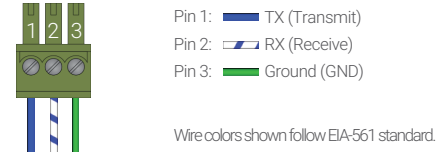

RS-232 Mode Settings

The RS-232 connector is used to transmit RS-232 over HDBaseT to the remote location and for firmware updates. Ensure that the RS-232 Mode switch in the proper position for the operation being performed.

Set the mode switch to Normal to transmit RS-232 signals from the TX to the RX for controlling devices in the remote location.

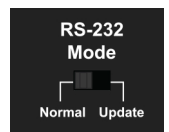

Set the mode switch to the Update position to install a firmware update in either the TX or RX.

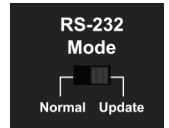

Power Supply Wiring

The EX-70-H2 can supply power from the transmitter to the receiver using PoH on the same category cable that transmits audio and video. The included power must be connected to the transmitter in order to power the receiver. Should distance of the category cable or other factors prevent PoH from being used, connect an 18V DC 1A power supply to both devices. Additional power supplies may be purchased from WyreStorm.

Specifications

Audio and Video		
Inputs	Transmitter: 1x HDMI 19-pin type A Receiver: 1x HDBaseT 8-pin RJ-45 female	
Outputs	Transmitter: 1x HDBaseT 8-pin RJ-45 female Receiver: 1x HDMI 19-pin type A	
Audio Formats	2ch PCM Up to 7.1 DTS-X and Dolby Atmos	
Video Resolutions (Max)	HDMI	
	1920x1080p @60Hz 36bit (15m/50ft)	
	3840x2160p @30Hz 4:4:4 24bit (7m/23ft)	
	3840x2160p @24Hz 4:2:0 HDR 10bit per channel (3m/9.8ft)	
	4096x2160p @60Hz 4:2:0 24bit (7m/23ft)	
	Using Cat6	Using Cat6a/7
	1920x1080p @60Hz 36bit (100m/328ft)	1920x1080p @60Hz 36bit (100m/328ft)
	3840x2160p @30Hz 4:4:4 24bit (70m/230ft)	3840x2160p @30Hz 4:4:4 24bit (100m/328ft)
	3840x2160p @24Hz 4:2:0 HDR 10bit per channel (35m/115ft)	3840x2160p @24Hz 4:2:0 HDR 10bit per channel (35m/115ft)
	4096x2160p @60Hz 4:2:0 24bit (70m/230ft)	4096x2160p @60Hz 4:2:0 24bit (100m/328ft)
Color Depth	1080p: 48bit 4K UHD: 24bit HDR @24p: 10bit per channel BT.2020	
Maximum Pixel Clock	297MHz	
Communication and Control		
HDMI	HDCP 2.2 EDID DVI/D supported with adapter (not included)	
HDBaseT	HDCP 2.2 EDID PoH (1-Way TX to RX) Bidirectional IR and RS-232	
IR	1x IR TX 3.5mm (1/8in) Mono Bidirectional over HDBaseT 1x IR RX 3.5mm (1/8in) Stereo Bidirectional over HDBaseT	
RS-232	1x 3-pin Screw Down Phoenix Connector Bidirectional over HDBaseT	
Power		
Power Supply	Input: 100~240V AC 50/60Hz Output: 18V DC 1A	
Max Power Consumption	26.5W	
Non-standard PoH	18V 9W	
Environmental		
Operating Temperature	32°F ~ 113°F (0°C ~ 45°C) 10% ~ 90%, non-condensing	
Storage Temperature	-4°F ~ 158°F (-20°C ~ 70°C) 10% ~ 90%, non-condensing	
Maximum BTU	90.42 BTU/hr	
Dimensions and Weight		
Height	17mm/00.67in	
Width	140mm/5.51in	
Depth	90.2mm/3.55in	
Weight	0.68kg/1.50lbs	
Regulatory		
Safety and Emission	CE FCC RoHS	

Troubleshooting

No or Poor Quality Picture (snow or noisy image)

- Verify that power is being supplied to the transmitter and receiving device and that both devices are powered on.

Note:

When using PoH, to power the receivers, verify that the HDBaseT cable is properly terminated per the [HDMI/HDBaseT Wiring](#) section.

- Verify that the matrix supports the output resolution of the source. See [Supported Video Resolutions](#).
- Verify that the matrix, receiver, and display support the output resolution of the source. Refer to **Video Resolutions** in the [Specifications](#) table.
- Verify that the receiving device and display support the output resolution of the source.
- If transmitting 3D or 4K, verify that the HDMI cables used are 3D or 4K rated.

Warranty Information

This product is covered by a 3 year limited parts and labor warranty. During this period there will be no charge for unit repair, component replacement or complete product replacement in the event of malfunction. The decision to repair or replace will be made by the manufacturer. This limited warranty only covers defects in materials or workmanship and excludes normal wear and tear or cosmetic damage.

Visit the product page located at wyrestorm.com for additional information on this product including important technical information not provided in this document and warranty terms & conditions.

- Verify that the HDBaseT cable is properly terminated per the [HDMI/HDBaseT Wiring](#) section.
- Verify that all source and HDBaseT connections are not loose and are functioning properly.

No or Intermittent 3rd party Device Control

Verify that the IR cable(s) is properly terminated. See [IR Wiring](#).

- Verify that the IR emitter is located near the IR receiver on the device.

Troubleshooting Tips:

- WyreStorm recommends using a cable tester or connecting the cable to other devices to verify functionality.
- Use a flashlight to locate the IR receiver behind any tinted panels on the device being control.

