

ring



Stick Up Cam Wired

1. Set up your Stick Up Cam Wired.

Download the Ring app.

The app walks you through setting up and managing your Stick Up Cam Wired.

Search for “Ring” in one of the app stores below, or visit: ring.com/app



Grab your Wi-Fi password.

You'll need it to set up your Stick Up Cam.
Write it down below so it's handy when you need it:

Your Wi-Fi password 

Let's get your Stick Up Cam ready.

First, slide off the bottom cover.

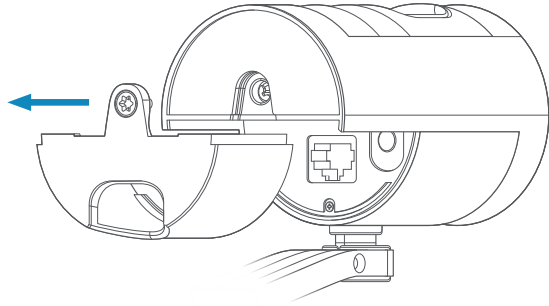

Do not reattach this cover until setup is complete!

Powering your Stick Up Cam

You can power Stick Up Cam in one of two ways: Plug it into an outlet (with USB), or plug it into an Ethernet port that supplies Power over Ethernet (or PoE).

Using PoE requires a special type of Ethernet switch or a dedicated PoE power supply, like the Ring PoE Adapter (sold separately).

i For outdoor use, install your PoE Adapter indoors, then run an Ethernet cable outdoors to your Stick Up Cam Wired.

How to power Stick Up Cam with USB:

Two USB power supplies are included: One for indoor use, and one for outdoor use.

Indoor

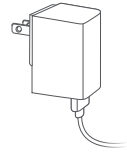

Outdoor

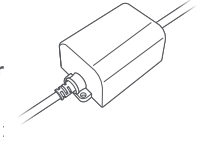

If you plan to install Stick Up Cam outdoors, secure the power supply to a wall or floor with the included screws.

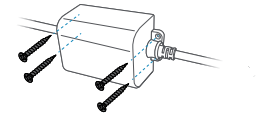

Feed your chosen USB cable through the hole in the bottom cover and plug it into your Stick Up Cam. Then, plug the power supply into an outlet.

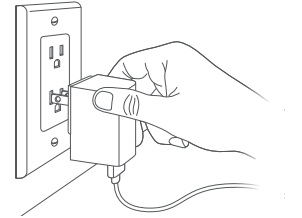
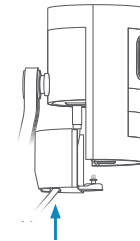

How to power Stick Up Cam with PoE:

Feed your Ethernet cable through the hole in the bottom cover and plug it into your Stick Up Cam. Then, plug the other end of the cable into an Ethernet port that supplies Power over Ethernet (or PoE).

Don't have Power over Ethernet?

If you want to use a wired network connection but don't have PoE, connect one of the included USB power supplies in addition to Ethernet, or purchase a Ring PoE Adapter.

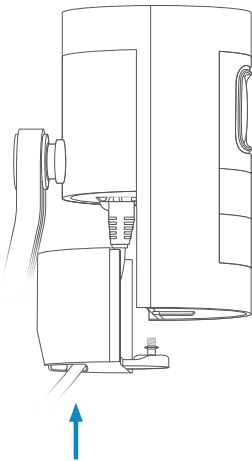

Set up your Stick Up Cam in the Ring app.

In the Ring app, select **Set Up a Device**.

When prompted, select **Security Cams** and follow the in-app instructions.

Try it out!

After setup, tap the Live View button in the Ring app to see live video from your Stick Up Cam.

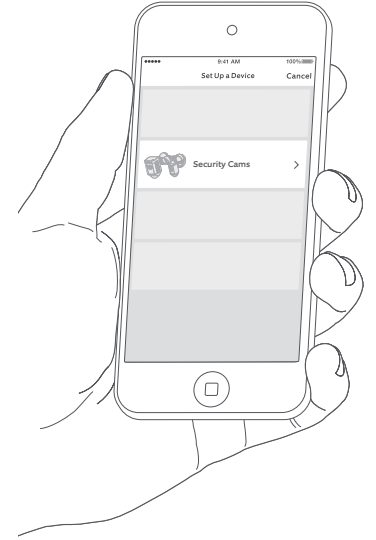

Blue light flashing?

If the light on the front of your Stick Up Cam is flashing after setup, it's updating its software.

Do not unplug your Stick Up Cam while the light is flashing!

2. Install your Stick Up Cam Wired.

How to use Stick Up Cam on a table or shelf:



Choose a location.

Stick Up Cam is happy just about anywhere, indoors or out. It comes ready to sit on a flat surface like a table or shelf, but can also be mounted to a wall or ceiling.

Choose a spot where it can provide the view you want, within reach of a power outlet or an Ethernet port with PoE.



Table or shelf



Mounted on a wall



Mounted on a ceiling

Make sure that any connected cables have been routed through the hole in the bottom cover.

Then, slide the cover into place on your Stick Up Cam. Secure the cover with the attached screw, using the star-shaped end of the screwdriver bit.

Finally, place Stick Up Cam in your chosen position. Your Stick Up Cam is now ready to protect you.

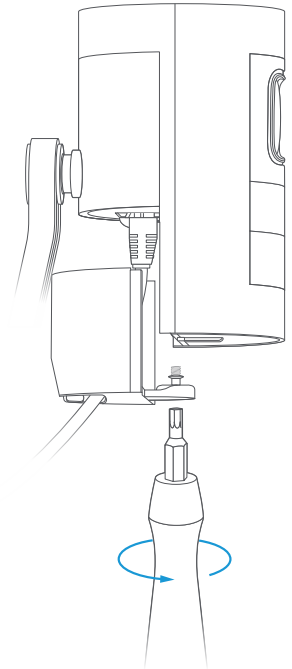

How to install Stick Up Cam on a wall:



Remove the plastic cover and rubber pad from the base.

You'll put the cover back on once you've mounted your Stick Up Cam.

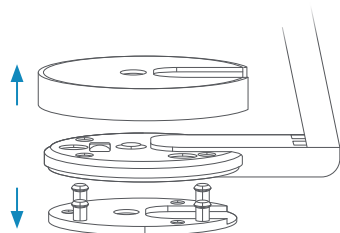

Flip the base to the rear.

The base of the stand is hinged. Before wall-mounting, flip the base down and behind your Stick Up Cam.

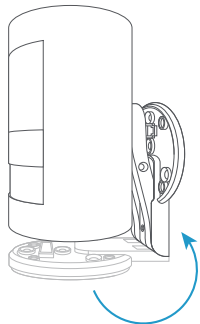
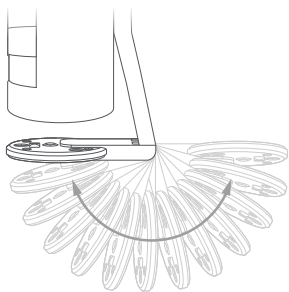

Push the rubber pad back into the base.

The rubber pad should sit between your wall and the base of your Stick Up Cam.

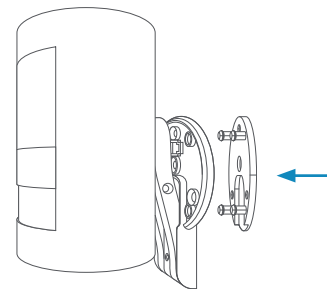

Drive the screws.

Hold the round part of the base against your wall, rubber-side down. Use the integrated level to ensure it's straight.

Then mount it with the included screws.

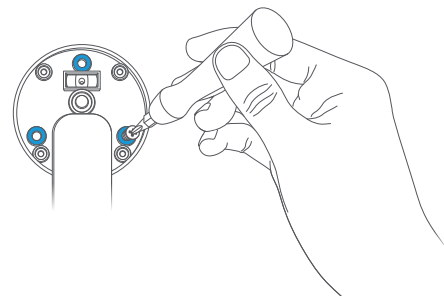

How to install Stick Up Cam on a ceiling:



Remove the plastic cover from the base.

You'll put the cover back on once you've mounted your Stick Up Cam.

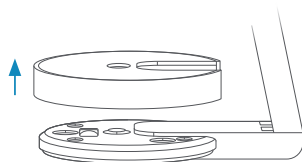

Rotate the stand above the camera:

The whole stand can rotate on its axis. Before ceiling-mounting, rotate the stand 180 degrees so the base is positioned above your Stick Up Cam.

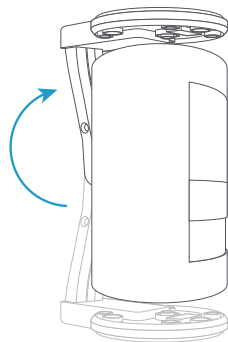
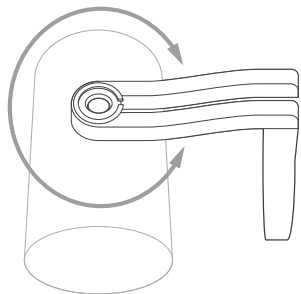

Drive the screws.

Hold the round part of the base against your ceiling, rubber-side down. Then mount it with the included screws.

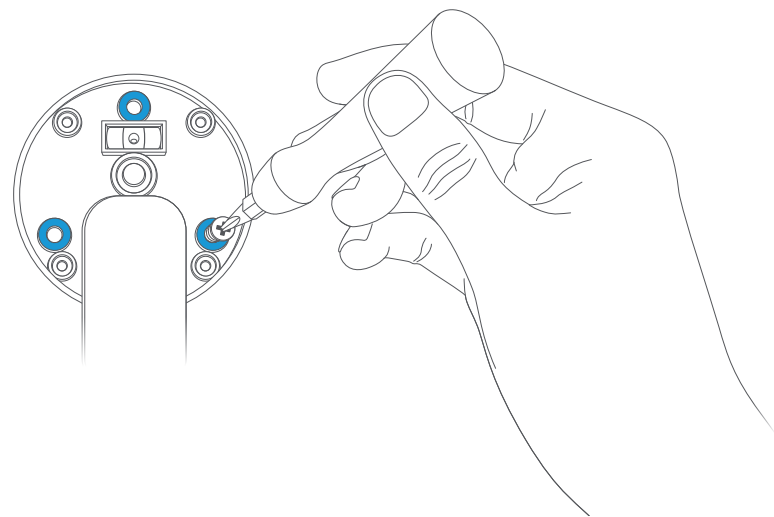

Final steps for wall or ceiling mounting:



Close it up.

Make sure that any connected cables have been routed through the hole in the bottom cover.

Then, slide the cover into place on your Stick Up Cam. Secure it with the attached screw, using the star-shaped end of the screwdriver bit.

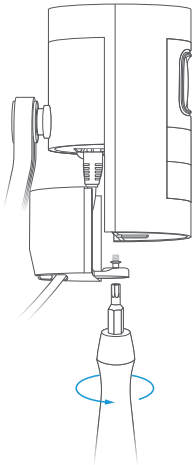

Snap the cover back onto the base.

Then, secure it with the included security screw, using the star-shaped end of the screwdriver bit.

Now your Stick Up Cam is installed and ready to protect you.

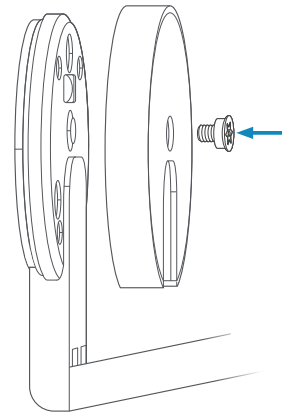

For additional help, visit: ring.com/help

Or give us a call...

US 1 800 656 1918

Canada 1 855 300 7289

Worldwide +1 310 929 7085

For a list of all our customer support numbers, visit:
ring.com/callus

To review your warranty coverage, please visit www.ring.com/warranty.

Patents: www.ring.com/patents

© 2018 Ring LLC or its affiliates.

RING, ALWAYS HOME, and all related logos are trademarks of Ring LLC or its affiliates.

Last updated: 10/18/18