



LEDR6XLV/6WYCA/6KIT

To order contact FEIT ELECTRIC COMPANY
Http: www.feit.com
Email: info@feit.com

IMPORTANT SAFETY INSTRUCTIONS AND INSTALLATION GUIDE

READ BEFORE INSTALLATION SAVE THESE INSTRUCTIONS

Please read and understand this entire manual before attempting to assemble, operate or install this product. This product must be installed in accordance with any applicable installation code(s) by a qualified electrician or person familiar with the construction and operation of the product and the hazards involved.

1. **WARNING: RISK OF SHOCK.** House electric current can cause painful shock or serious injury unless handled properly. For your safety, always remember to:
 - A. Ground the fixture to avoid potential electric shocks and to ensure reliable starting.
 - B. Double-check all connections to be sure they are tight and correct.
 - C. Wear rubber soled shoes and work on a sturdy ladder.
 2. This fixture is designed for use in a circuit protected by a fuse or circuit breaker. It is also designed to be installed in accordance with local electrical codes. If you are unsure about your wiring, consult a qualified electrician or a local electrical inspector and check your local electrical code.
 3. **WARNING: RISK OF CUTS.** Some metal parts in the fixture may have sharp edges. To prevent cuts and scrapes, wear gloves when handling the parts.
 4. Account for small parts and destroy packing material, as these may be hazardous to children.
 5. Risk of Fire - MINIMUM 90°C SUPPLY CONDUCTORS. If uncertain, consult an electrician.
 6. This device is not intended for use with emergency exits.
 7. Risk of pinching - Do not place hands under springs during removal of the downlight.
- VAPOR BARRIER MUST BE SUITABLE FOR 90 °C.
 - FOR USE IN NON-FIRE-RATED INSTALLATIONS ONLY.

Product Specifications

- 120VAC, 60Hz, 145 MAX Watts
- Dimmable
- Suitable for Wet Locations

NOTICE:

- All electrical connections must be in accordance with local and National Electrical Code (N.E.C) standards. If you are unfamiliar with proper electrical wiring connections, obtain the services of a qualified electrician.
- Remove the fixture and the mounting package from the box to make sure that no parts are missing by referencing the illustrations on the installation instructions.



CAUTION: Turn off the main power at the circuit breaker before installing the fixture in order to prevent possible shock.

Supplier's Declaration of Conformity:
47 CFR § 2.1077 Compliance Information
Responsible Party:
Feit Electric Company
4901 Gregg Road,
Pico Rivera, CA 90660, USA
Unique Identifier:
FEIT ITEM # LEDR6XLV/6WYCA/6KIT

This device complies with part 15 of the FCC Rules. Operation is subject to the following two conditions: (1) This device may not cause harmful interference, and (2) this device must accept any interference received, including interference that may cause undesired operation. Note: This equipment has been tested and found to comply with the limits for a Class B digital device, pursuant to part 15 of the FCC Rules. These limits are designed to provide reasonable protection against harmful interference in a residential installation. This equipment generates, uses and can radiate radio frequency energy and, if not installed and used in accordance with the instructions, may cause harmful interference to radio communications. However, there is no guarantee that interference will not occur in a particular installation. If this equipment does cause harmful interference to radio or television reception, which can be determined by turning the equipment off and on, the user is encouraged to try to correct the interference by one or more of the following measures: Reorient or relocate the receiving antenna. Increase the separation between the equipment and receiver. Connect the equipment into an outlet on a circuit different from that to which the receiver is connected. Consult the dealer or an experienced radio/TV technician for help. Any changes or modifications not expressly approved by the manufacturer could void the user's authority to operate the equipment.

WARRANTY

This product is warranted to be free from defects in workmanship and materials for up to five years from date of purchase. If the product fails within the warranty period, please contact Feit Electric at info@feit.com, visit feit.com/contact-us for instructions on replacement or refund. REPLACEMENT OR REFUND IS YOUR SOLE REMEDY. EXCEPT TO THE EXTENT PROHIBITED BY APPLICABLE LAW, ANY IMPLIED WARRANTIES ARE LIMITED IN DURATION TO THE DURATION OF THIS WARRANTY. LIABILITY FOR INCIDENTAL OR CONSEQUENTIAL DAMAGES IS HEREBY EXPRESSLY EXCLUDED. Some states and provinces do not allow the exclusion of incidental or consequential damages, so the above limitation or exclusion may not apply to you. This warranty gives you specific legal rights, and you may also have other rights which vary from state to state or province to province.

PACKAGE CONTENTS

Before beginning installation of this product, make sure all parts are present. Compare parts with package contents list and diagram. If any part is missing or damaged, do not attempt to assemble, install or operate this product.

Tools Required (Not Included)

- Screw driver
- Recessed lighting hole saw (recommended)
- Scissors
- Pencil

Package Components

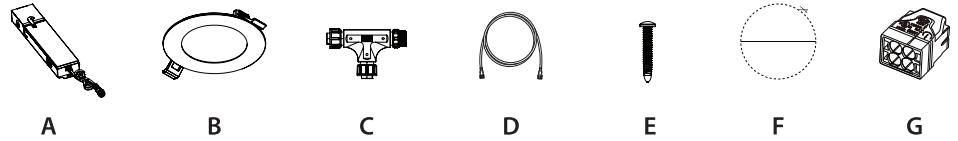

	COMPONENTS INCLUDED
A	(1) POWER SUPPLY BOX
B	(6) LED RECESSED DOWNLIGHT
C	(5) T-CONNECTORS
D	(5) 6FT LOW VOLTAGE CABLE
E	(2) SCREWS (M4 & 25MM)
F	(1) CUT OUT TEMPLATE
G	(3) QUICK CONNECTORS
H	(1) INSTRUCTION MANUAL

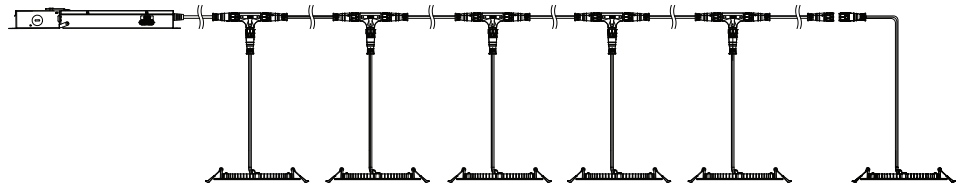

PRODUCT ELECTRICAL RATINGS

The foam insert between the trim and ceiling of this panel will create an air tight seal and is required for the ASTM Air Tight Certification. Suitable for Type IC.

LIGHTING DISTRIBUTION

Distance	Center Beam (Foot candles)	Beam Diameter
3 ft.	42	7.2 ft.
5 ft.	15	12 ft.
8 ft.	5.9	19 ft.
15 ft.	1.7	36 ft.
Beam Angle = 100°		

CHOOSE A WHITE COLOR SETTING

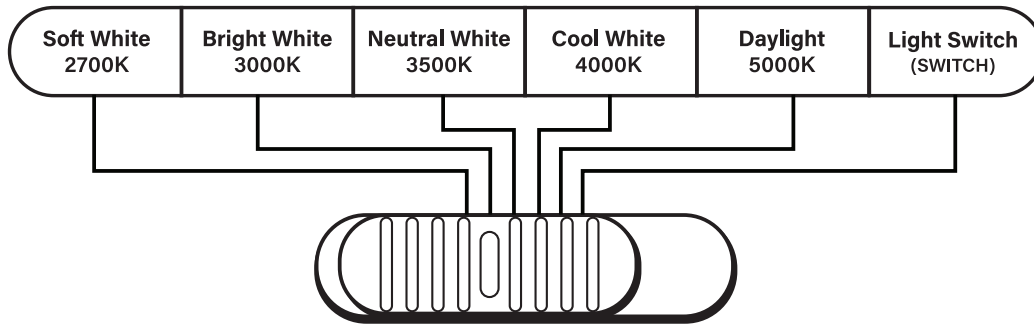

NOTICE: The toggle switch is located on the power supply box.

PICK YOUR FAVORITE LIGHT COLOR BEFORE INSTALLING

- You can lock in one white color temperature or change among multiple white color temperatures. The unit will memorize the last white color temperature and default to it automatically.
- When the slide switch is set to SW (Soft White), the white color temperature is set at 2700K.
- When the slide switch is set to BW (Bright White), the white color temperature is set at 3000K.
- When the slide switch is set to NW (Neutral White), the white color temperature is set at 3500K.
- When the slide switch is set to CW (Cool White), the white color temperature is set at 4000K.
- When the slide switch is set to DL (Daylight), the white color temperature is set at 5000K.

ADJUST YOUR LIGHT COLOR ANYTIME WITH A REGULAR WALL LIGHT SWITCH

- Set the slide switch on the power supply box to SWITCH.
- Toggle your light switch ON and OFF within 0.5-2 seconds to cycle through the five different white color temperatures.
- If the fixture is left OFF for over 10 seconds then turned ON, the fixture remembers the last white color temperature selected and displays that color when turned on again.
- The reset function is used when using multiple color selectable lighting products operating from the same light switch. In the event that multiple fixtures are not displaying the same color at the same time, the fixtures must be RESET using your existing light switch. Simply toggle the wall switch ON and OFF 7 times, leaving it in the ON position for 1 second intervals (e.g., with the fixture in the ON position, toggle the wall switch OFF then ON, leaving it ON for 1 second, then OFF then ON, leaving it ON for 1 second (repeat 7 times).

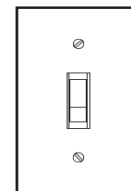

PRE-INSTALLATION REVIEW

- Turn the power OFF from the breaker panel before starting installation.
- Locate a suitable location for the fixture and cut the correctly sized hole in the drywall or ceiling tile (for a suspended T-Bar type ceiling) – refer to Hole Cut Out Template for appropriate size.
- Know the location of your joist before making any cuts.
- Use the slide switch to choose a preferred color temperature before installing (2700K, 3000K, 3500K, 4000K, 5000K)

INSTALLATION INSTRUCTIONS FOR RECESSED HOUSING

1 Determine how many downlights will be installed with the Power Supply (max. 145W). Carefully measure where each fixture will be installed. Use the provided cutout template to mark your hole location.

2 Cut a 6 3/8 in. hole in the ceiling as round as possible using a recessed lighting hole saw (and the provided cutout template). Make sure the opening is not larger than the outer trim of light.

NOTE: Before cutting, ensure that the hole does not impinge on joists, pipe work, cable or other building services.

Recessed lighting hole saw

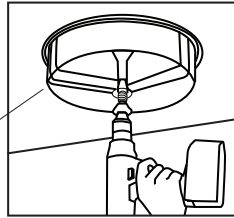

3 Gently extract the knockout from the Power Supply Box (A) using a screwdriver or punch driver.

NOTE: For easier installation, separate the power supply box and downlight by disconnecting the tethered connectors.

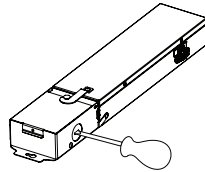

4 Open the cover of the Power Supply Box (A). Feed the supply wire into the knockout hole using a 3/8 in. clamp connector (not included). Using Quick Connectors (G), connect the 120V line (black) wire to the black wire, connect the neutral (white) wire to the white wire, and connect the ground (green) wire to the green wire. This power supply box needs to be grounded. Wires inserted into the quick connectors must meet the *Wire Gauge and Strip Length Requirements.

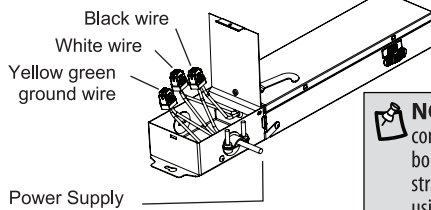

NOTE: For the best connection, use solid wire or tin bonded stranded wire. If using stranded wire, we recommend using wire nuts (not included).

5 After inserting the supply wire into the quick connectors, verify the connection by following these simple tests:

- Hold the quick connector with one hand and with the other hand pull at the connected wires to ensure proper wire connection.
- Ensure a sufficient amount of wire is visible through the clear shell for visual verification.

6 Insert the Power Supply Box (A) into the ceiling opening and secure it with the latch. Mount to structure using the provided screws (E).

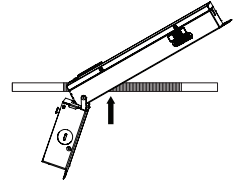

7 Connect the T-Connector (C) to the low voltage cable originating from the Power Supply Box (A). Then attached the LED Downlight (B) to the T-Connector (C). If adding more downlights, attached a Low Voltage Cable (D) to the end of the T-connector.

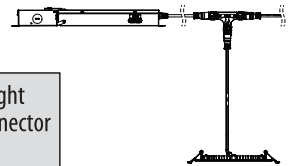

NOTE: The last connected downlight will use the Single Connector. T-Connector must not be the last connector.

8 Direct the Low Voltage Cable (D) towards other downlight spots and ensure to leave enough slack through each opening for ease of fixture connection, approximately 6 feet apart. Place the excess cable in the ceiling securely.

NOTE: It's safe for LED downlight to come into direct contact with insulation as they are specifically rated for this kind of contact. DO NOT CUT THE LOW VOLTAGE CABLE.

9 Repeat steps 7 and 8 for any additional downlights linked to the system.

10 Before restoring power at the breaker, make sure all LED downlights are connected. Hold the spring clips against the fixture and gently guide into the ceiling until the clips snap into place. The fixture should be flush with the ceiling.

NOTE: Ceiling thickness must be 1/2" to 3/4".

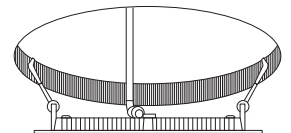

11 Restore the power at the breaker panel.

* WIRE GAUGE AND STRIP LENGTH REQUIREMENTS

Wire Type	Wire Range	Strip Length
Solid wire	14-18 AWG	0.43 - 0.50 in.
Tin bonded stranded wire	14-18 AWG	0.43 - 0.50 in.

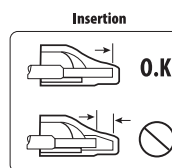
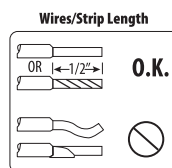

NOTE: If the jacket of the cable is not in the quick connector ensure the strip length is correct and/or verify the wire is fully inserted.

CUTOUT TEMPLATE - For a 6 3/8 in. hole.

