

This fixture will fit a 4" Pancake Box, 4/O J-Box and Non-metallic 4" J-Box

WARNING:

- Risk of electric shock. Disconnect power at fuse or circuit breaker before installing or servicing.
- For use in operating environments between 20°C - 30°C (68°F and 86°F)
- No user serviceable parts inside. To avoid electric shock do not disassemble product.

ATTENTION:

Turn power off before inspection, installation, or removal.
Use only on 120VAC, 60Hz circuits.

SAFETY INSTRUCTIONS:

1. Do not use outdoors.
2. Equipment should be mounted securely in locations and at heights where it will not be readily subjected to tampering by unauthorized personnel.
3. Do not mount near gas or electric heaters.
4. Cap unused wires with enclosed wire nuts or other approved method.
5. Do not use this equipment for anything other than its intended use.
6. The use of accessory equipment not recommended by the manufacturer will void product listing and warranty and may cause an unsafe condition.
7. Use caution when servicing batteries.
8. Any service on this equipment should be performed by qualified personnel only.
9. Make sure wire terminations are secure and leads are properly tucked in appropriate wire channels.

CONSULT A QUALIFIED ELECTRICIAN BEFORE INSTALLING



What's In The Box

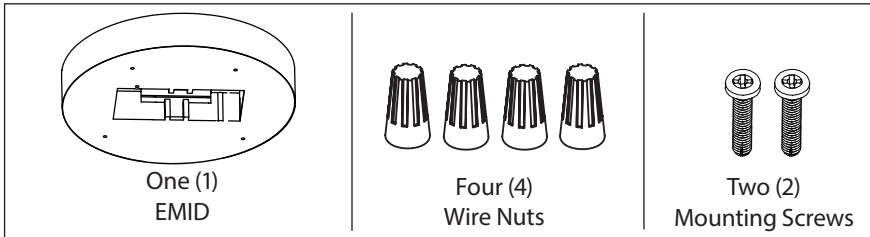

Tools Needed

This EMID Surface Mount Emergency Battery Pack requires very few tools for installation. A screwdriver and a pair of wire cutters will help to install the downlight to a Junction Box.

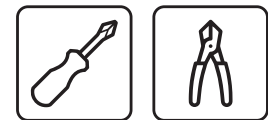

Installation



Make sure all power is turned off before beginning installation

- 1 Make wiring of the EMID to the building power connections as shown.

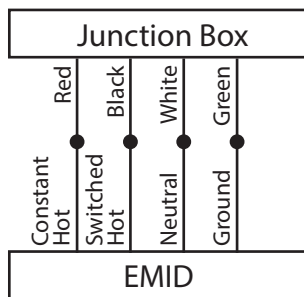

- 2 Carefully tuck the wires into the J-Box and attached the battery pack to the junction box using the included screws.

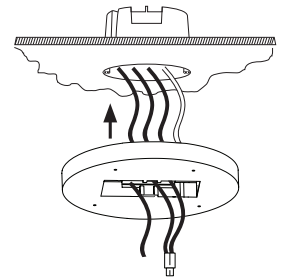

- 3 Mount the luminaire mounting bracket to the battery pack with the 2 (two) mounting screws included with the luminaire. The mounting bracket should be mounted at an angle (as shown) so that the fixture clips do not collide with the battery pack.

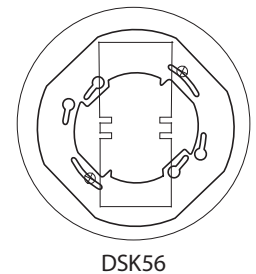
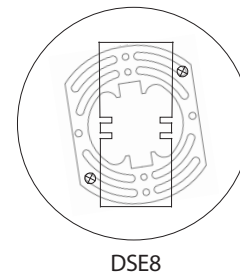
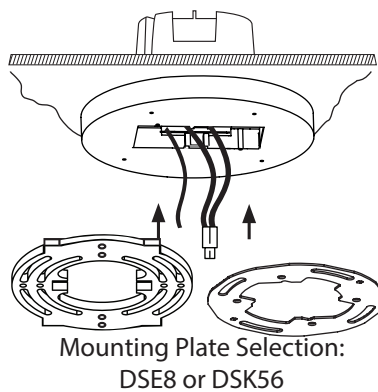

Installation continued



Make sure all power is turned off before beginning installation

- 4 Connect fixture wiring to EMID wiring. Insert tinned Black and White wires of fixture into end of luminaire disconnect. Connect ground wires with wire nut.

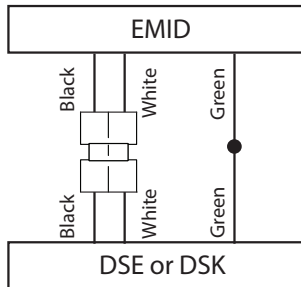

- 4 Carefully tuck the wires into the J-Box, align the spring clips on the fixture to the bracket holes and push the fixture flush to the ceiling, snapping the clips into the bracket.

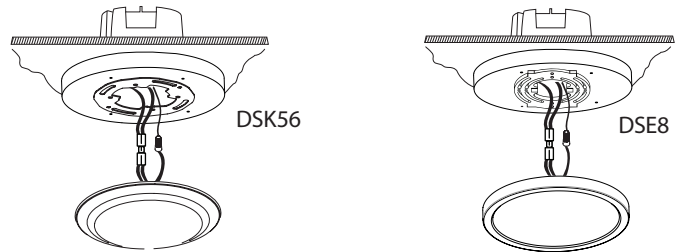

NICOR LIMITED WARRANTY - EMERGENCY BATTERY PACKS. Each NICOR product will be free from defect in materials and workmanship for a period of five (5) years from the date of delivery to the end-user. Powder Coat paint finish on products, other than natural aluminum or brass, will not exhibit cracking, peeling, excessive fading, or corrosion during the warranty period. Exceptions apply as defined in each NICOR product's specification sheets, which are incorporated by reference herein. Warranty does not cover improper installation, operation, alterations, power surges, overheating due to external conditions, or acts of nature including but not limited to lightning strikes.

POLE WARRANTY. Each NICOR Pole will be free from defect in materials and workmanship for a period of (1) year from the date of delivery to the end-user. Powder Coat paint finish on products, other than natural aluminum or brass, will not exhibit cracking, peeling, excessive fading, or corrosion during the warranty period. Poles must be installed by a properly insured and licensed contractor, using the supplied anchor bolts and mounting templates. Using a pole product in any manner other than as disclosed in the Application Specification automatically voids the warranty and may cause failure resulting in injury, death, or significant property damage.

ALL NICOR WARRANTIES APPLY ONLY TO NICOR PRODUCTS THAT HAVE BEEN PURCHASED FROM AN AUTHORIZED NICOR DISTRIBUTOR; WHO PURCHASED THE PRODUCT DIRECTLY FROM NICOR; THE PRODUCT WAS NEW AND IN AN UNOPENED NICOR PACKAGE AT THE TIME OF INSTALLATION; AND WAS INSTALLED BY A LICENSED ELECTRICIAN OR UNDER THE SUPERVISION OF A LICENSED ELECTRICIAN.

This device complies with part 15 of the FCC Rules. Operation is subject to the following two conditions: (1) This device may not cause harmful interference, and (2) this device must accept any interference received, including interference that may cause undesired operation.

NOTE: This equipment has been tested and found to comply with the limits for a Class B digital device, pursuant to part 15 of the FCC Rules. These limits are designed to provide reasonable protection against harmful interference in a residential installation. This equipment generates, uses and can radiate radio frequency energy and, if not installed and used in accordance with the instructions, may cause harmful interference to radio communications. However, there is no guarantee that interference will not occur in a particular installation. If this equipment does cause harmful interference to radio or television reception, which can be determined by turning the equipment off and on, the user is encouraged to try to correct the interference by one or more of the following measures:

- Reorient or relocate the receiving antenna.
- Increase the separation between the equipment and receiver.
- Connect the equipment into an outlet on a circuit different from that to which the receiver is connected.
- Consult the dealer or an experienced radio/TV technician for help