

homestyles

20 05320 00SC

Sofa Console

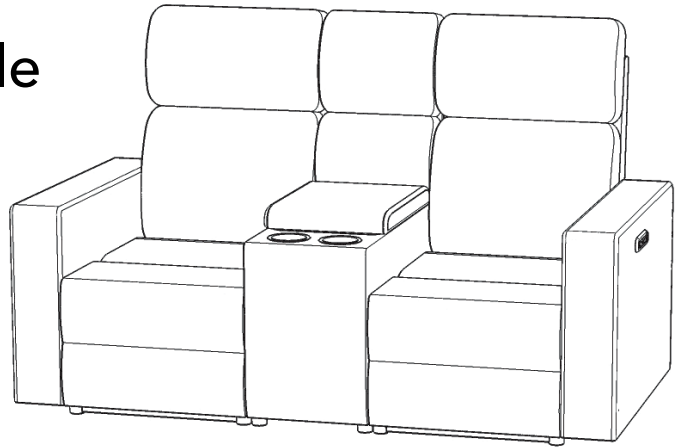

IMPORTANT

Carefully remove all the parts from the carton and place them individually on a soft cloth to prevent scratches or other damage.

Carefully and strictly follow these assembly instructions to ensure a completed product as designed.

Do not use power tools above 8 volts to assemble.

Part List

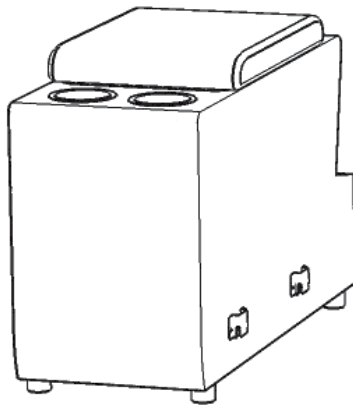

E.
Console
1 pc.

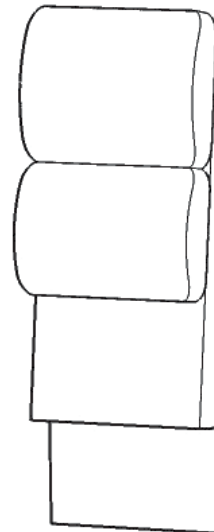

F.
Back
1 pc.

Cartons 20 05320 00LS and 20 05320 00RS are also needed for assembly.

32166 TWSB

Home Styles Customer Service: www.homestyles-furniture.com,
servicedesk@homestyles-furniture.com, 888-680-7460, 877-831-0319

Assembly Instructions 2/6

STEP 1

Attach plug of Back (B) to plug of Seat (A), then flip the lock. (See Figures 1 and 2)

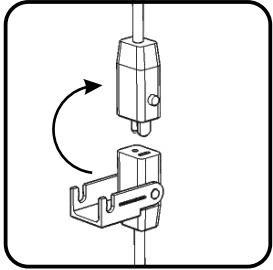

Figure 1

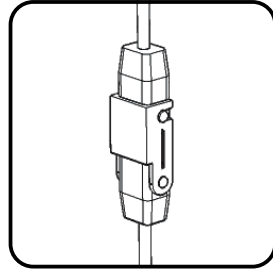
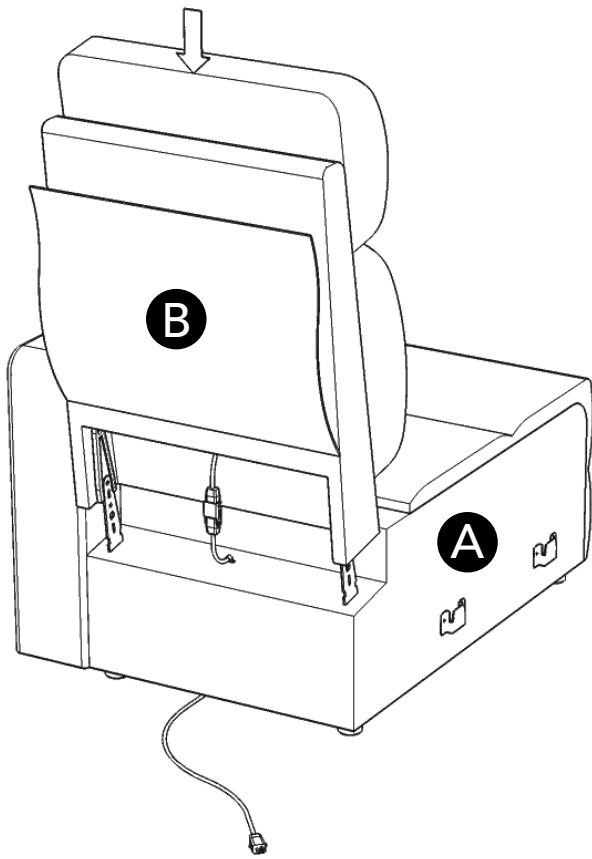
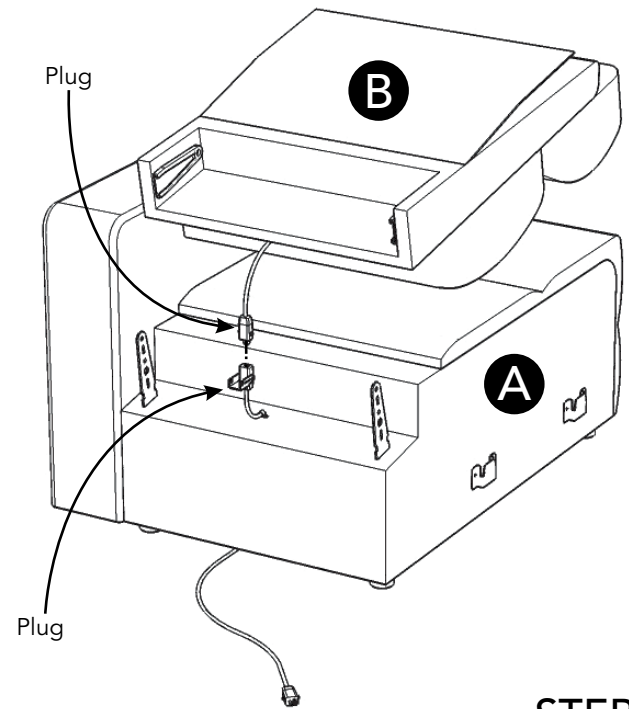

Figure 2



STEP 2

Attach Back (B) to Seat (A).
(See Figure 3)

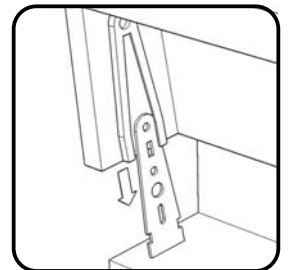
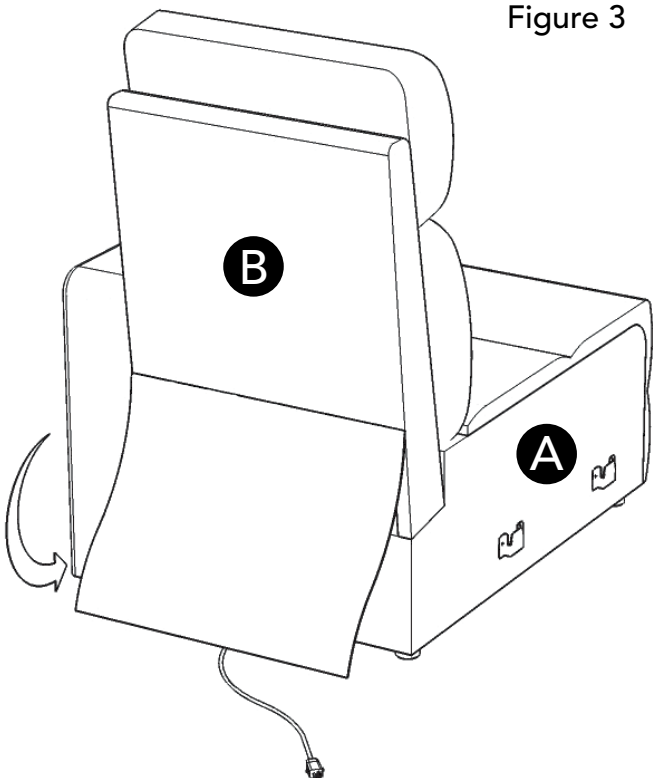

Figure 3



STEP 3

Attach back flap of Back (B) to back of Seat (A).

Assembly Instructions 3/6

STEP 4

Attach plug of Back (D) to plug of Seat (C), then flip the lock.

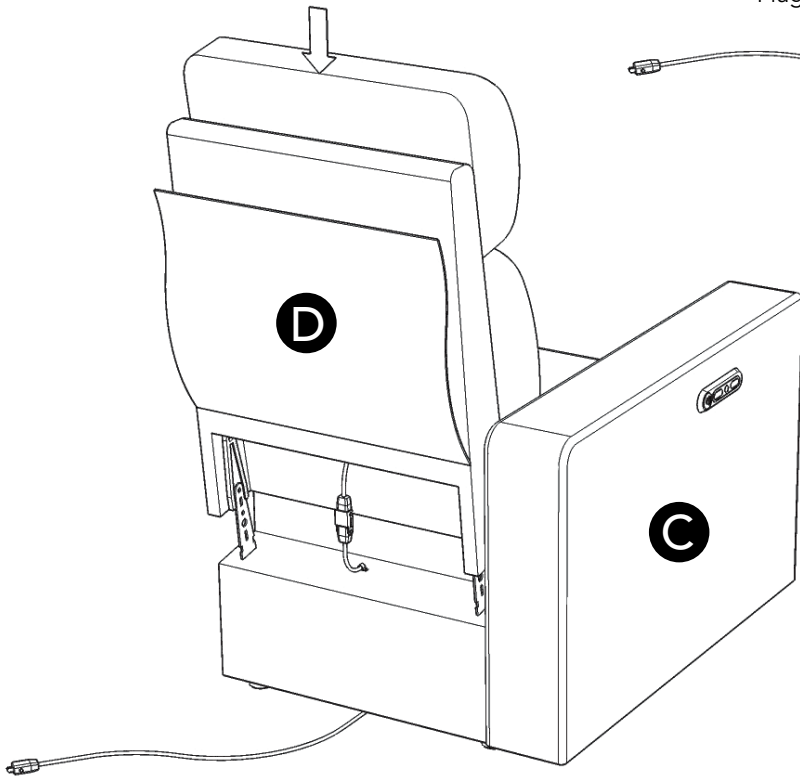
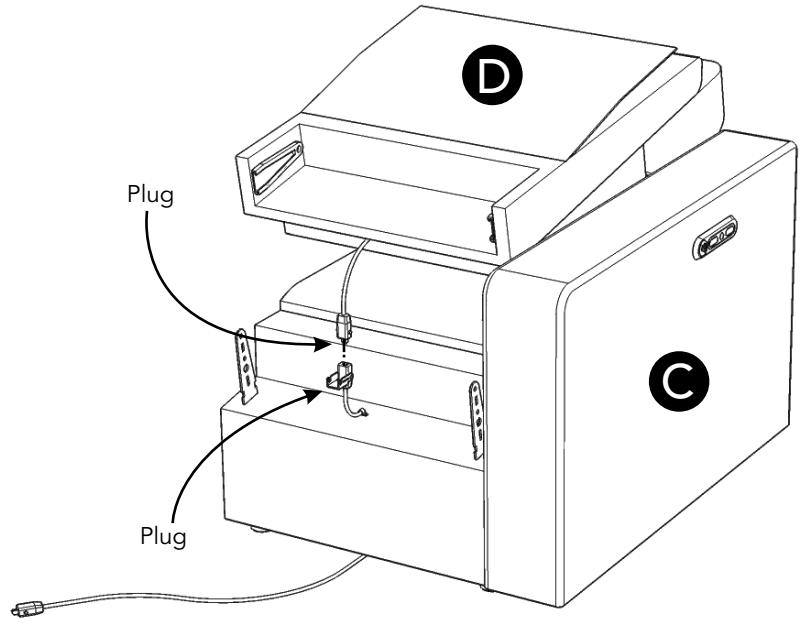

STEP 5

Attach Back (D) to Seat (C).

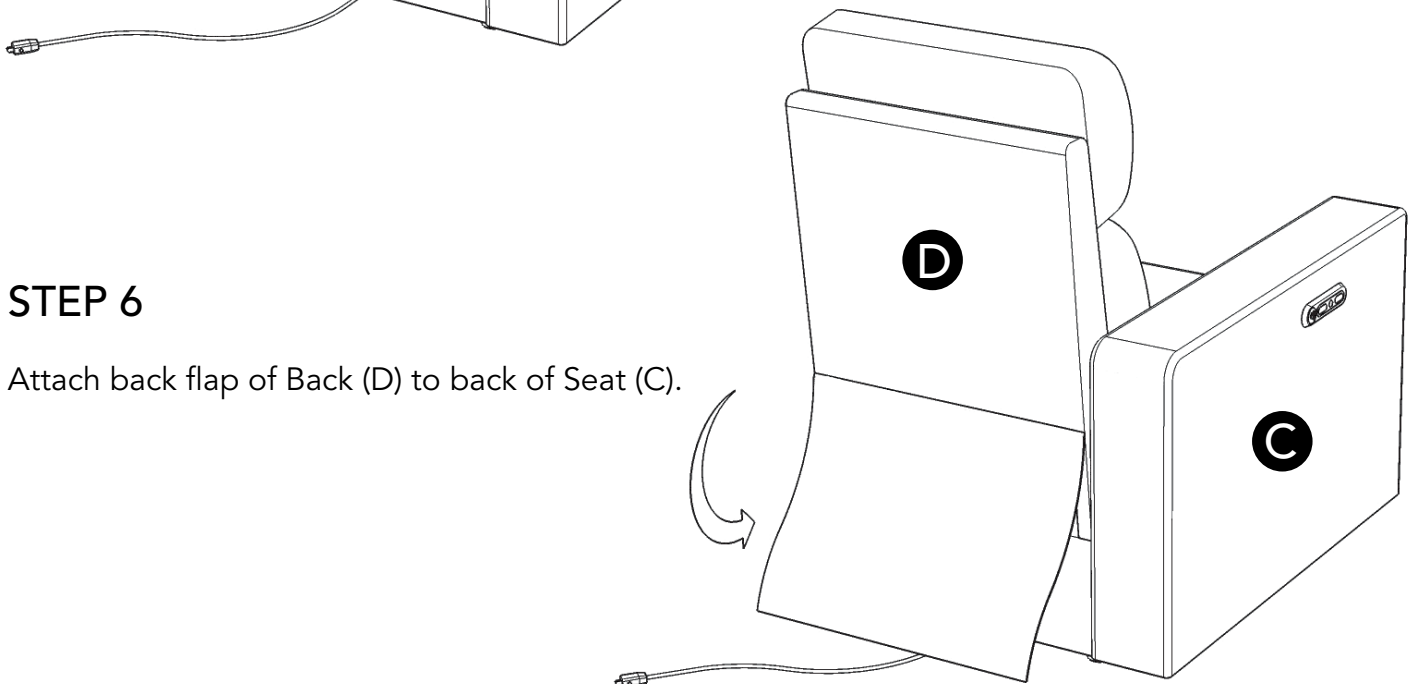

STEP 6

Attach back flap of Back (D) to back of Seat (C).

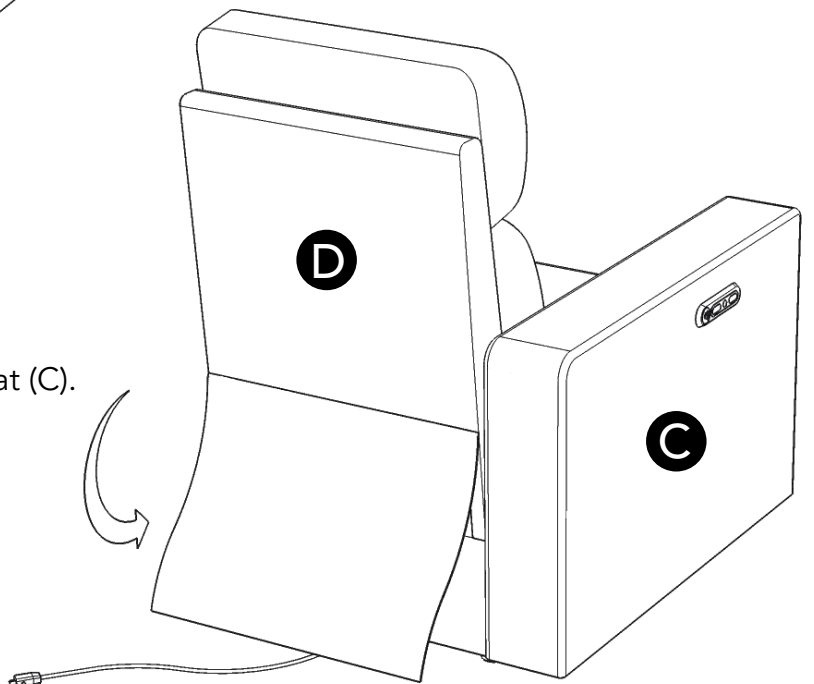

STEP 7

Attach Back (F) to Console (E).

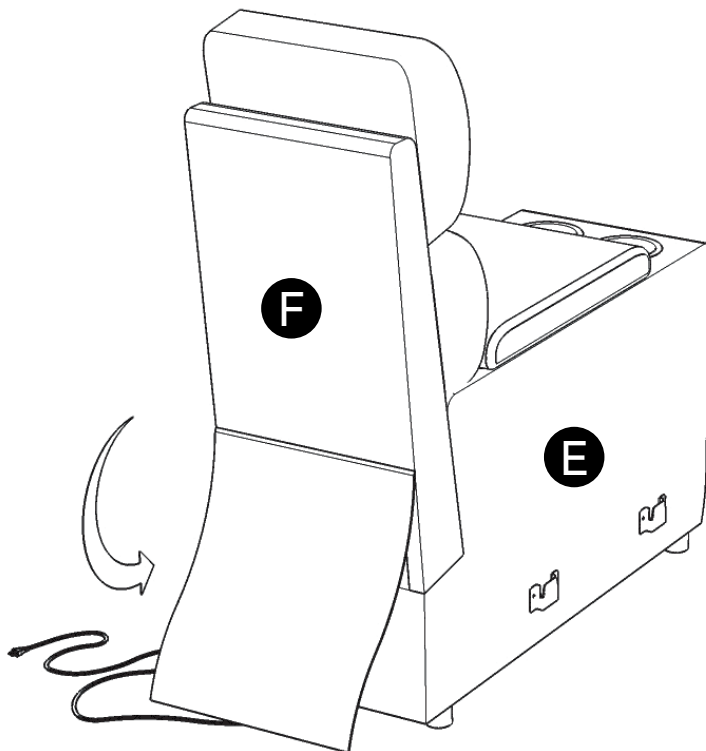
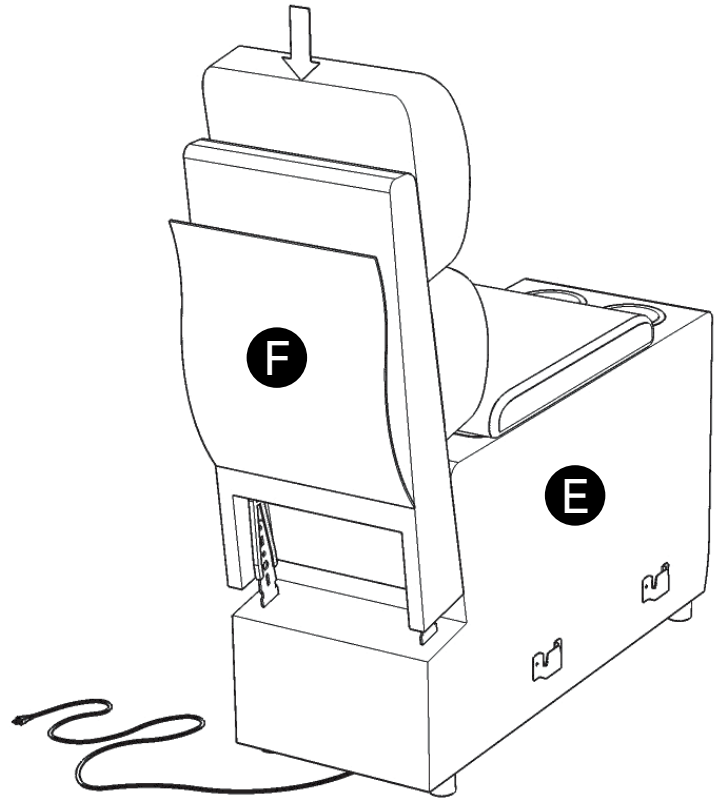

STEP 8

Attach back flap of Back (F) to back of Console (E).

STEP 9

Attach sofa console to right seat.
(See Figure 4)

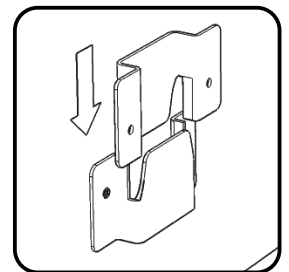
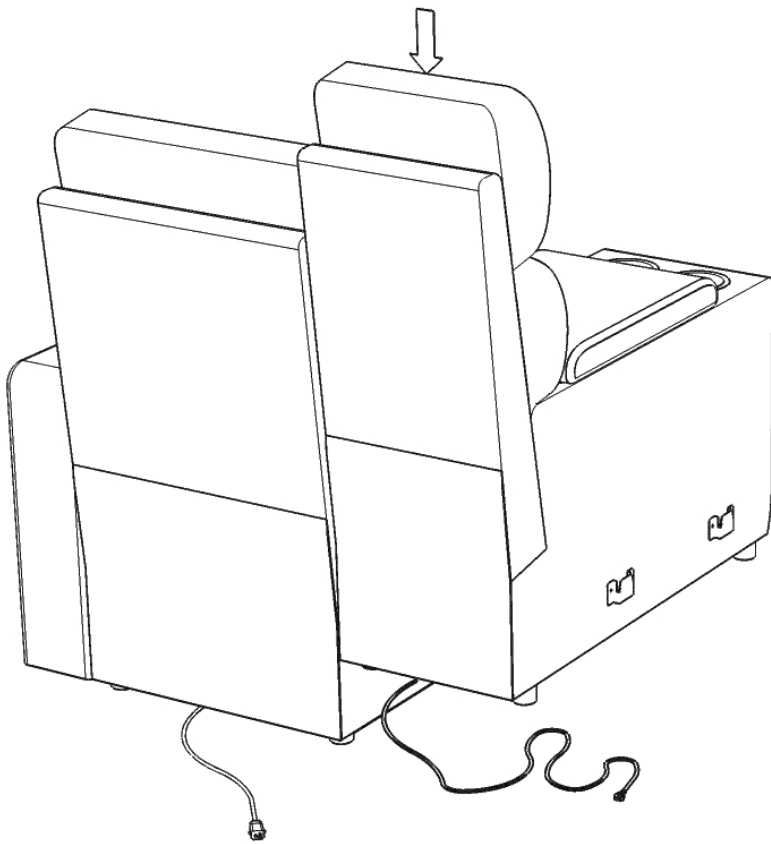
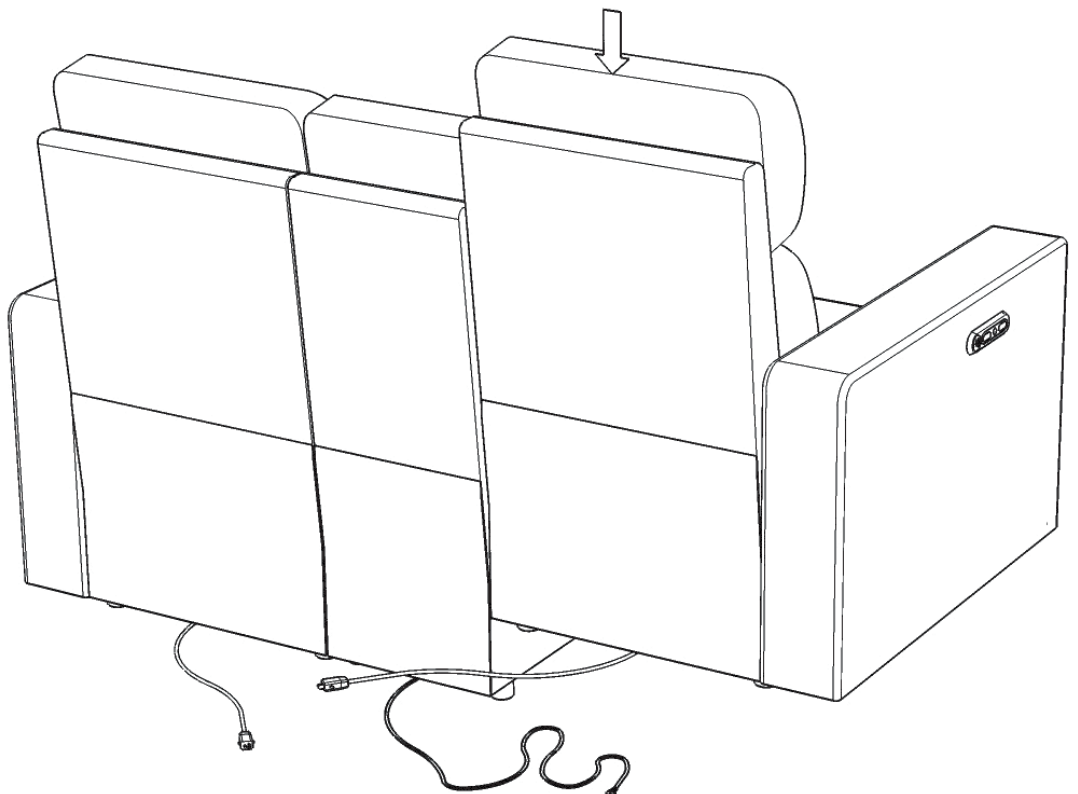
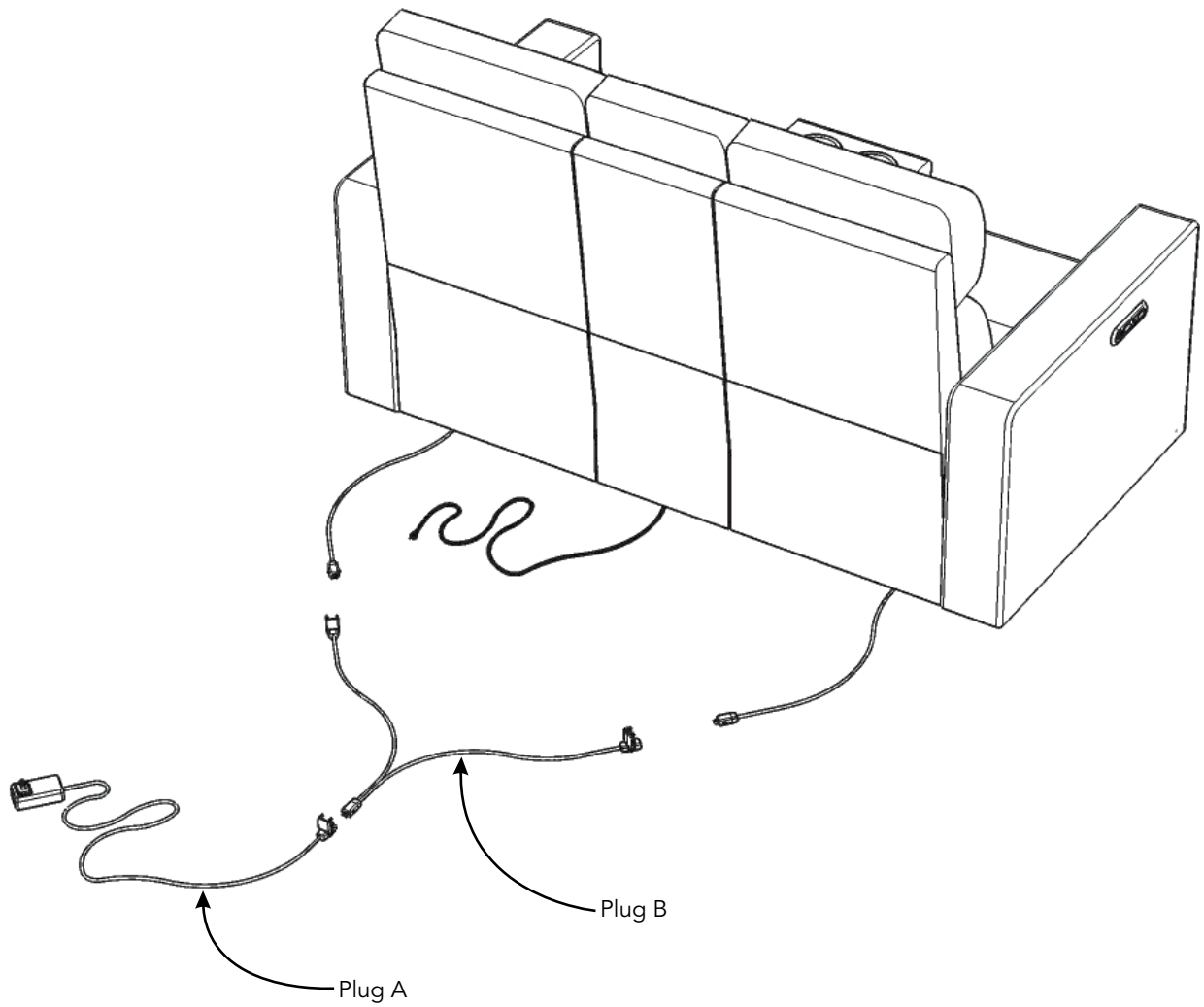

Figure 4

STEP 10

Attach left seat to unit.





STEP 11

Attach Plug B to plugs of unit, then flip the locks. (See Figures 5 and 6)

Attach Plug A to Plug B, then flip the lock.

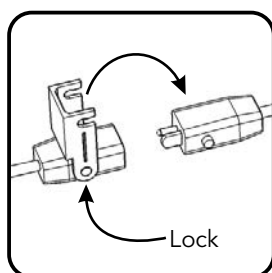

Figure 5

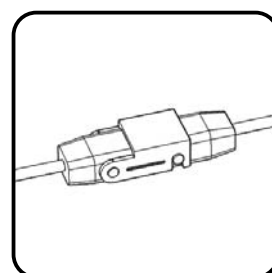

Figure 6

CARE INSTRUCTIONS

NEVER

allow liquids to remain on furniture.
Absorption causes parts to warp
and split and finishes to delaminate.

NEVER

use glass cleaners on
finished furniture. Ammonia
chemically attacks the finish.



Do not use power tools
above 8 volts to assemble.
**PREVENT
CRACKING**



Do not place
in direct sunlight.
**PREVENT
FADING**



Do not write
directly on surface.
**PREVENT
MARKING**



Do not place hot
objects on surface.
**PREVENT
FINISH DAMAGE**

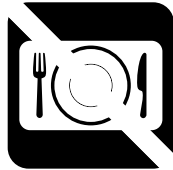

Do not use rubber
based placemats.
**PREVENT
DISCOLORING**



Do not use commercial
waxes and polishes.
**PREVENT
YELLOWING**

CLEAN

with a soft cloth moistened
in lukewarm soap and water.
Buff with a dry clean cloth.



Home Styles will provide replacements free of charge for missing or damaged hardware or parts within 30 days of purchase. Digital images of the defective parts may be required. If the product was not purchased from an authorized retail affiliate, Home Styles is under no obligation to provide replacement parts. Parts are not available for fully assembled items nor are parts available for sale. Replacements for missing or damaged hardware or parts may be requested at:

www.homestyles-furniture.com/customer-service/replacement-parts

Home Styles Customer Service: www.homestyles-furniture.com,
servicedesk@homestyles-furniture.com, 888-680-7460, 877-831-0319