

homestyles[®]

5002-941

Kitchen Island

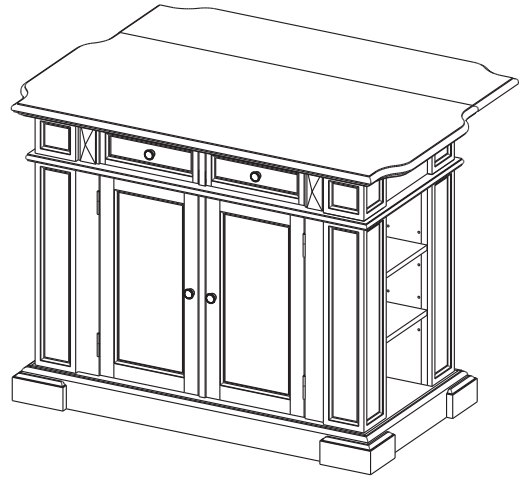

IMPORTANT

Carefully remove all the parts from the carton and place them individually on a soft cloth to prevent scratches or other damage.

Carefully and strictly follow these assembly instructions to ensure a completed product as designed.

Do not use power tools above 8 volts to assemble.

Part List

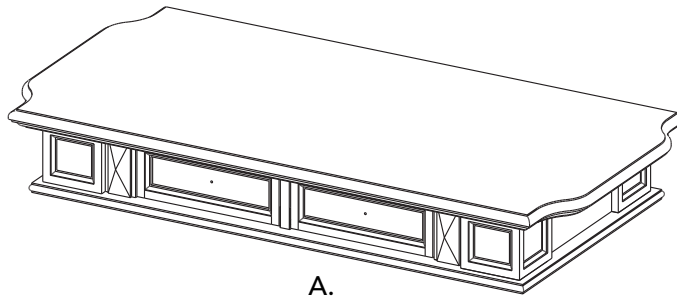

A.
Top Unit
1 pc.

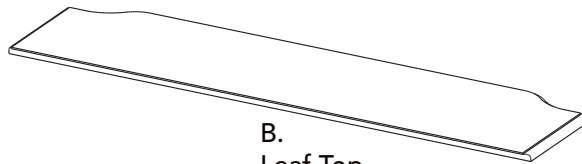

B.
Leaf Top
1 pc.

For assembly see instructions in carton 5002-943.

homestyles Customer Service: www.homestylesfurniture.com,
servicedesk@homestylesfurniture.com, 888-680-7460

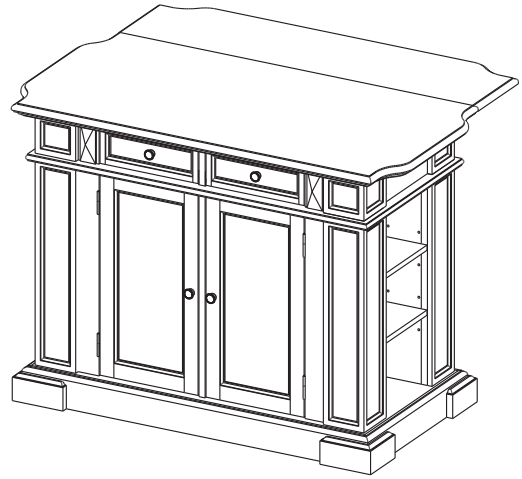

IMPORTANT

Carefully remove all the parts from the carton and place them individually on a soft cloth to prevent scratches or other damage.

Carefully and strictly follow these assembly instructions to ensure a completed product as designed.

Do not use power tools above 8 volts to assemble.

Part List



C.
Back Rail
2 pcs.

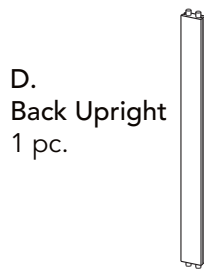

D.
Back Upright
1 pc.

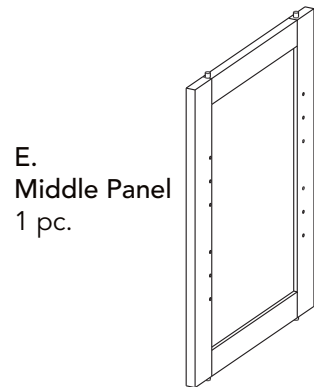

E.
Middle Panel
1 pc.

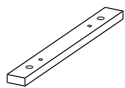

F.
Rail
2 pcs.

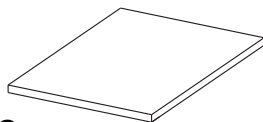

G.
Shelf
4 pcs.

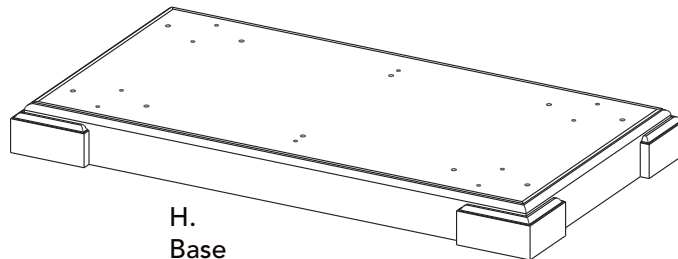

H.
Base
1 pc.

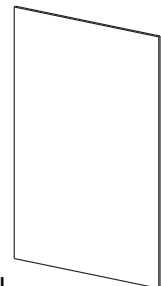

N.
Back Panel
2 pcs.

Hardware List

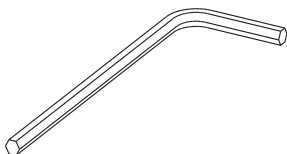

Hex Wrench
1 pc.



Cam Lock
4 pcs. (+2 extra)



Cam Lock Screw
4 pcs. (+1 extra)



M3.5x16
Wood Screw
9 pcs. (+1 extra)



M4x25
Machine Screw
4 pcs.

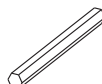

Small Hex Wrench
1 pc.

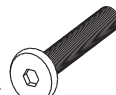

M6x35
Head Cap Bolt
18 pcs. (+1 extra)



Adjustable Pin
32 pcs. (+1 extra)



Knob
4 pcs.

For assembly see instructions in carton 5002-943.

homestyles[®]

5002-943

Kitchen Island

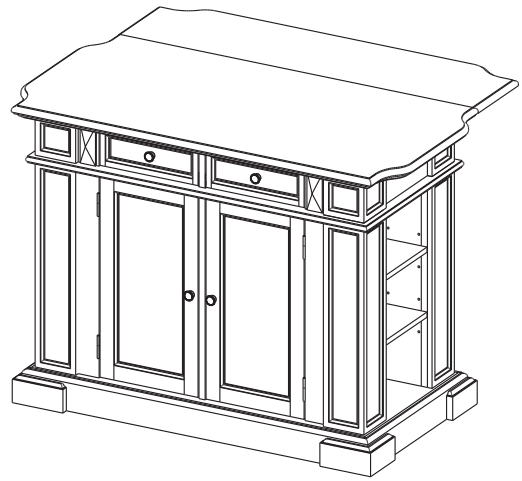

IMPORTANT

Carefully remove all the parts from the carton and place them individually on a soft cloth to prevent scratches or other damage.

Carefully and strictly follow these assembly instructions to ensure a completed product as designed.

Do not use power tools above 8 volts to assemble.

Part List

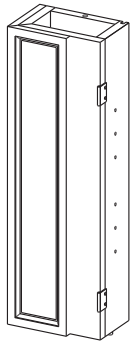

I.
Post
1 pc.

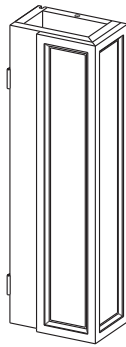

J.
Post
1 pc.

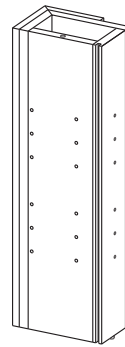

K.
Post
1 pc.

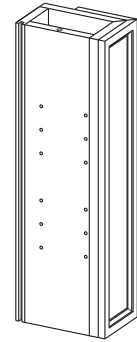

L.
Post
1 pc.

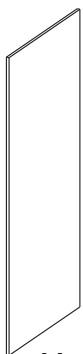

M.
Side Panel
2 pcs.

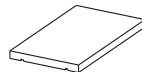

O.
Shelf
4 pcs.

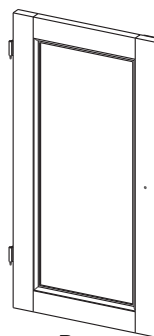

P.
Door
1 pc.

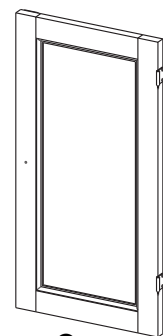

Q.
Door
1 pc.

Cartons 5002-941, 5002-942 are also needed for assembly.

Tool(s) required for assembly: Phillips screwdriver, Level

homestyles Customer Service: www.homestylesfurniture.com,
servicedesk@homestylesfurniture.com, 888-680-7460

Assembly Instructions 2/6

IMPORTANT

- Use a soft cloth between these parts and the floor.
- Do not use power tools above 8 volts to assemble.
- Do not tighten all the bolts until each part is properly assembled.
- The unit must be level to work properly. Use the included adjustable levelers to level.
- Keep Hex Wrench as the bolts may need to be tightened in the future.

STEP 1

Insert Cam Lock Screws into pre-drilled holes in Posts (K) and (L), then tighten. (See Figure 1)

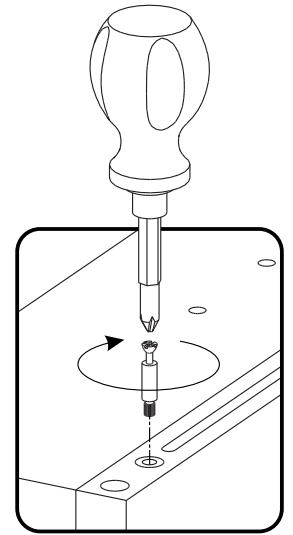
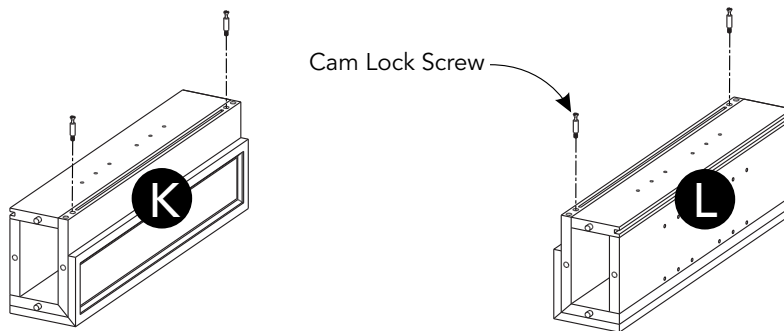
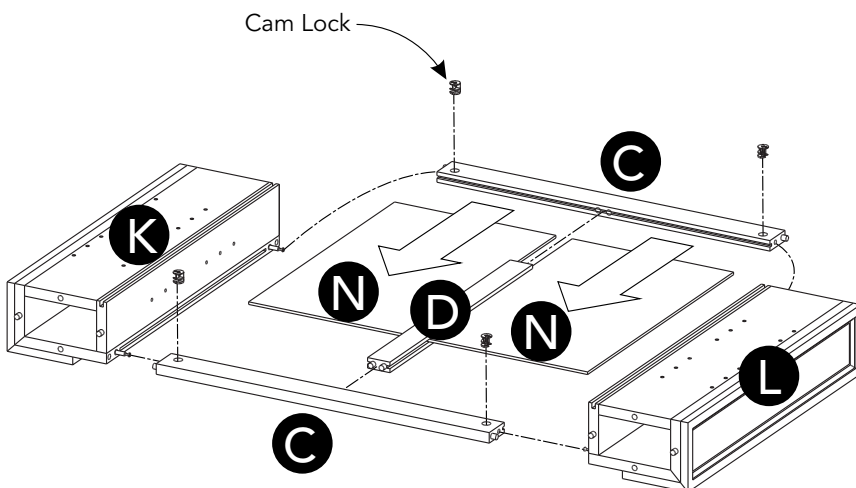

Figure 1



STEP 2

Attach Back Rail (C) to Post (K) with Cam Lock. (See Figure 2)

Attach Back Upright (D) to Back Rail (C).

Slide Back Panels (N) into position.

Attach Back Rail (C) to unit with Cam Lock.

Attach Post (L) to unit with Cam Locks.

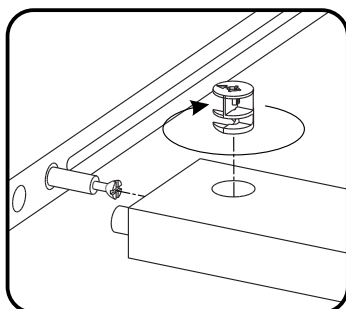

Figure 2

Assembly Instructions 3/6

STEP 3

Attach unit and Middle Panel (E) to Base (H) with Head Cap Bolts. (See Figure 3)

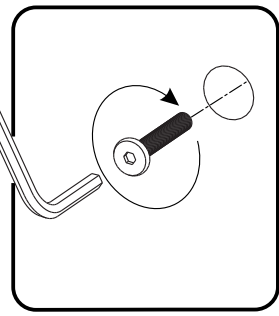
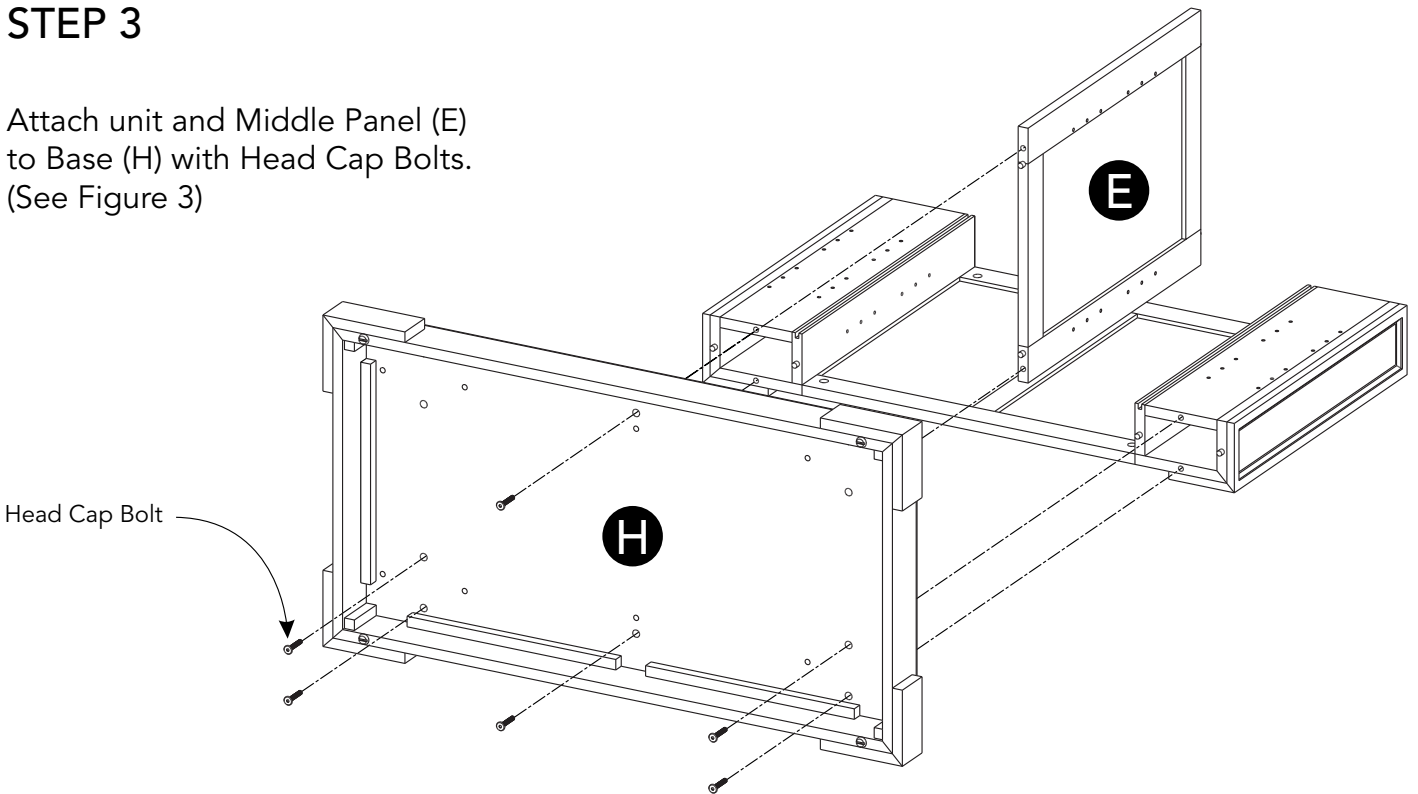
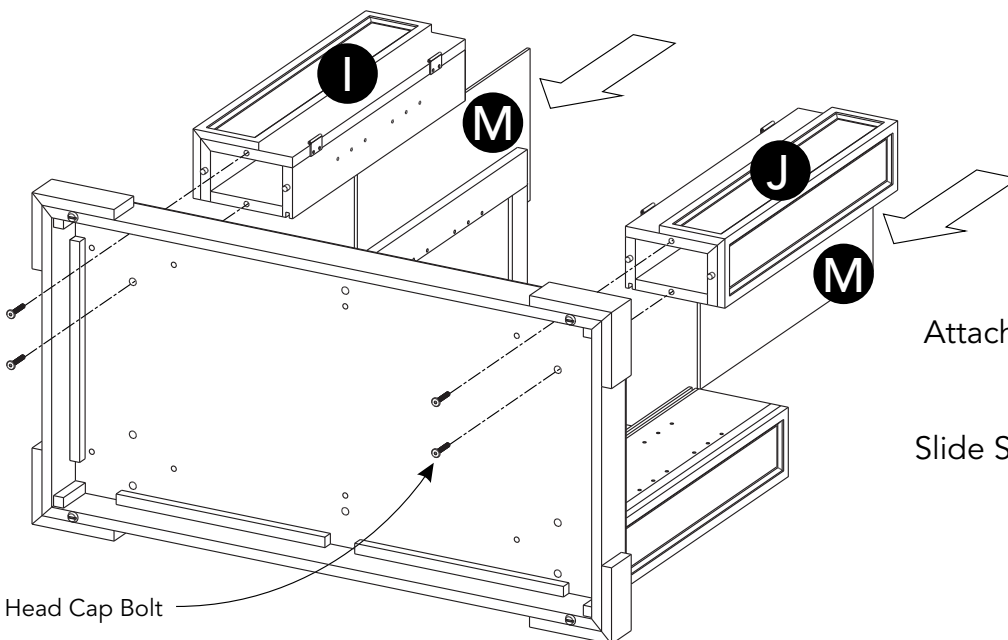

Figure 3



STEP 4

Attach Posts (I) and (J) to unit with Head Cap Bolts.

Slide Side Panels (M) into position.

Assembly Instructions 4/6

STEP 5

Attach Rails (F) to unit with Head Cap Bolts.

Insert Adjustable Pins into posts and middle panel at desired level.
(See Figure 4)

Place Shelves (G) and (O) into position.

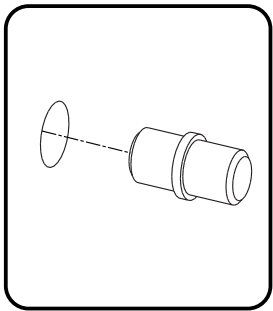
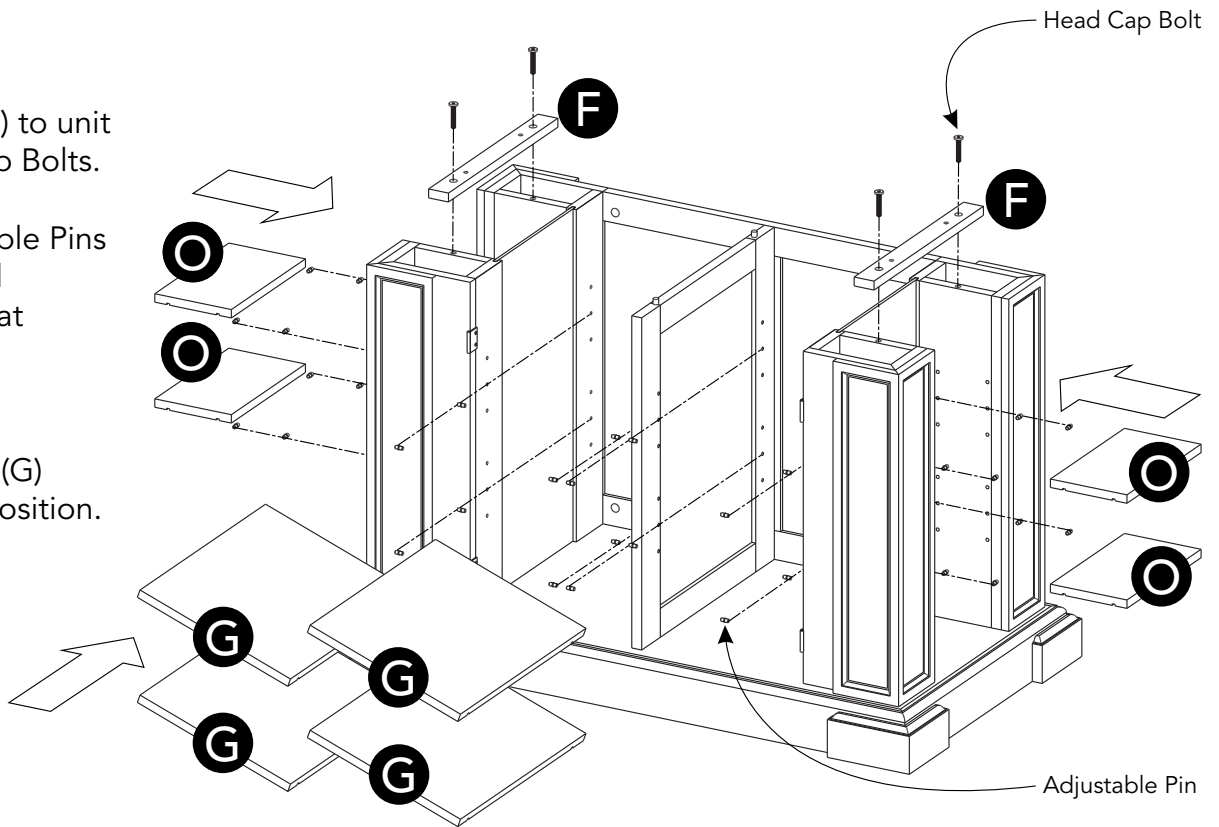

Figure 4

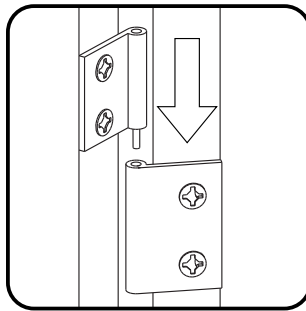

Figure 5

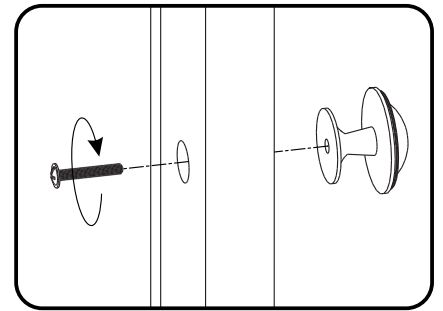
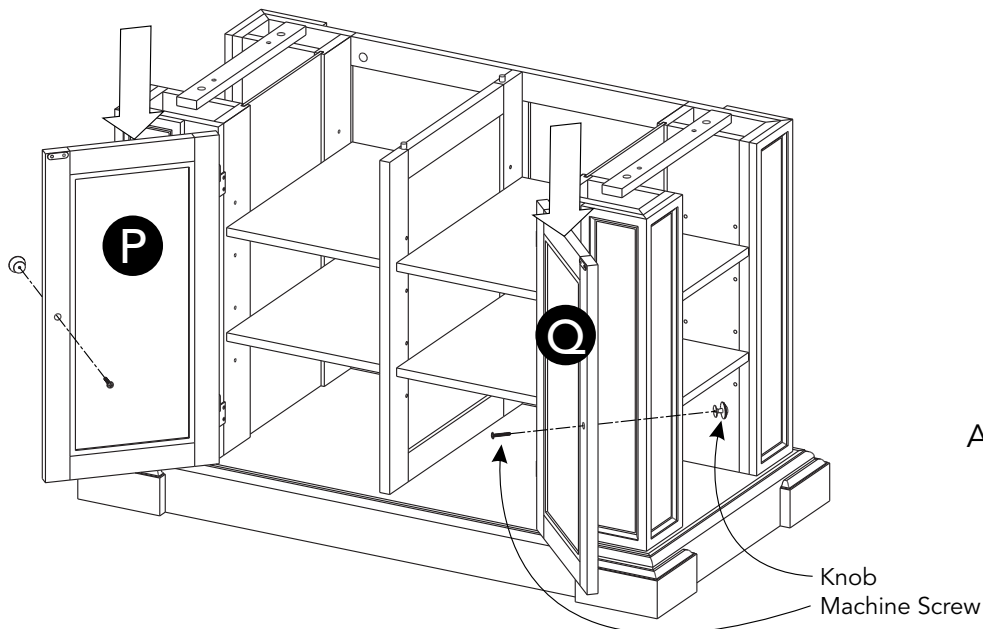

Figure 6



STEP 6

Attach Doors (P) and (Q) to unit by sliding door hinges into post hinges.
(See Figure 5)

Attach Knobs to Doors (P) and (Q) with Machine Screws.
(See Figure 6)

Assembly Instructions 5/6

STEP 7

Remove drawers from Top Unit (A).

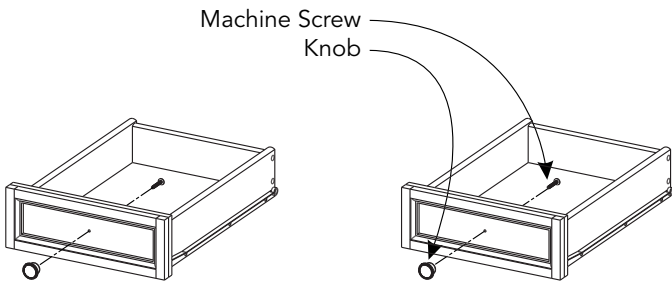
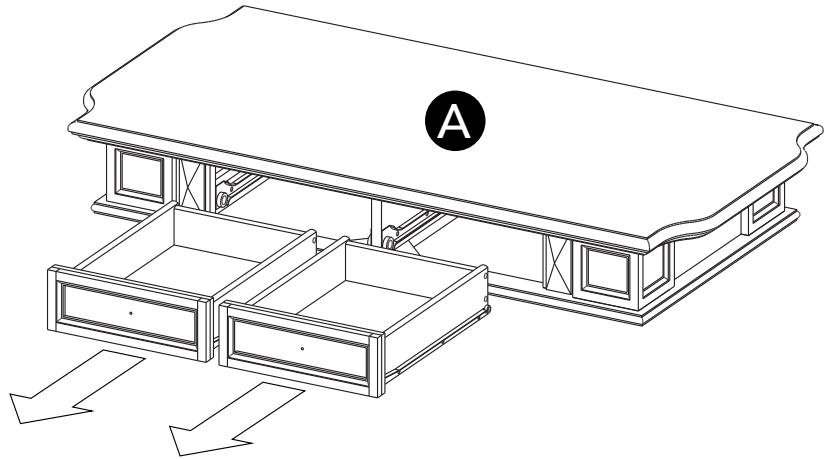

STEP 8

Attach Knobs to drawers with Machine Screws.

STEP 9

Place Top Unit (A) and Leaf Top (B) upside down on a soft cloth.

Attach Top Unit (A) to Leaf Top (B) with Wood Screws into pre-drilled holes. (See Figure 7)

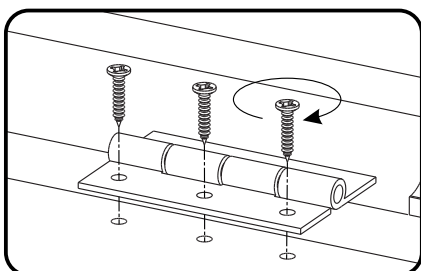
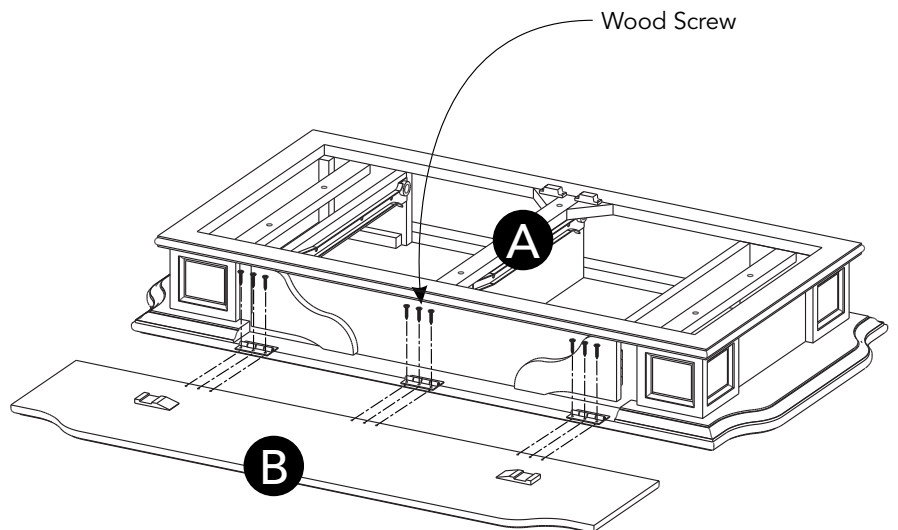
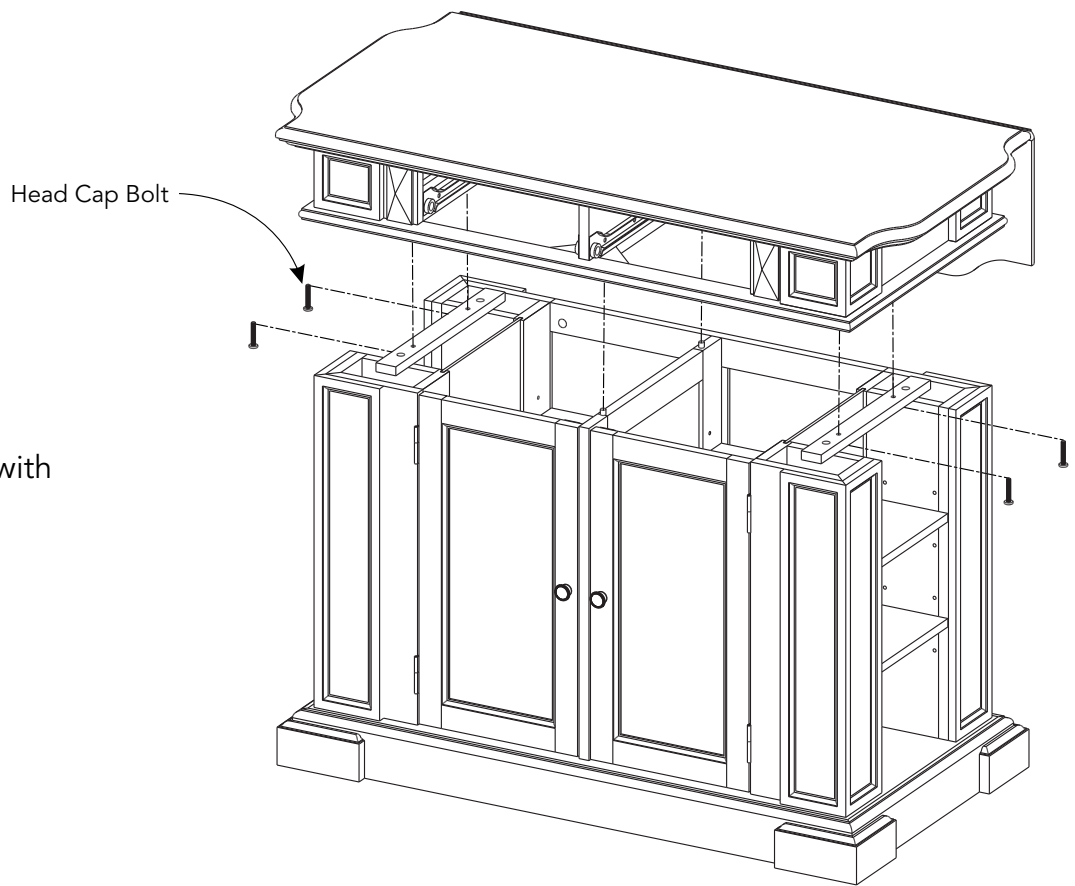

Figure 7



STEP 10

Attach top unit to unit with Head Cap Bolts.



STEP 11

Slide drawers into position.

Level unit by adjusting the adjustable levelers on bottom of unit. (See Figure 8)

Note: Unit must be level to work properly.

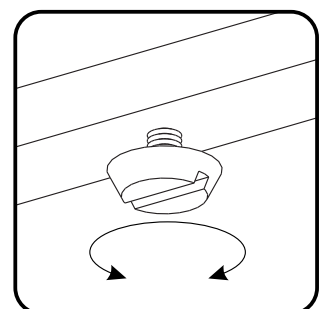
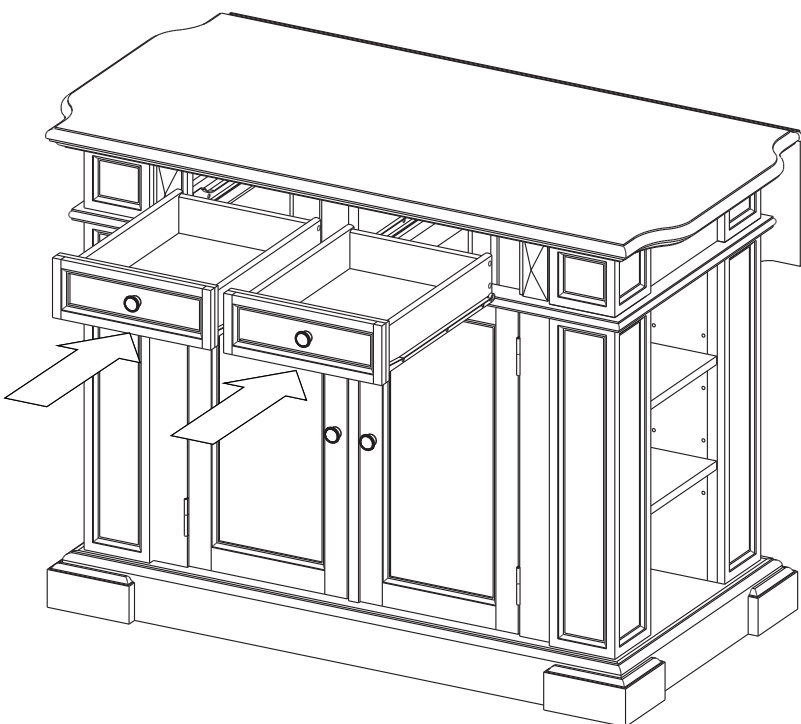

Figure 8

CARE INSTRUCTIONS

NEVER

allow liquids to remain on furniture.
Absorption causes parts to warp
and split and finishes to delaminate.

NEVER

use glass cleaners on
finished furniture. Ammonia
chemically attacks the finish.



Do not use power tools
above 8 volts to assemble.

**PREVENT
CRACKING**

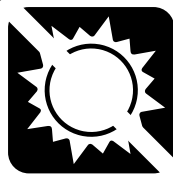

Do not place
in direct sunlight.

**PREVENT
FADING**



Do not write
directly on surface.

**PREVENT
MARKING**



Do not place hot
objects on surface.

**PREVENT
FINISH DAMAGE**

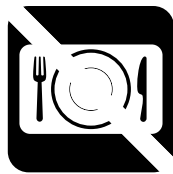

Do not use rubber
based placemats.

**PREVENT
DISCOLORING**



Do not use commercial
waxes and polishes.

**PREVENT
YELLOWING**

CLEAN

with a soft cloth moistened
in lukewarm soap and water.
Buff with a dry clean cloth.

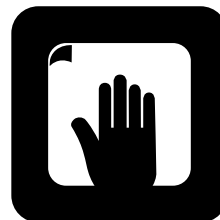

homestyles will provide replacements free of charge for missing or damaged parts within 30 days of purchase. Digital images of the defective parts may be required. If the product was not purchased from an authorized retailer, **homestyles** is under no obligation to provide replacement parts. Parts are not available for fully assembled items nor are parts available for sale. Replacements for missing or damaged parts may be requested via contact info below.

homestyles Customer Service: www.homestylesfurniture.com,
servicedesk@homestylesfurniture.com, 888-680-7460