

88 5635 88C

Bar Stool

IMPORTANT NOTE

Carefully remove all the parts from the carton and put them individually on a soft cloth to prevent scratches or other damages occurring to the parts.

We have taken great care in the design of this product and request that you carefully and strictly follow our assembly instructions to ensure a completed product as it was designed.

Home
Styles

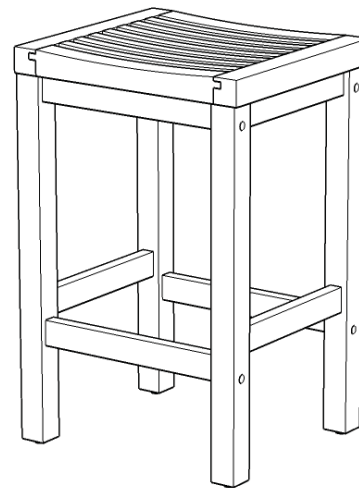

Part List

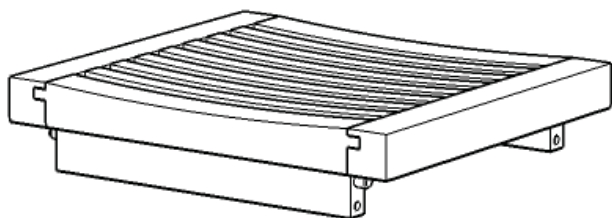

A.
Seat
1 Pc.



C.
Stretcher
2 Pcs.

B.
Side Frame
2 Pcs.

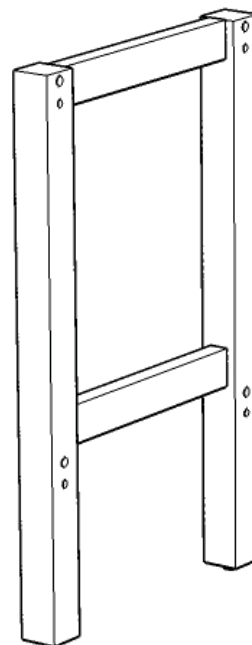

Hardware List



Small Hex Wrench
1 Pc.

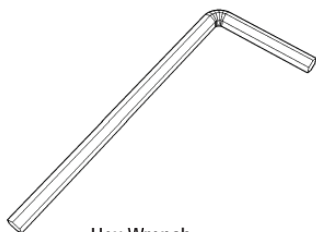

Hex Wrench
1 Pc.

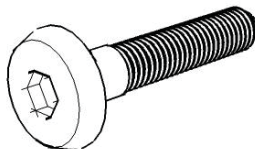

M6x60
Head Cap Bolt
8 Pcs. (+1 extra)



Cross Dowel
8 Pcs. (+1 extra)



Wood Plug
8 Pcs. (+1 extra)

Tools required for assembly : Phillips screwdriver

Home Styles Consumer Assistance: www.homestyles-furniture.com,
servicedesk@homestyles-furniture.com, 888-680-7460, 877-831-0319

Assembly Instructions 2/2

IMPORTANT

* Please keep Hex Wrench in a safe place as you may need to tighten up the Head Cap Bolts in the future.

* Do not tighten up all the Head Cap Bolts until each part is properly assembled.

* Use a soft cloth between these parts and the floor.

STEP 1

Attach Side Frame (B) to Seat (A) with Head Cap Bolts and Cross Dowels. (See Figure 1)

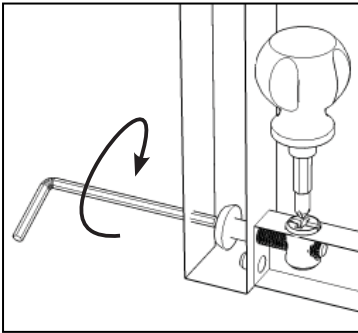
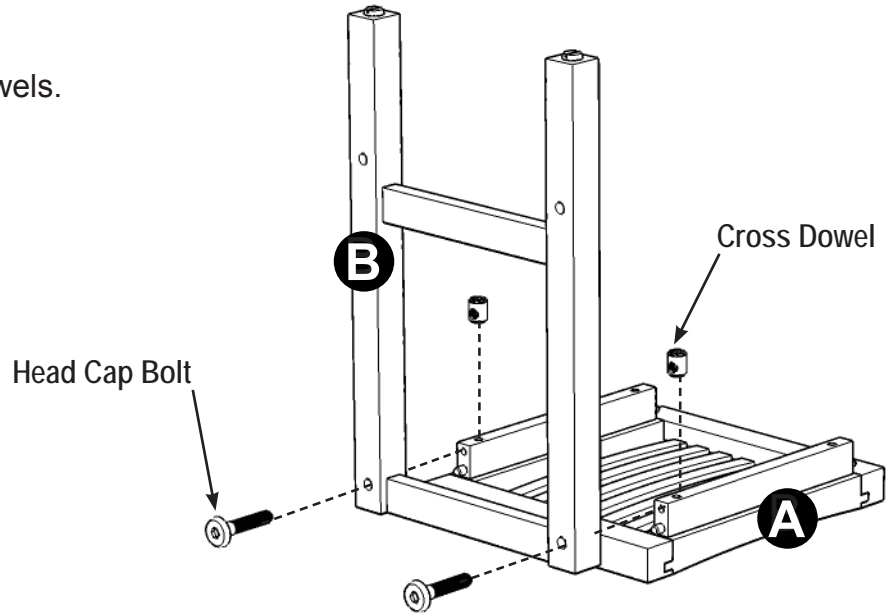
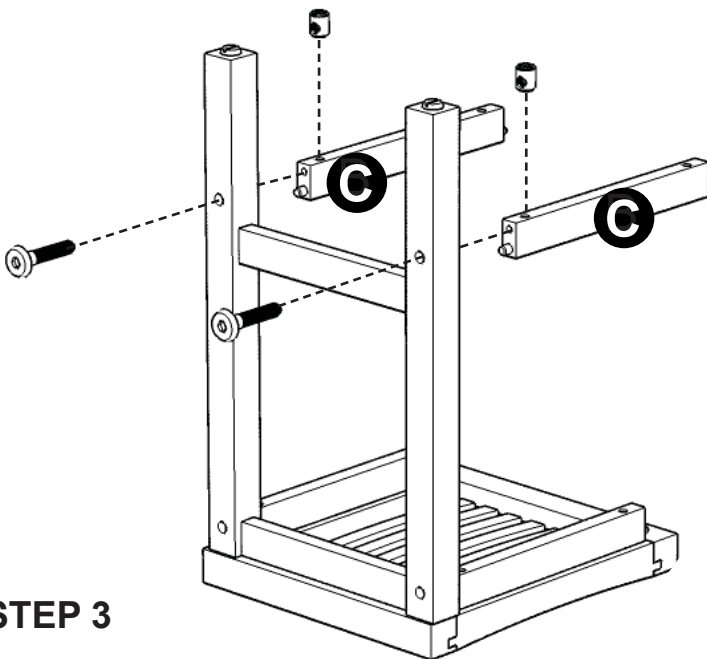

Figure 1



STEP 2

Attach Stretchers (C) to unit with Head Cap Bolts and Cross Dowels.



STEP 3

Attach Side Frame (B) to unit with Head Cap Bolts and Cross Dowels.

Cover all holes with Wood Plugs. (See Figure 2)

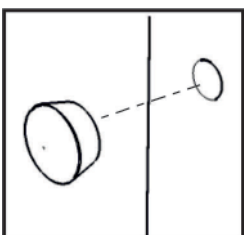

Figure 2

