

Assembly Instructions, #214957 Barrelback Counter Stool / Barrelback Bar Stool

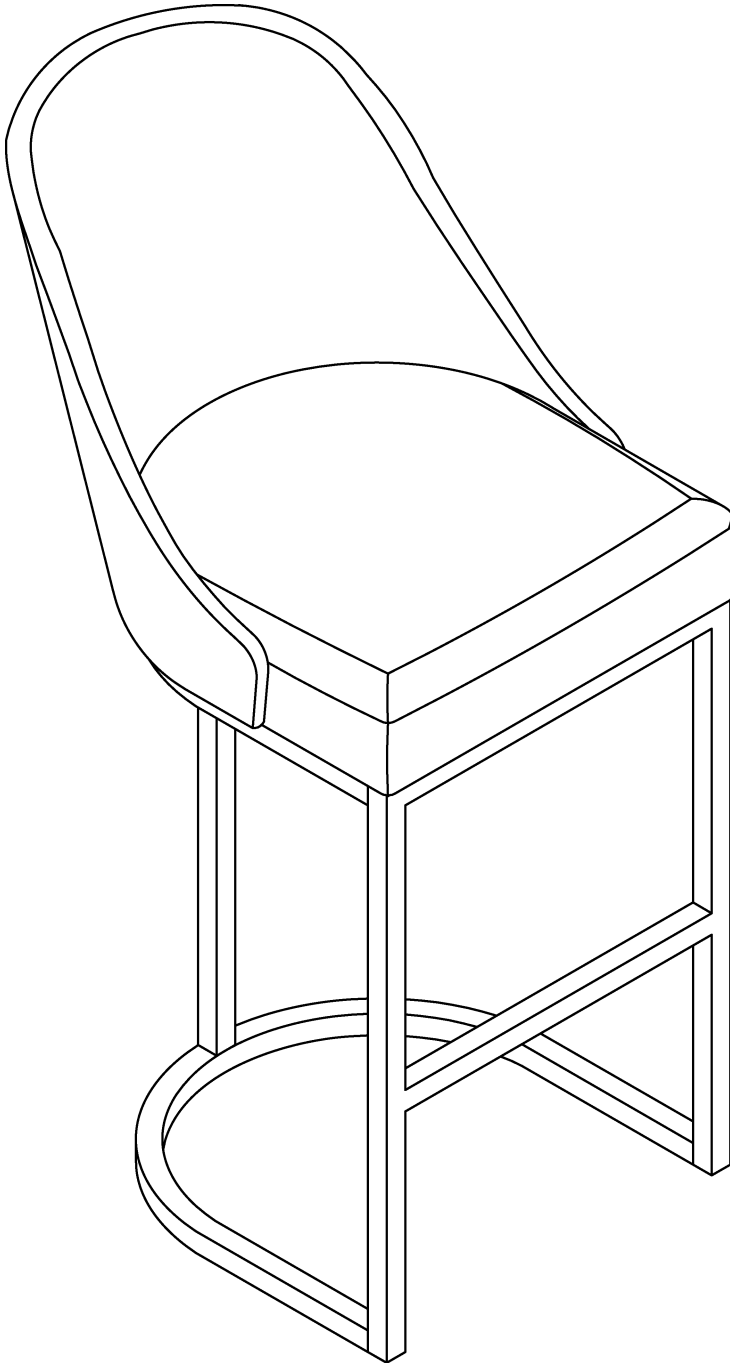

A: Seat Pad	
B: Front Frame	
C: Top U shape tube	
D: Bottom U shape tube	
E: Back Post	
F: (6) Long Bolts	
G: (8) Short Bolts	
H: (14) Flat washers	
I: (14) Lock Washers	
J: Allen Wrench	

Step 1

Fasten the bottom U shape tube into the front frame with two short bolts. Make sure the adjustable levelers face outside as per following sketch before attaching the U shape tube. Fasten the back post into U shape tube with long bolt. Do not tighten.

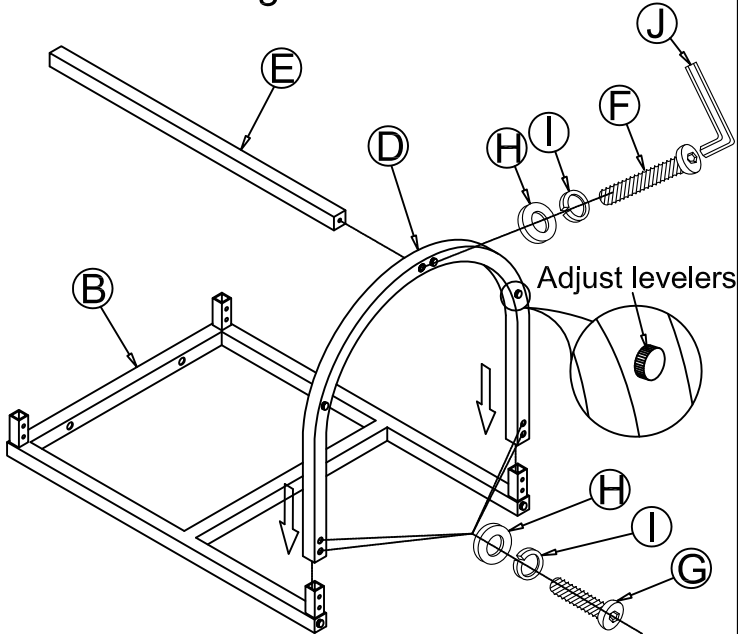

Step 2

Insert the top U shape tube into front frame and fasten the bolts. Now push U shape tubes onto the front frame to tighten the bolts. Hold the back post with one hand to tighten the long bolt. Now tighten all bolts on step 1.

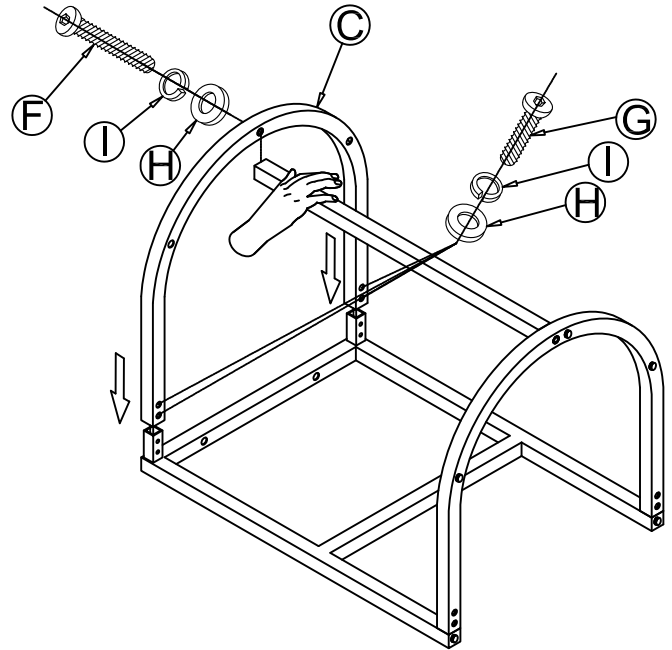

Step 3

Fasten the metal base onto the seat pad with four long bolts.

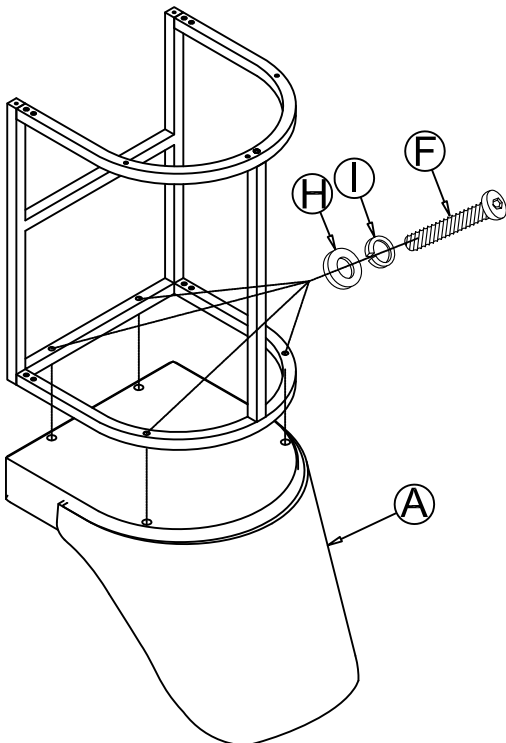

Step 3

Adjust levelers on the bottom of leg if needed.

