













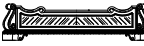

ASSEMBLY INSTRUCTION

ITEM: 5878-90251-80 5/0 Panel Headboard
 5878-90267-80 6/0-6/6 Panel Headboard
 5878-90252-80 5/0 Panel Footboard
 5878-90268-80 6/0-6/6 Panel Footboard
 5868-90253-80 5/0 Panel Rails (C)
 5878-90269-80 6/6 Rails (C)
 5878-90263-80 6/0 Rails (C)

Thank you for purchasing this quality product. Be sure to unpack carefully looking for small parts which may have come loose during shipment.
 Read all instruction and study the drawing carefully before starting the assembly process.

HARDWARE LIST					PARTS LIST			
NO.	DRAWING	DESCRIPTION	SIZE	Q'TY	NO.	DRAWING	DESCRIPTION	Q'TY
A		Threaded rod	Ø3/8"*4"	8PCS	1		Headboard	1PC
B		Curved Washer	Ø3/8"	8PCS	2		Rail (For 5/0 & 6/6 Bed)	2PCS
C		Nut	Ø3/8"	8PCS	3		Footboard	1PC
D		Open Wrench	Ø3/8"	1PC	4		Slat	5PCS (FOR 6/6 & 6/0 BED) 4PCS (FOR 5/0 BED)
E		Screw	8*32MM	20PCS (FOR 6/6 & 6/0 BED) 16PCS (FOR 5/0 BED)	5		Support leg	5PCS (FOR 6/6 & 6/0 BED) 4PCS (FOR 5/0 BED)
F		Allen Wrench	4MM	1PC	6		Rail (For 6/0 Bed)	2PCS
G		Bolt	1/4"*35MM	10PCS (FOR 6/6 & 6/0 BED) 8PCS (FOR 5/0 BED)				
H		Lock Washer	Ø1/4"	10PCS (FOR 6/6 & 6/0 BED) 8PCS (FOR 5/0 BED)				
I		Flat Washer	Ø1/4"	10PCS (FOR 6/6 & 6/0 BED) 8PCS (FOR 5/0 BED)				
J		Allen Wrench	5MM	1PC				

Please note the hardware bag to assemble side rails to HB & FB is in the box of side rails.

Step 1: Insert 2 threaded rods (A) into holes of each side post of Headboard (1) and Footboard (3), attach the end of side rails (2 or 6) to threaded rods (A) on posts by using 2 curved washers (B) and 2 nuts (C), tighten nuts (C) securely with the open wrench (D).

Note: Please make sure the end of side rail with a cap rail must be placed on top when assemble the side rail for 6/0 bed.

Step 2: Take out the support legs (5) from the rail box, attach support legs (5) to slats (4) by using bolts (G), lock washers (H) and flat washers (I). Secure bolts (G) with allen wrench (F).

Step 3: Attach slats (4) to side rails (2), use screws (E) to tighten both.

ASSEMBLY INSTRUCTION

ITEM: 5878-90251-80 5/0 Panel Headboard
5878-90267-80 6/0-6/6 Panel Headboard
5878-90252-80 5/0 Panel Footboard
5878-90268-80 6/0-6/6 Panel Footboard
5868-90253-80 5/0 Panel Rails (C)
5878-90269-80 6/6 Rails (C)
5878-90263-80 6/0 Rails (C)

Thank you for purchasing this quality product. Be sure to unpack carefully looking for small parts which may have come loose during shipment.
Read all instruction and study the drawing carefully before starting the assembly process.

Step 2

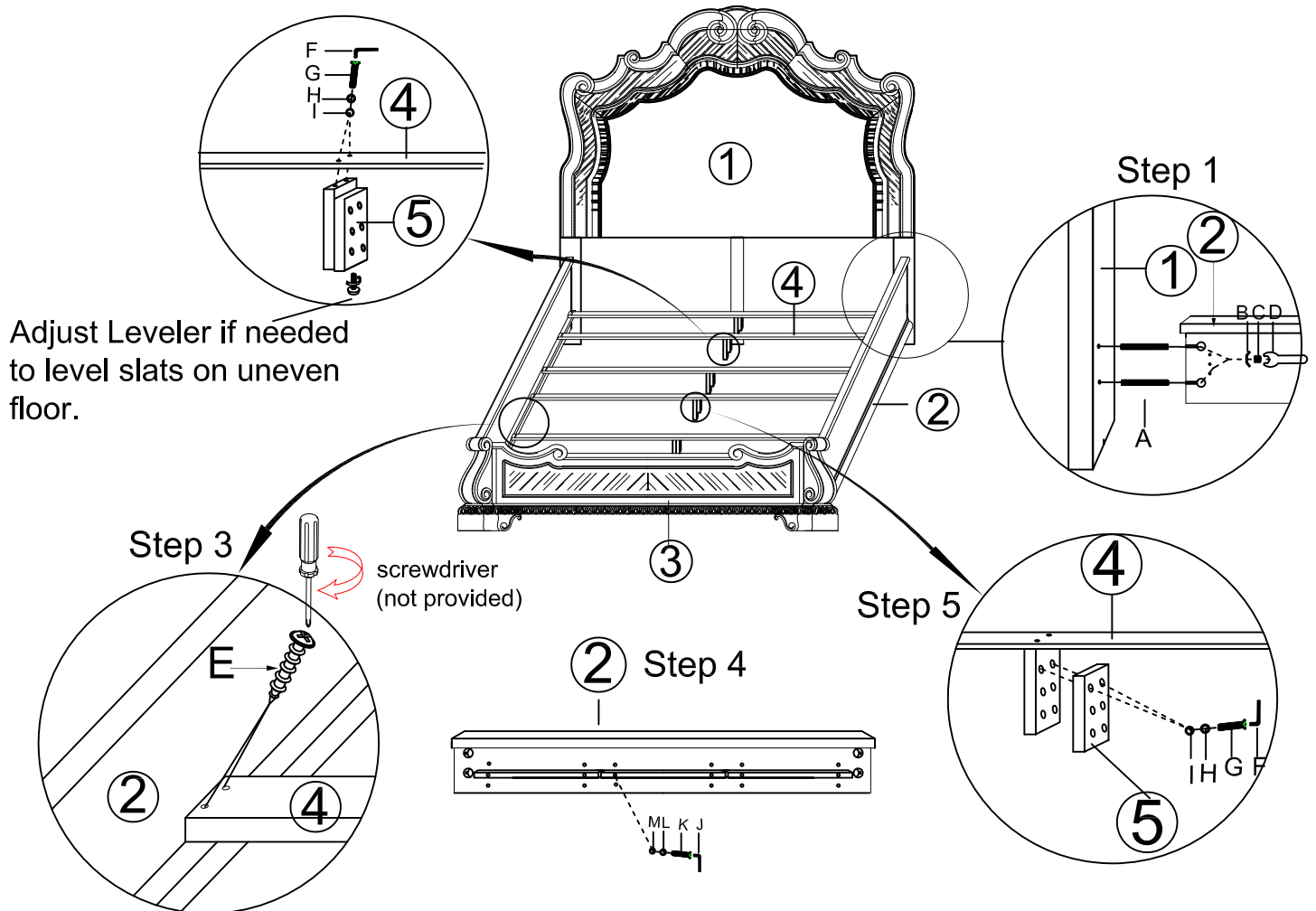

Adjust Leveler if needed to level slats on uneven floor.

Note 1: You can change the height of slats (4) by adjusting the height of cleat on side rails (2) as shown in step 4.

Remove bolts (K), lock washers (L) and flat washers (M) from the cleat with allen wrench (J), adjust the cleat to a desired position, and then secure lock washers, flat washers, bolts by turning with allen wrench(J).

Note 2: You can adjust the height of support legs (5) as shown in step 5.

Unscrew bolts on support legs (5) with allen wrench (F). Adjust the height of support legs, align the holes on 2pcs of woods and tighten them together with bolts (G), lock washers (H) and flat washers (I) by turning with allen wrench (F).