

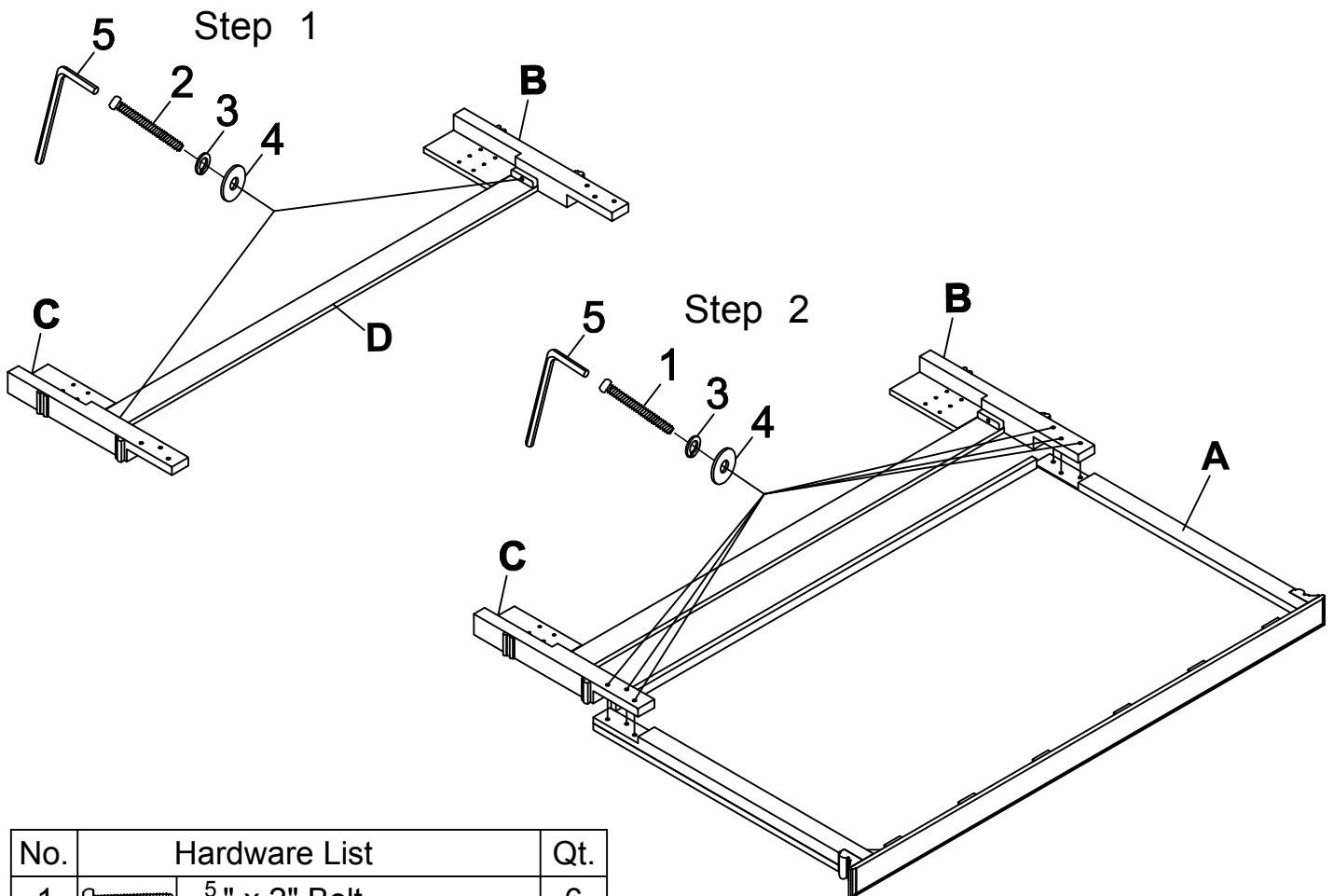



















Thank you for purchasing this quality product from A.R.T. Furniture. Be sure to check all packing material for parts which may have come loose inside the carton during shipment. Identify and count all parts and compare with the parts list below.

Note: Some furniture is heavy, it is recommended that two people assembly this item to avoid injury or damage.



No.	Hardware List		Qt.
1		$\frac{5}{16}$ " x 2" Bolt	6
2		$\frac{5}{16}$ " x 1 $\frac{3}{4}$ " Bolt	2
3		$\frac{5}{16}$ " Lock Washer	8
4		$\frac{5}{16}$ " Flat Washer	8
5		5mm Allen	1
6		#8 x 28mm Screws	10
7		$\frac{5}{16}$ " x 3 $\frac{3}{8}$ " Threaded bolt	8
8		$\frac{5}{16}$ " Half moon washer	8
9		$\frac{5}{16}$ " Lock Washer	8
10		$\frac{5}{16}$ " NUT	8
11		12mm Wrench	1

No.	PARTS LIST		Qt.
A		Headboard	1
B		Right Leg	1
C		Left Leg	1
D		Stretcher	1
E		Footboard	1
F		Slats	5
G		Support legs	5
H		Side Rails	2



Step 3

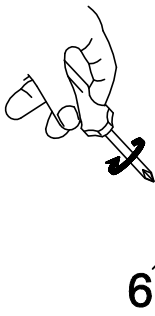
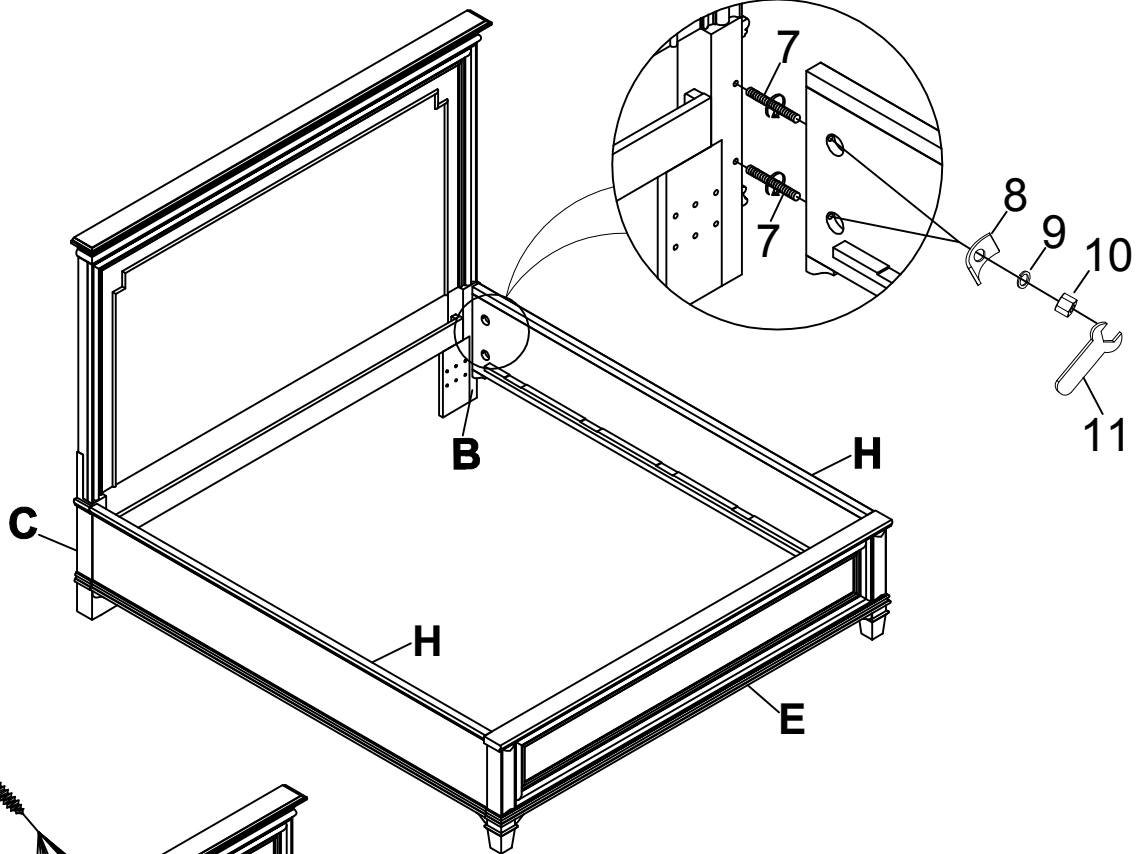

Step 4

