

PLEASE CONTACT US FIRST

TollFree: 1-800-935-3959 (Mon. Fri. 9:00AM to 5:00 PM EST)

✉ support@teamson.com

☎ 1-631-274-3353

Thank you for choosing Teamson produce. If you need help with assembly or if you are missing parts, hardware, we are here to help !



Versanora

Item No: VNF-00079W

Item name: Versanora - Ashton Rectangular Dining Table - Faux Marble/Walnut

#### Warning

Small parts and sharp points may be present prior to assembly.









Please follow the assembly instructions closely. Improper assembly can result in personal or property damage. 2 adults are required to safely assemble this product.

#### Care Instructions

Dust often using a clean, soft, dry and lint-free cloth. • When blot spills, wipe with a clean, damp cloth immediately. We do not recommend the use of chemical cleansers, abrasives or furniture polish on our lacquered finish.



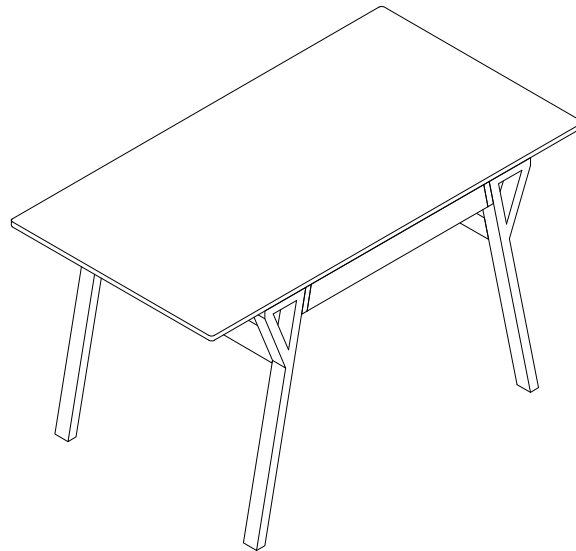

Periodically check to make sure all connections are tight. Re-tighten if necessary.

#### Hardware List:

A		4PCS
B		4PCS
C		4PCS
D		8PCS
E		8PCS
F		8PCS
J		8PCS
H		1PCS

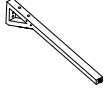







#### Part List:

1	2	3	4
			
2PCS	2PCS	2PCS	1PCS

MADE IN CHINA

www.teamson.com

# STEP 1

A:		4 PCS
B:		4 PCS
C:		4 PCS
D:		8 PCS
E:		8 PCS
F:		8 PCS
H:		1 PCS

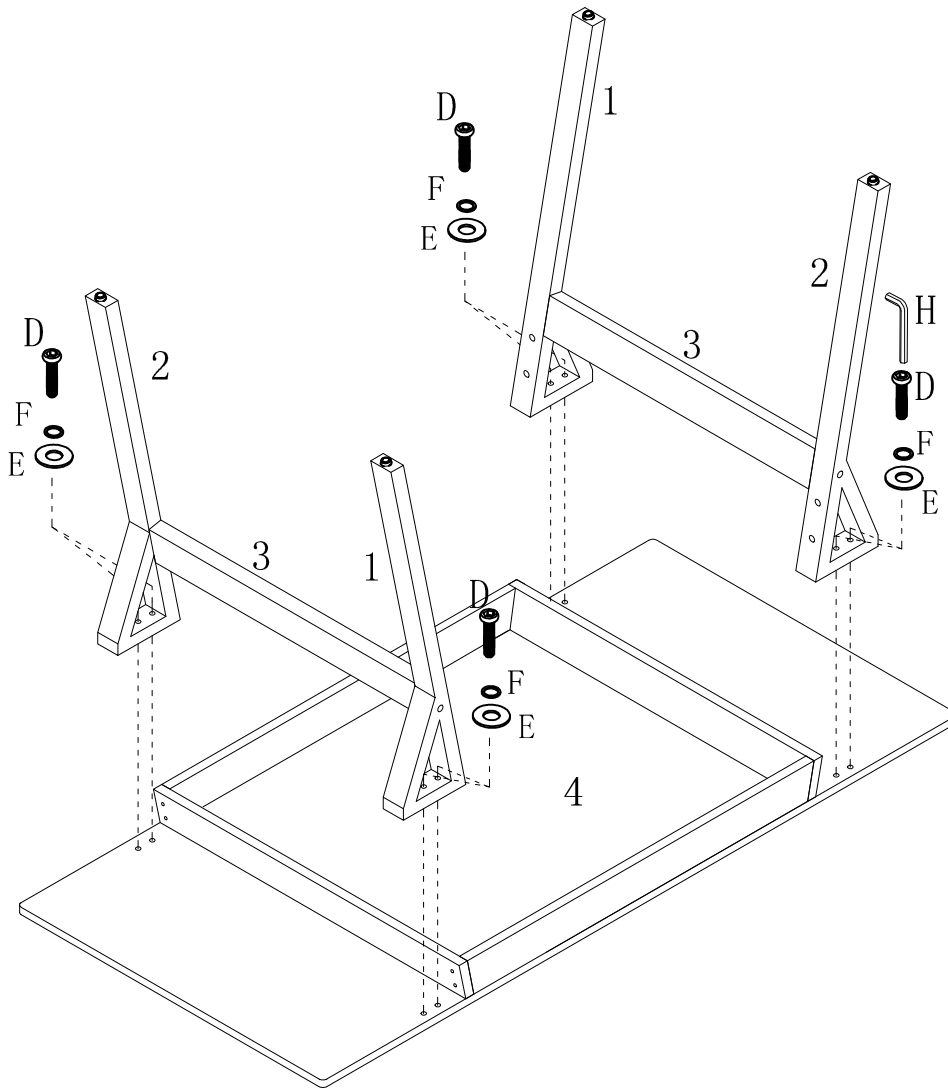
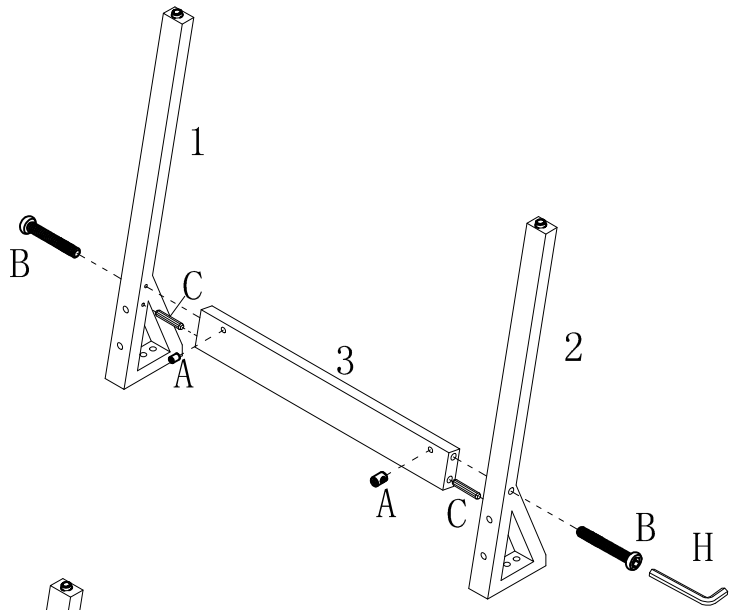



MADE IN CHINA

[www.teamson.com](http://www.teamson.com)

STEP 2

Anti -Tip hardware assemble

J:		8 PCS
H:		1 PC

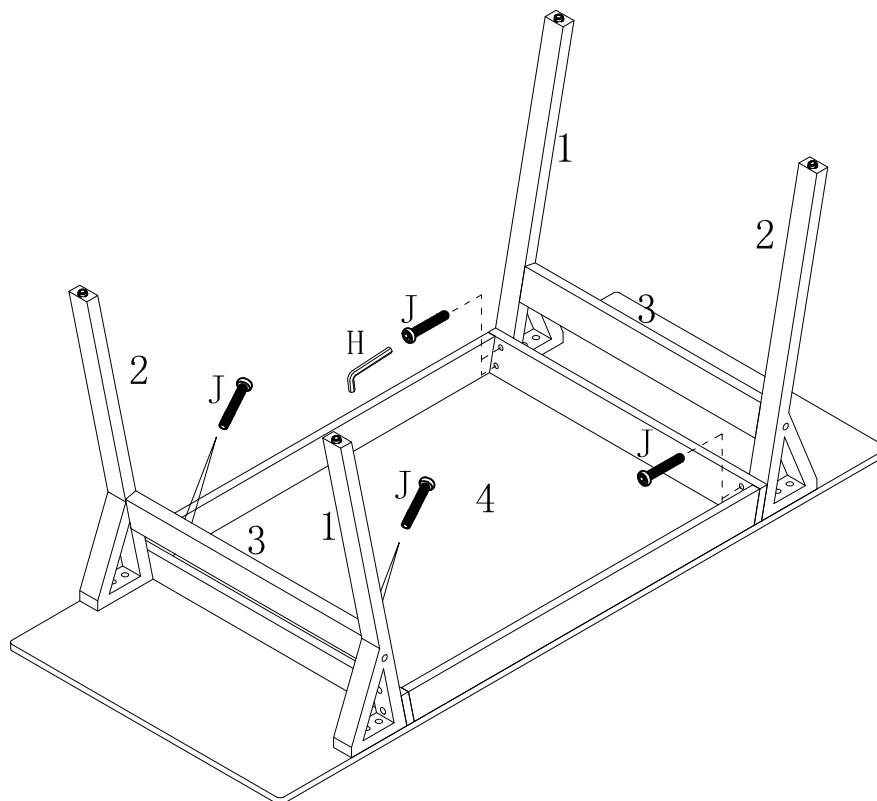

STEP 3

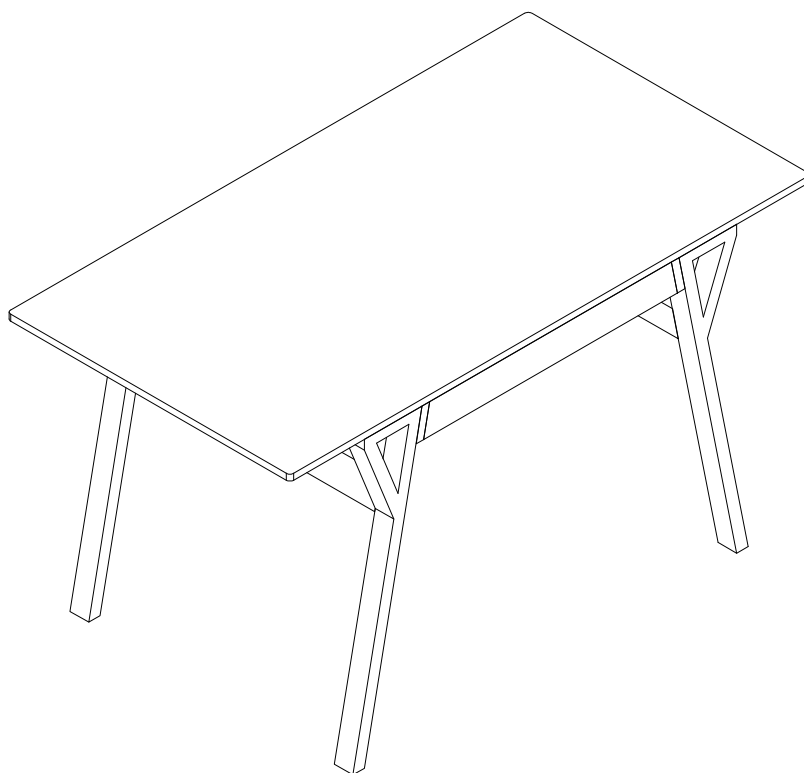

MADE IN CHINA

[www.teamson.com](http://www.teamson.com)