

SPECIFICATIONS

DESCRIPTION

- Scale-free
- 150 cm (59") double interlock flexible hose, swivel and 2 check valves
- Ø19 mm (3/4") slide bar
- 3-jet hand shower
- Easy-Glide left cursor

FLOW

- 6.7 L/min, 1.8 gpm (US) 60psi

STANDARDS

- CSA B125.1 / ASME A112.18.1

WARRANTY

- Most products or parts carry "Limited Warranties" against manufacturing defects. For US customers please visit houseofrohl.com/support and for Canadian customers please visit houseofrohl.ca/support for complete product and finish warranty.



Hand shower rail

MODELS: 4871 SERIES

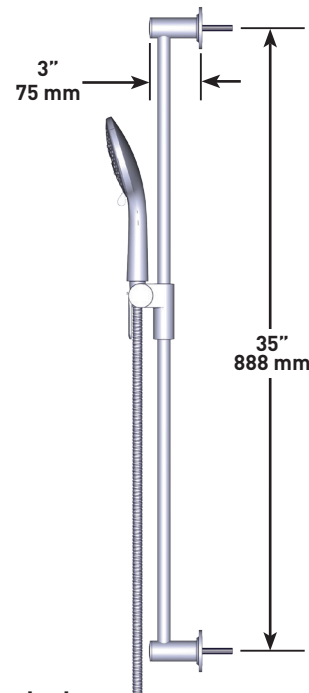
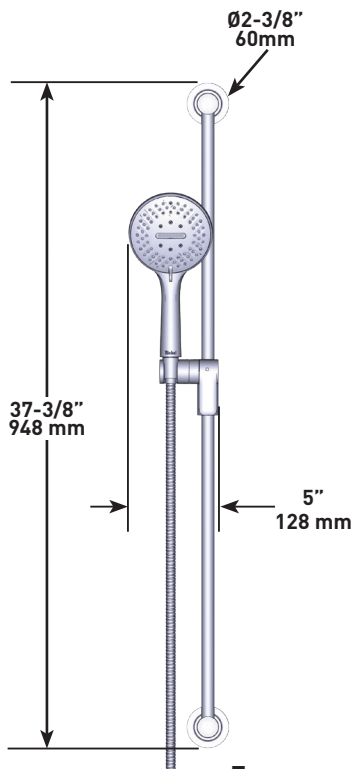

For warranty or additional information, contact:

U.S.A.
houseofrohl.com/support
 1-800-777-9762

QUEBEC / MARITIMES / WESTERN CANADA
 QUÉBEC / MARITIMES / OUEST CANADIEN
 QUEBEC / MARITIMOS / CANADA OCCIDENTAL
houseofrohl.ca/support
 1-866-473-8442

ONTARIO
houseofrohl.ca/support
 1-800-287-5354

SPÉCIFICATIONS

DESCRIPTION

- Anticalcaire
- Flexible de douche double agrafage de 150 cm.
- Écrou tournant et 2 clapets anti-retour
- Ø19 mm (3/4") barre de douche
- Douchette 3 jets
- Support coulissant, système "Easy Glide"

FLOW

- 6.7 L/min, 1.8 gpm (US) 60psi

NORMES

- CSA B125.1 / ASME A112.18.1

GARANTIE

- La plupart des produits ou pièces comprend des «garanties limitées» contre les défauts de fabrication. Pour les clients des États-Unis : veuillez consulter houseofrohl.com/support; Pour les clients du Canada : veuillez consulter houseofrohl.ca/support pour connaître les conditions complètes de la garantie des produits et finis.



Douchette sur rail
MODÈLES: 4871 Séries

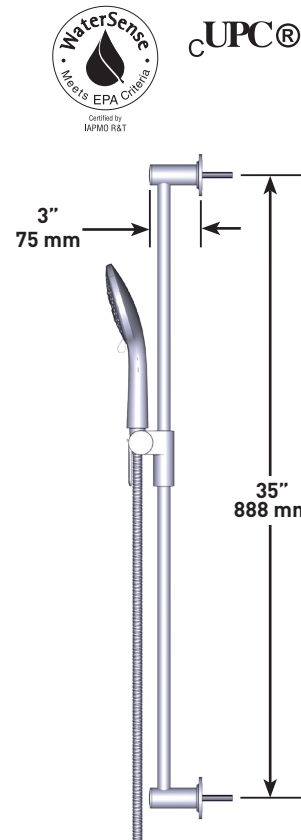
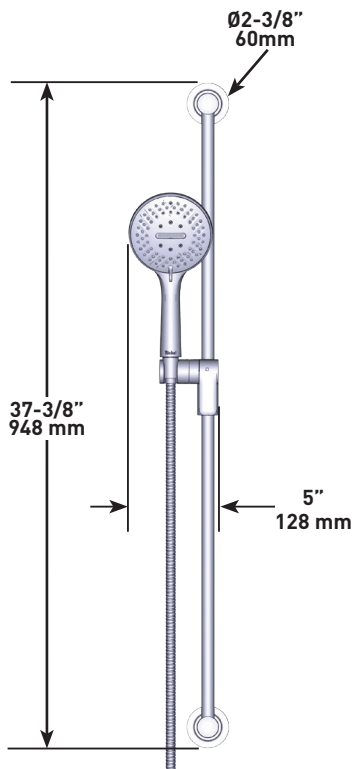

Si vous souhaitez obtenir de l'information supplémentaire à propos de la garantie ou de tout autre élément, communiquez avec :

U.S.A.
houseofrohl.com/support
 1-800-777-9762

QUEBEC / MARITIMES / WESTERN CANADA
 QUÉBEC / MARITIMES / OUEST CANADIEN
 QUEBEC / MARITIMOS / CANADA OCCIDENTAL
houseofrohl.ca/support
 1-866-473-8442

ONTARIO
houseofrohl.ca/support
 1-800-287-5354

ESPECIFICACIONES

DESCRIPCIÓN

- Anticalcárea
- Flexo de ducha reforzado de 150 cm. Tuerca giratoria y 2 válvulas anti retorno
- Ø19 mm (3/4") barra de ducha
- Ducha de mano 3 jets
- Soporte deslizante, sistema "Easy Glide"

FLOW

- 6.7 L/min, 1.8 gpm (US) 60psi

ESTÁNDARES

- CSA B125.1 / ASME A112.18.1

GARANTÍA

- La mayoría de los productos o piezas cuentan con "Garantías Limitadas" por defectos de fabricación. A los clientes en EE. UU. se les recomienda visitar houseofrohl.com/support y a los clientes en Canadá, houseofrohl.ca/support, para consultar las condiciones completas de la garantía de los productos y acabados.



Barra de ducha de mano
MODELOS: 4871 SERIE

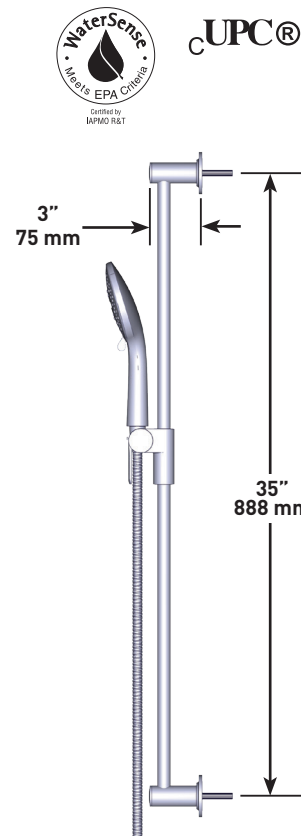
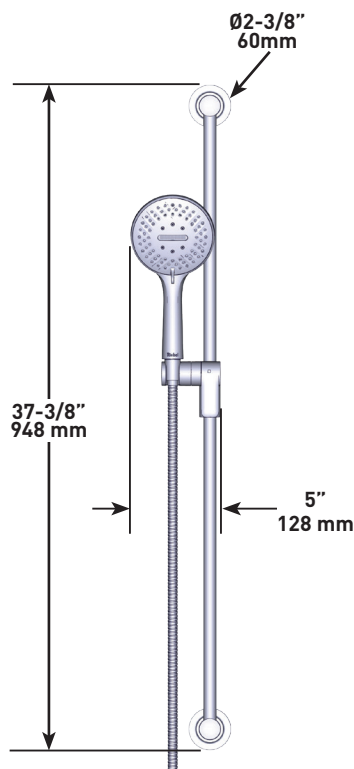

Para preguntas sobre la garantía o para obtener más información, favor de comunicarse con:

U.S.A.
houseofrohl.com/support
1-800-777-9762

QUEBEC / MARITIMES / WESTERN CANADA
QUÉBEC / MARITIMES / OUEST CANADIEN
QUEBEC / MARITIMOS / CANADA OCCIDENTAL
houseofrohl.ca/support
1-866-473-8442

ONTARIO
houseofrohl.ca/support
1-800-287-5354