

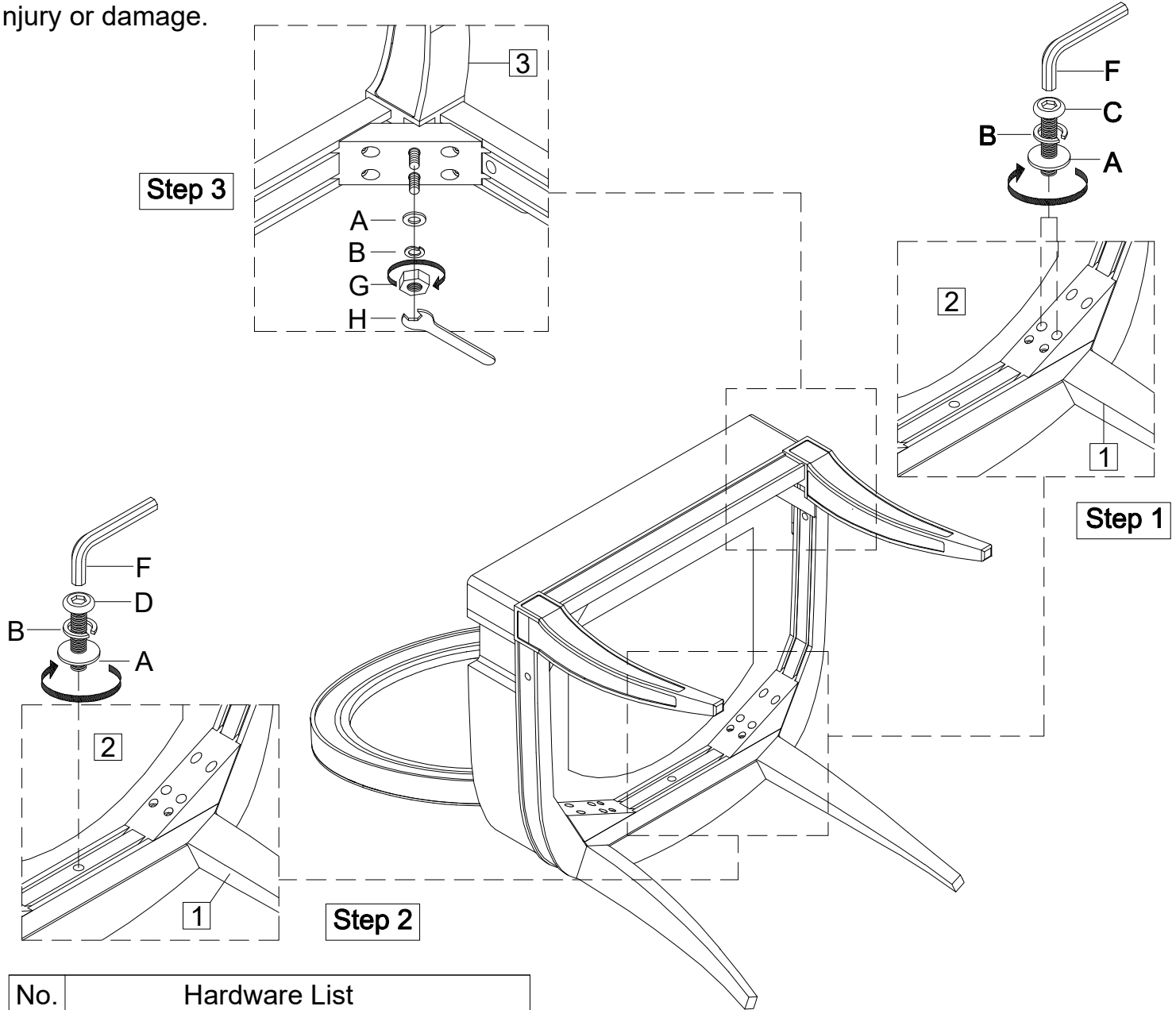









Thank you for purchasing this quality product from A.R.T. Furniture. Be sure to check all packing material for parts which may have come loose inside the carton during shipment. Identify and count all parts and compare with the parts list below.

Note: Some furniture is heavy, it is recommended that two people assembly this item to avoid injury or damage.



No.	Hardware List		
A		$\frac{5}{16}$ " X 19mm Flat Washer	11
B		$\frac{5}{16}$ " Lock Washer	11
C		$\frac{5}{16}$ " x 3 $\frac{1}{2}$ " Bolt	4
D		$\frac{5}{16}$ " x 2 $\frac{1}{4}$ " Bolt	1
E		$\frac{5}{16}$ " x 1 $\frac{3}{4}$ " Bolt	2
F		5mm Allen Wrench	1
G		$\frac{5}{16}$ " Nut	4
H		$\frac{5}{16}$ " Wrench	1
I		#8x1 $\frac{1}{2}$ " Screw	2

Parts List			
1		Chair Back	1
2		Cushion Seat	1
3		Right Front Legs	1
4		Left Front Legs	1
5		Arm	1set

Step 5

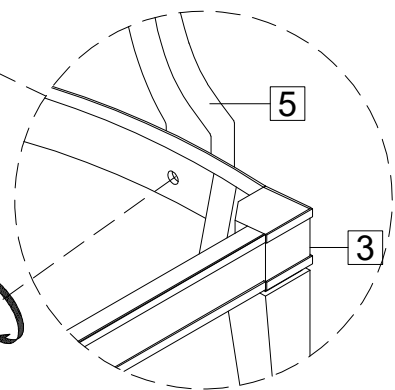
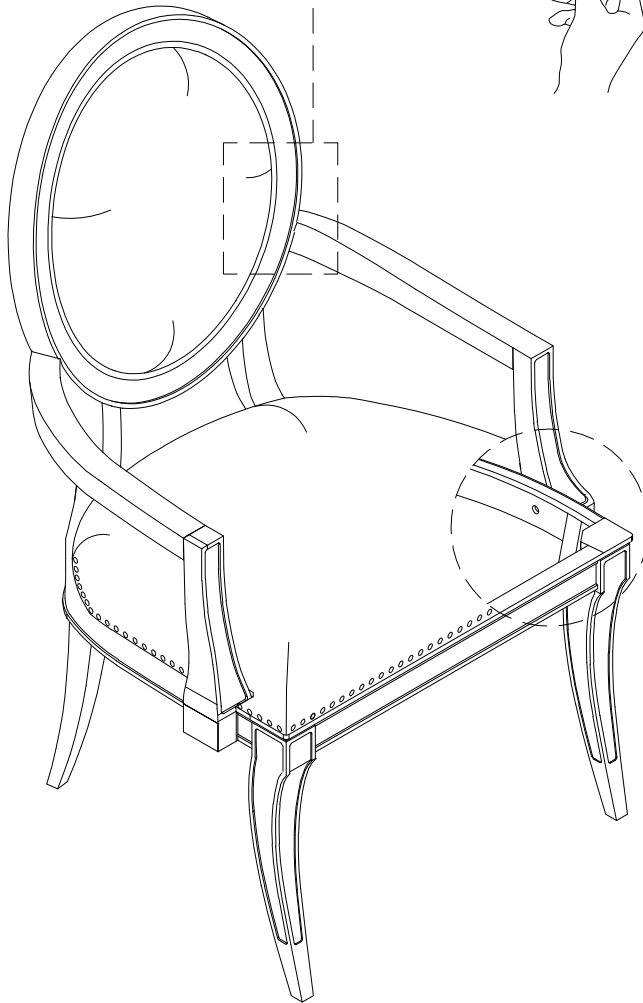
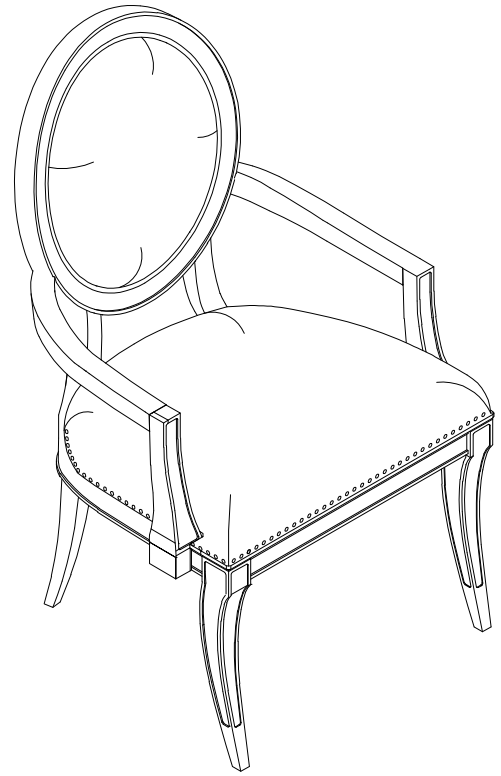
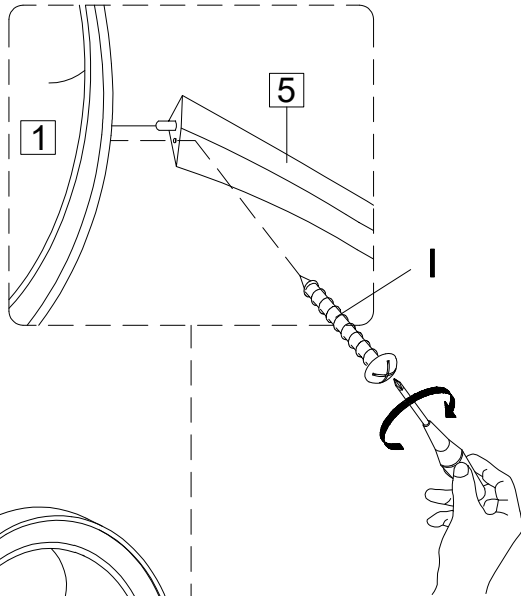

Step 4

