

homestyles

20 08002 0351

High Dining Table



IMPORTANT

Carefully remove all the parts from the carton and place them individually on a soft cloth to prevent scratches or other damage.

Carefully and strictly follow these assembly instructions to ensure a completed product as designed.

Do not use power tools above 8 volts to assemble.

Part List

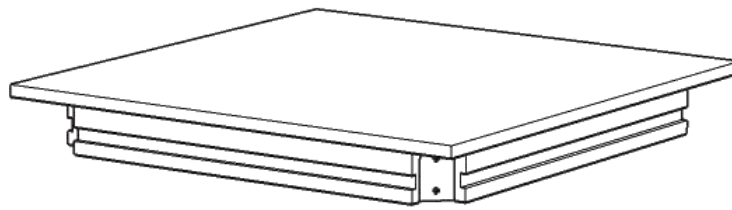

A.
Top
1 pc.

Hardware List



Hex Wrench
1 pc.



Small Hex Wrench
1 pc.



Flat Washer
8 pcs. (+1 extra)



Spring Washer
8 pcs. (+1 extra)

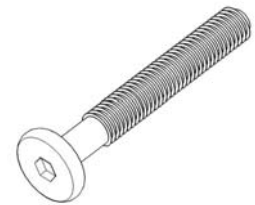

M8x60
Head Cap Bolt
8 pcs. (+1 extra)

Carton 20 08002 0352 is also needed for assembly.

Tool(s) required for assembly: Level

Home Styles Customer Service: www.homestyles-furniture.com,
servicedesk@homestyles-furniture.com, 888-680-7460, 877-831-0319

Assembly Instructions 2/3

IMPORTANT

- Use a soft cloth between these parts and the floor.
- Do not use power tools above 8 volts to assemble.
- Do not tighten all the bolts until each part is properly assembled.
- The unit must be level to work properly. Use the included adjustable levelers to level.
- Keep Hex Wrench as the bolts may need to be tightened up in the future.

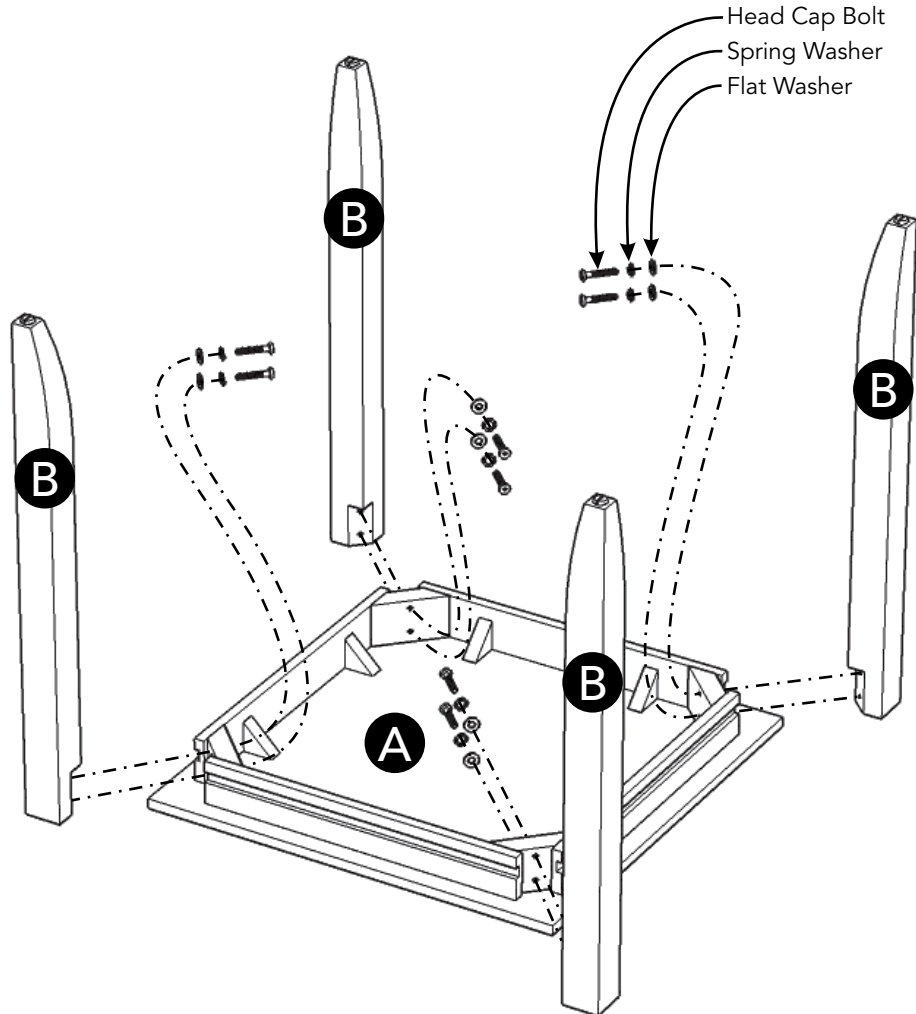

STEP 1

Place Top (A) upside down on a soft cloth.

Attach Legs (B) to Top (A) with Flat Washers, Spring Washers and Head Cap Bolts, tightening bolts only halfway.
(See Figure 1)

Tighten all Head Cap Bolts.

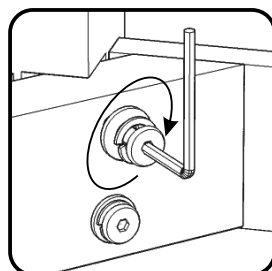
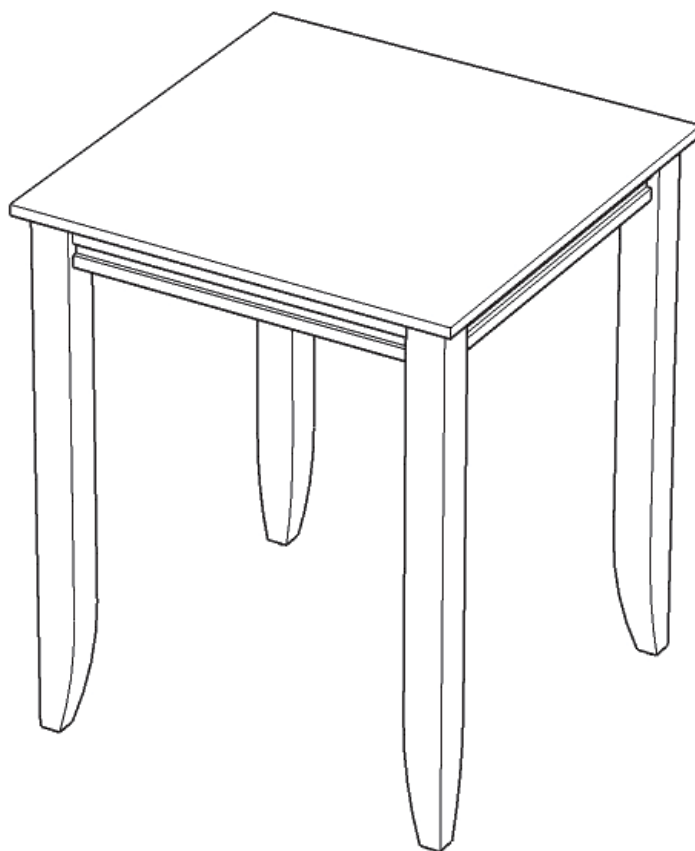

Figure 1



STEP 2

Turn unit over to its upright position.

Level unit by adjusting the adjustable levelers on bottom of legs.
(See Figure 2)

Note: Unit must be level to work properly.

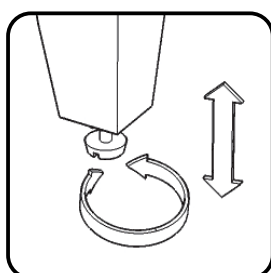

Figure 2

CARE INSTRUCTIONS

NEVER

allow liquids to remain on furniture.
Absorption causes parts to warp
and split and finishes to delaminate.

NEVER

use glass cleaners on
finished furniture. Ammonia
chemically attacks the finish.



Do not use power tools
above 8 volts to assemble.

**PREVENT
CRACKING**

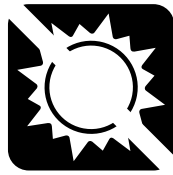

Do not place
in direct sunlight.

**PREVENT
FADING**



Do not write
directly on surface.

**PREVENT
MARKING**



Do not place hot
objects on surface.

**PREVENT
FINISH DAMAGE**

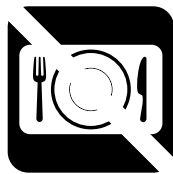

Do not use rubber
based placemats.

**PREVENT
DISCOLORING**



Do not use commercial
waxes and polishes.

**PREVENT
YELLOWING**

CLEAN

with a soft cloth moistened
in lukewarm soap and water.
Buff with a dry clean cloth.

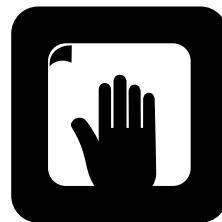

Home Styles will provide replacements free of charge for missing or damaged hardware or parts within 30 days of purchase. Digital images of the defective parts may be required. If the product was not purchased from an authorized retail affiliate, Home Styles is under no obligation to provide replacement parts. Parts are not available for fully assembled items nor are parts available for sale. Replacements for missing or damaged hardware or parts may be requested at:

www.homestyles-furniture.com/customer-service/replacement-parts

Home Styles Customer Service: www.homestyles-furniture.com,
servicedesk@homestyles-furniture.com, 888-680-7460, 877-831-0319