

# USER'S MANUAL

## 820BRGB

**BLUETOOTH®** | MP3-COMPATIBLE  
DIGITAL MEDIA AM/FM RECEIVER







 **Bluetooth®**



**BOSS®**  
AUDIO SYSTEMS

# CONTENTS

---

Precautions.....	1
Precautions & Warnings.....	1
Lithium Battery Cell Warnings.....	1
Drivers and Connections.....	1
Other Warnings.....	1
Installation.....	2
Installation Opening.....	2
To Install the Car Radio.....	2
Electrical Connections.....	3
Control Panel Button Locations.....	4
General Operation.....	5
Turn Unit On/Off.....	5
Adjust Volume (VOL).....	5
Adjust Menu Options (SEL).....	5
Set the Clock (CLK).....	5
Change the Source (SRC).....	6
Mute on/off.....	6
Loudness on/off.....	6
Preset EQ(Equalizer).....	6
USB Port.....	6
Hands-free Microphone.....	6
AUX input Connector.....	6
Reset System (Reset).....	6
Radio Operation.....	7
Switch Between USA area and Europe area Frequency.....	7
Change Bands (BAND).....	7
Manual Tuning (  /  ).....	7
Auto Seek Tuning (  /  ).....	7
To Store/Recall Preset Stations (1 - 6).....	7
Automatic Store Station / Preset Station Scan (AMS).....	7
Local/DX.....	7
Stereo/Mono.....	7
USB Operation.....	8
To Insert a USB.....	8
Eject USB.....	8
Play/Pause.....	8
Next/Previous Track.....	8
Fast Forward/Backward.....	8
Introduction Scan.....	8
Repeating the same track.....	8
Playing All Tracks in Random.....	8
Track/Folder Navigation.....	8
Select the track or file for playback in MP3 format.....	8
Auxiliary Input operation.....	9
Bluetooth Operation.....	10
Pair and Connect.....	10
Make a Call.....	10
Redial Last Dialed Number.....	10
Answer a Call / Reject a Call / End a Call.....	10
Switch Audio Between Car audio and Mobile Phone.....	10
Adjust Call Volume.....	10
Audio Streaming (A2DP).....	10
Remote Control.....	11
Specifications.....	12
Troubleshooting.....	13

# PRECAUTIONS

---

## Precautions & Warnings

- To reduce the risk of fire, electric shock, and interference, do not attempt to repair this unit yourself. Refer all service to a qualified technician.
- Some MP3/WMA files may not be playable.
- Keep the volume at a reasonable level to avoid distracted driving. High volume levels may make it difficult to concentrate on traffic and road conditions while driving.
- If the car has been in direct sunlight for an extended period, you may need to reduce the temperature inside the car before turning on and using the unit.
- If the battery is disconnected, discharged, or changed, the preset memory of the unit will be lost and require reprogramming.
- The unit is designed to be installed in a level, horizontal position. For optimal performance, avoid installing the unit at an angle.
- Never use excessive force when removing or attaching the faceplate. Do not tightly grip the display and buttons to avoid damage.

## Lithium Battery Cell Warnings

- Cell leakage may cause damage to the remote control.
- Do not throw cells into fire as this may cause an explosion.
- Keep battery cells out of reach of children.

## Drives and connections

Never place any foreign objects into the openings of the car radio (USB jack, AUX IN connection). Otherwise you might damage the slots and connections.

## Others Warnings

Do not switch on the car radio for long periods of time when the motor is switched off. This could cause the car battery to discharge and the vehicle can no longer be started.

# INSTALLATION

## Installation Opening

This unit can be installed in any dashboard Having an opening as shown the right figure.

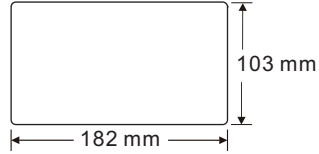

If installation angle exceeds 30 horizontal, the unit may not perform properly.

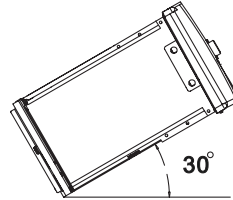

## To Install the Car Radio

1. Make sure the ignition is turned off, and then disconnect the cable from the vehicle battery's negative (-) terminal. You never want electricity running while you install this double-DIN car receiver.
2. Attach the "L" brackets (2pcs) on the both sides of the car receiver with screws(M5 x 8BM) as shown as the below figure. The others fixing screws that fix the other terminal of the "L" metal bracket, please buy from your dealer according to the drilling of holes size.
3. Consult with you nearest dealer if installation requires the drilling of holes or other modifications of the vehicle.
4. Install the car receiver in the dashboard.
5. Connect the wire harness & the antenna to the car receiver (see "Electrical Connections") being careful not to pinch any wires or cables.
6. Install the detachable faceplate & plastic outer trim ring onto the car receiver.
7. Reconnect the battery and run through all of the options on this car receiver to ensure that everything is working correctly.
8. Particulars will vary widely depending upon the kind of your car and the car you intend to install it in. Please choose the correct installation method according to the actual situation of your car. Always contact the car dealer or manufacturer if you have any questions.

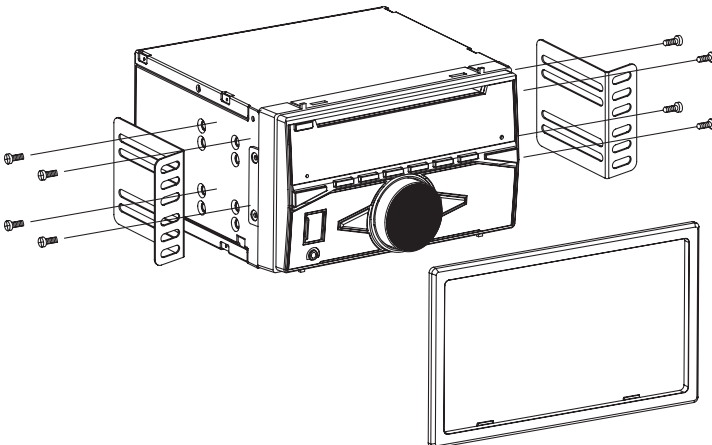

# Electrical Connections

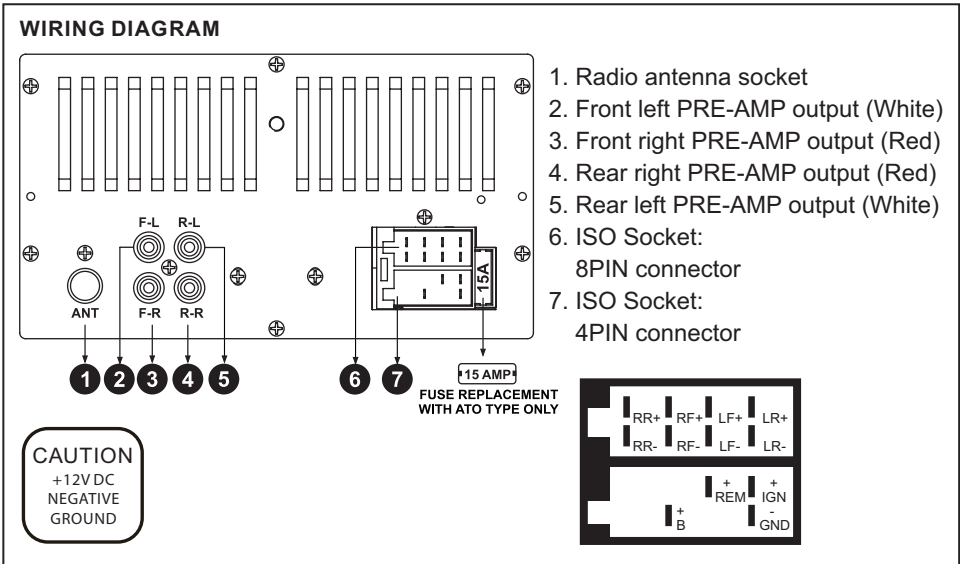

- Only use speakers with 4 ohm impedance.
- The maximum current of the Amp Remote trigger is 200mA.

# CONTROL PANEL BUTTON LOCATIONS

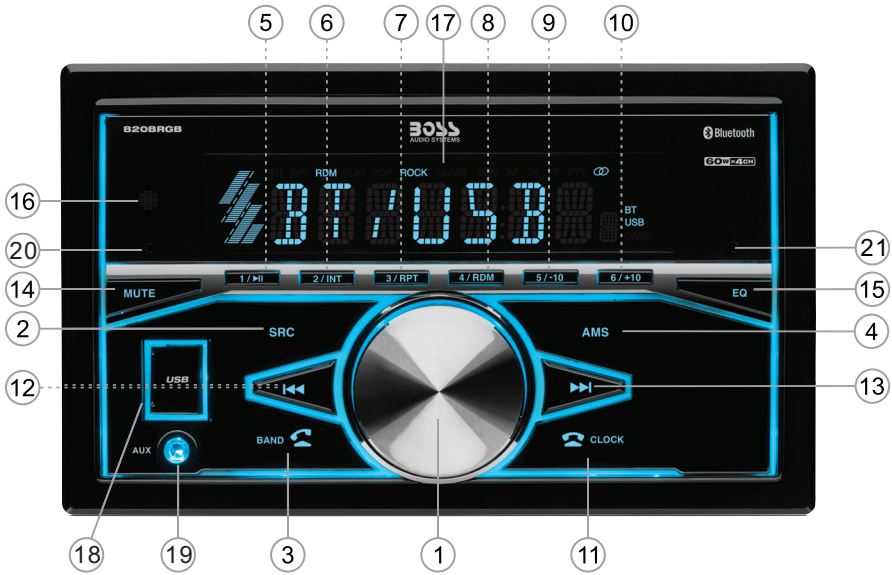

1. ⏻ (power)/Volume knob and SEL (select/menu) button
2. SRC (source) button
3. BAND (band) button, 📞 (answer call) button
4. AMS (automatic store / preset station scan, automatic music search) button
5. ⏸ (pause/play), Preset station 1 button
6. INT (intro), Preset station 2 button
7. RPT (repeat), Preset station 3 button
8. RDM (random), Preset station 4 button
9. -10 (previous 10 tracks), Preset station 5 button
10. +10 (next 10 tracks), Preset station 6 button
11. CLOCK (clock setting) button, 📞 (end call) button
12. ⏮ (tune down, seek down, previous, fast reverse) button
13. ⏭ (tune up, seek up, next track, fast forward) button
14. MUTE button
15. EQ (Equalizer)
16. IR remote sensor
17. LCD Display
18. USB Port
19. AUX IN (auxiliary input) jack
20. Hands-free Microphone
21. Reset button

# GENERAL OPERATION

---

## Turn Unit On/Off

- Press any button on the front panel or on the remote control to turn on the unit.
- Press and hold the power (⏻) button on the front panel or briefly press the power (⏻) button on the remote control to turn the unit on or off.

## Adjust Volume (VOL)

Rotate the **VOL** knob on the front panel or press the **VOL+ ▲** / **VOL- ▼** button on the remote control to increase or decrease the volume level.

## Adjust Menu Options (SEL)

- Press the **SEL** button on the front panel or on the remote control repeatedly to cycle through the following adjustable audio functions: BASS, TREBLE, BALANCE, FADER, EQ OFF/ CLASS/ ROCK/POP/ FLAT, LOUD ON/OFF, DX/LOC, STEREO/MONO, CLOCK 12/24, AREA US/EU, AUTO/ BLUE/RED/CYAN/GREEN/ PURPLE / YELLOW/WHITE.

- Rotate the **VOL** knob on the front panel or press the **VOL+ ▲** / **VOL- ▼** button on the remote control to adjust the selected item.

- BASS/TREBLE: -7, -6, ~, 1, 0, +1, ~, +6, +7

- BALANCE: L7, L6, ~, L1, 0, R1, ~, R6, R7

- FADER: R7, R6, ~, R1, 0, F1, ~, F6, F7

- EQ(Equalizer) Setting: OFF, CLASS, ROCK, POP, FLAT

- Loudness: LOUD ON/OFF

- DX/LOCAL: Enables or disables the local broadcast mode (LOCAL).

- Stereo/Mono: Switches between MONO and STEREO reception mode for radio frequencies.

- CLOCK 12/24: Select between 12 hours and 24 hours display.

Note: If 12 hour display is selected, AM= Morning; PM= Afternoon

- AREA US/EU: This car radio is equipped the USA / Europe frequency.  
Rotate the volume knob to switch between USA and Europe frequency.  
The system will change the frequency setting in about 3 seconds.

- 7 color-changing illumination in buttons:

This car radio device is equipped 7 color-changing illumination in buttons.

The illumination color can be preset Auto(color automatically change one by one), Blue, Red, Cyan, Green, Purple, Yellow, White.

- Rotate the **VOL** knob on the front panel or press the **VOL+ ▲** / **VOL- ▼** button on the remote control to adjust the selected item.

## Set the Clock (CLK)

1. To display clock time, press the **CLK** button.
2. To set clock time, press and hold the **CLK** button and the hour will flash.
3. Press the **◀** or **▶** button on the front panel or on the remote control to adjust the hour.
4. Press the **CLK** button and the minutes will flash.
5. Press the **◀** or **▶** button on the front panel or on the remote control to adjust the minute.

# GENERAL OPERATION (CONT.)

---

## **Change the Source (SRC)**

Press the **SRC** button to switch between RADIO, BT(Bluetooth), USB(with USB device inserted) and AUX-IN(auxiliary input) modes.

## **Mute on/off**

In power on mode, briefly press the **MUTE** button to toggle mute on or off. The muted state will be also released when the volume knob is used.

## **Loudness on/off**

Press the **LOUD** button on the remote control to turn on the loudness to reinforce the output of bass frequencies, press again to turn it off.

## **Preset EQ (Equalizer)**

Press the **EQ** button to toggle between EQ OFF, CLASS, ROCK, POP, FLAT.

## **USB port**

The USB port of this car radio is designed for media playback from flash memory devices and charging for iPhone / android mobile phone. The charging current consumption is 1 ampere.

## **Hands-free Microphone**

To receive your voice when you calling by using this bluetooth handsfree system.

## **Aux input connector**

The 3.5mm auxiliary input stereo connection is designed for deiveces with 3.5mm line-out or headphone output.

## **Reset System (Reset)**

The **RESET** button is used to reset all parameters to factory default settings.

This function may be used when the LCD does not display normally or sound is distorted, or when any of controls are disabled. To reset your system, use a thin object with a pointed end to depress the **RESET** button.



# RADIO OPERATION

---

## Switch Between USA area and Europe area Frequency

In radio mode, press the **VOL** button to enter the switch state of the US(USA) and EU(europe) frequency, then rotate it to switch between US(USA) and EU(europe) frequency. The system will change the frequency setting in about 3 seconds.

## Change Bands (BAND)

Press the **BAND** button to switch between the FM1, FM2, FM3, AM1 and AM2 bands. Each band stores up to six preset stations.

## Manual Tuning (◀◀ / ▶▶)

Press and hold the ▶▶ or ◀◀ button on the front panel or on the remote control to enter manual tuning mode. In manual tuning mode, press the ▶▶ or ◀◀ button to move the radio frequency number up or down one step.

## Auto Seek Tuning (◀◀ / ▶▶)

In standby mode or while not in manual tuning mode, quickly press the ▶▶ or ◀◀ button to move to the next/previous available station automatically.

## To Store / Recall Preset Stations

The radio can be stored 6 preset stations for each band (FM1, FM2, FM3, AM1 and AM2) for a total of 30 preset stations.

### To memorize a station:

- Turn the radio on and select the desired band and station.
- Select a station by ▶▶ or ◀◀ button.
- Press and hold the desired preset button (numbered 1-6 on the face of the radio) for more than 2 seconds to save the station to that preset number.

### - To recall a preset station:

- Select the desired band.
- Briefly press a preset button (numbered 1-6) to recall the corresponding preset station.

## Automatic Store station/ Preset station scan (AMS)

Press and hold the **AMS** button for more than 2 seconds to select six strong stations and store them in the current band. The radio will automatically scan the current frequency and enter the six strongest stations into the preset memory positions for that band.

Briefly press the **AMS** button on the front panel or on the remote control to recall each preset station that saved in the memories in each band.

## LOCAL/DX

In urban areas, most stations are strong enough and "LOCAL ON" mode should be selected. Switch to LOCAL OFF mode to search for stations with weaker signals.

Press the **LOC** button on the remote control to choose local or distant reception mode.

## STEREO/MONO

FM station is received in stereo mode. However, if the signal is weak or reception is not as good as you would like, switching to MONO mode usually improves the overall sound quality.

Press the **ST** button on the remote control to choose FM STEREO or MONO audio effect.

# USB OPERATION

---

## To insert USB

- To play files in a USB device, open the USB port cover, then insert a USB storage device into the USB port. Playback will begin automatically.

## Eject USB

- To eject a USB device, press the **▶||** button to stop playback, then remove the USB device.

## Play/Pause

Press the **▶||** (play/pause) button to pause or resume playback.

## Next/Previous Track

- To play the next track, press the **▶▶** button.
- To play the previous track, press the **◀◀** button.

## Fast Forward/Backward

- To fast forward, press and hold the **▶▶** button.
- To fast backward, press and hold the **◀◀** button.

## Introduction Scan

Press the **INT** button to play the first 10 seconds of each track, press again to stop the introduction scan, and play the current track.

## Repeating the track

Press the **RPT** button to toggle between RPT ALL (Play all track), RPT FLR (Continuously repeats all tracks in current folder) and RPT ONE (Continuously repeats current track).

## Playing all tracks in random

Press the **RDM** button to play all tracks in random order, press again to cancel this function.

## Track/Folder Navigation

- During USB mode, press the **5/-10** button to go backward 10 tracks.  
Press the **6/+10** button to jump forward 10 tracks.
- During USB mode, press and hold the **5/-10** button to go back the previous folder.  
Press and hold the **6/+10** button to go to the next folder.  
You can repeat this function depending on the number and level of folders.
- These buttons have no this function if the USB device has no folders.

## Select the track or file for playback in MP3 format

- a) Press the **AMS** button to enter track search mode. The "TRK0000" will appear on the display.
- b) Turn the volume control to select the "first number". Then press the **◀◀** button to move the "first number" to the left and enter the next number.
- c) When the desired track number appears, confirm your selection by pressing SEL button.

## AUXILIARY INPUT OPERATION

---

This car radio is equipped an external auxiliary input jack (3.5mm) on the front panel, it is compatible with audio output from an MP3 music player.

If you have plugged such a player into the AUX IN jack with a audio cable.

Press the **SRC** button to switch to the AUX input mode, then you can listen to music from external devices.

# BLUETOOTH OPERATION



---

## Pair and Connect

Prior to using the Bluetooth device as a handsfree system for a Bluetooth-enabled mobile phone for the first time, you must pair and connect the two devices as follows:

1. In any mode, prior to pairing and connecting, the BT logo in the LCD indicating that no device is connected. To begin pairing, enable BT mode on your mobile phone.
2. When the phone finds the car audio system, the "BOSS 820BRGB" name will be displayed.
3. Choose the "BOSS 820BRGB" from the device list to pair and connect with the car audio system. Upon confirming, the BT logo will stop flashing.
4. When pairing is complete, the mobile phone audio will automatically transfer to the car audio system whenever a call is made or received, or when the mobile phone plays music.

## Make a Call

- To make a call, dial the call directly from the paired mobile phone.
- To make a call with this bluetooth handsfree system:
  - a) When linking up the Bluetooth-enabled mobile phone to this bluetooth handsfree system, press the  button to access the dial telephone number mode, then press the "0~9", \* and # button on remote control to input the telephone number, and the entered number will be shown on the LCD display.
  - b) If a number has been incorrectly inputted, press the **DEL** button or  button to delete it.
  - c) Press the  button to make outgoing call.

## Redial Last Dialed Number

Press and hold the  button on the control panel to redial the last dialed phone number.

## Answer a Call

- When the mobile phone is called, the incoming telephone number displays on the LCD.
- To receive the call, press the  button on the control panel.

## Reject a Call

To reject the call, press the  button on the control panel.

## End a Call

To end an active call, press the  button.

## Switch Audio Between Car Audio and mobile Phone



During a call, press the **VOL** knob/button to switch the audio source from the car audio system back to your mobile phone.

## Adjust Call Volume

- During a call, use **VOL** knob or **VOL+**  / **VOL-**  button to adjust the call volume level.
- Use the **MUTE** button to mute sound.

## Audio Streaming (A2DP)

The unit supports A2DP (advanced audio distribution profile) wireless streaming audio from your Bluetooth mobile device directly to your head unit. You can also control your music from the front panel of the head unit using AVRCP (audio video remote control profile).

1. After pairing, connecting and enabling streaming audio from a compatible mobile device, press the **SRC** button to enter BT mode and display pause in the LCD display.
2. When a mobile device is paired, music played through that device will automatically be heard through the car audio system and display A2DP in the LCD display.
3. Press the  or  button to play the next or previous on the mobile phone.
4. Press the  button to pause or resume music playback.

# REMOTE CONTROL

## Remove Insulating Sheet

The remote control comes with an insulating sheet attached to the underside of the remote control, as illustrated on the right. The remote control will not work until the insulating sheet is removed.

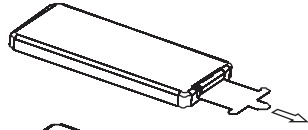

## Replace Lithium Battery Cell

1. When the lithium cell battery becomes weak, replace it as illustrated on the right.
2. Press and hold the movable block in the direction indicated by arrow 1. At the same time, pull the cell holder out of the remote control in the direction indicated by arrow 2.
3. Replace the old cell with a new one, making sure the (+) polarity is facing upward.
4. Re-insert the cell holder into the remote control.

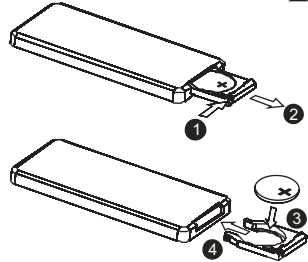

- Cell leakage may cause damage to the remote control.
- Do not throw cells into fire as this may cause an explosion.
- Keep battery cells out of reach of children.

## Remote Control Operation

Position the emitting window of the remote control toward the sensor window of the unit.

- The operation angle for front panel remote control reception is about 30 degrees.
- The distance between the emitting window of the remote control and the sensor window of the unit should remain less than 5 meters.

## Button Names and Locations

1. Power on/off button
2. VOL+/VOL-(volume increase/decrease) button
3. Band button, ANSWER (answer call) button
4. PREV: tune down, seek down; Track down, fast reverse
5. SEL(selection) button
6. NEXT: tune up, seek up; Track up, fast forward
7. Mute button, DEL(Delete) button
8. CLK(clock setting) button, END (end call) button
9. PAUSE button, preset station 1 button, keypad 1
10. INT(intro) button, preset station 2 button, keypad 2
11. RPT(repeat) button, preset station 3 button, keypad 3
12. RDM (random), preset station 4 button, keypad 4
13. -10(previous 10 tracks), preset station 5 button, keypad 5
14. +10(next 10 tracks), preset station 6 button, keypad 6
15. ST (stereo) button, keypad 7
16. LOUD(loudness) button, keypad 8
17. AMS (automatic music search) button, keypad 9
18. SRC(Source) button, keypad \*
19. EQ(Equalizer) button, keypad 0
20. LOC (local)/DX button, keypad #

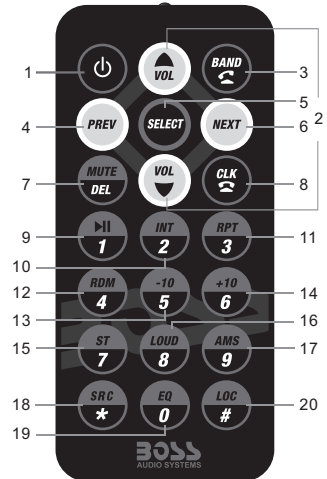

Note: When using the remote control for the first time, you must pull out the protective plastic tab from the battery compartment found on the back of the remote control.

# SPECIFICATIONS

---

## General

Chassis Dimensions.....	178(W) x 125(D) x 100(H) mm
Power Supply Requirement .....	DC 12V
Current Consumption .....	15A (max.)
Maximum Power Output .....	60W x 4CH

## Radio

### FM

USA/ Europe Frequency Range.....	87.5 - 107.9 MHz (200KHz/Step)
	87.5 - 108.0 MHz(50KHz/Step)
Usable Sensitivity .....	30 dBu
I.F. Frequency .....	10.7 MHz

### AM

USA/ Europe Frequency Range.....	530 - 1710KHz (10KHz/Step)
	522 - 1620 KHz (9KHz/Step)
Usable Sensitivity .....	20 dBu
I.F. Frequency .....	450 KHz

### USB

Usable Audio Formats .....	MP3/WMA
USB Port Type.....	2.0
USB Charging.....	5V/1A
Pre-amp Output .....	Front and Rear
Frequency Response .....	20 Hz - 20 KHz
S/N Ratio .....	60dB

### BT

BT Profile supports .....	A2DP, AVRCP, HFP
Range of frequency .....	2.4GHz spectrum

# TROUBLESHOOTING

---

If you suspect something is wrong, immediately switch power off. Do not use the unit in abnormal condition, for example without sound, or with smoke or foul smell, can cause fire or electric shock.

Immediately stop using it and call the store where you purchased it. Never try to repair the unit by yourself because it is dangerous to do so.

## ■ General

### 1) Car's engine switch is not on.

Turn you car's key to ACC or ON.

### 2) Cable is not correctly connected.

Check the connection.

### 3) Fuse is burnt.

Replace fuse.

### 4) Volume is in mute or minimum.

Check volume or mute on/off, adjust volume to a desired level.

### 5) Sound skips.

The installation angle is more than 30°. Adjust the installation angle less than 30°.

### 6) The operation keys do not work.

The built-in micro- computer is not operating properly due to noise. Press the RESET button to restore the program to zero.

## ■ Radio

### 1) Much noise in broadcasts.

Station or signal is too weak. Select other stations of stronger signal level.

### 2) The antenna cable is not connected.

Insert the antenna cable firmly into the antenna socket of this car radio.

### 3) Preset station is reset.

Battery cable is not correctly connected. Connect the battery cable to the terminal that is always live.

## ■ USB

### USB is connecting but no sound

a) USB connection is not good. Take it out and insert again.

b) USB is damaged or no music file inside. Change to another USB, or record music inside it.

# USER'S MANUAL

820BRGB

BLUETOOTH® | MP3-COMPATIBLE DIGITAL MEDIA AM/FM RECEIVER



BOSS Audio Systems  
3451 Lunar Court • Oxnard, CA 93030

[www.bossaudio.com](http://www.bossaudio.com)

800-999-1236 US Toll-free

805-751-4853 Customer Service

Tech Support: [www.bossaudio.com/support/technical-support](http://www.bossaudio.com/support/technical-support)



0518

iPod® and iPhone® are trademarks of Apple, Inc. registered in the U.S. and other countries. BOSS Audio Systems is not affiliated with Apple, Inc. The Bluetooth® word mark and logos are registered trademarks owned by Bluetooth SIG, Inc. and any use of such marks by BOSS Audio Systems is under license. Other trademarks and trade names are those of their respective owners.