



# **TURBO HD**

## **H1T Series Bullet Camera**

### User Manual

#### **User Manual**

Thank you for purchasing our product. If there are any questions, or requests, do not hesitate to contact the dealer.

This manual applies to the models below:

Type	Model
Type I Camera	DS-2CE16H1T-IT(E)
Type II Camera	DS-2CE16H1T-IT1(E)
	DS-2CE16H1T-IT3(E)
	DS-2CE16H1T-IT5(E)

This manual may contain several technical incorrect places or printing errors, and the content is subject to change without notice. The updates will be added to the new version of this manual. We will readily improve or update the products or procedures described in the manual.

## Regulatory Information

### FCC Information

Please take attention that changes or modification not expressly approved by the party responsible for compliance could void the user's authority to operate the equipment.

**FCC compliance:** This equipment has been tested and found to comply with the limits for a Class A digital device, pursuant to part 15 of the FCC Rules. These limits are designed to provide reasonable protection against harmful interference when the equipment is operated in a commercial environment. This equipment generates, uses, and can radiate radio frequency energy and, if not installed and used in accordance with the instruction manual, may cause harmful interference to radio communications. Operation of this equipment in a residential area is likely to cause harmful interference in which case the user will be required to correct the interference at his own expense.

### FCC Conditions

This device complies with part 15 of the FCC Rules. Operation is subject to the following two conditions:

1. This device may not cause harmful interference.
2. This device must accept any interference received, including interference that may cause undesired operation.

### EU Conformity Statement



This product and - if applicable - the supplied accessories too are marked with "CE" and comply therefore with the applicable harmonized European

standards listed under the Low Voltage Directive 2014/35/EU, the EMC Directive 2014/30/EU.

2012/19/EU (WEEE directive): Products



marked with this symbol cannot be disposed of as unsorted municipal waste in the European Union. For proper recycling, return this product to your local supplier upon the purchase of equivalent new

equipment, or dispose of it at designated collection points. For more information see: [www.recyclethis.info](http://www.recyclethis.info).

2006/66/EC (battery directive): This



product contains a battery that cannot be disposed of as unsorted municipal waste in the European Union. See the product documentation for specific battery

information. The battery is marked with this symbol, which may include lettering to indicate cadmium (Cd), lead (Pb), or mercury (Hg). For proper recycling, return the battery to your supplier or to a designated collection point. For more information see: [www.recyclethis.info](http://www.recyclethis.info).

### Industry Canada ICES-003 Compliance

This device meets the CAN ICES-3 (A)/NMB-3(A) standards requirements.

### Warning

This is a class A product. In a domestic environment this product may cause radio interference in which case the user may be required to take adequate measures.

## Safety Instruction

These instructions are intended to ensure that user can use the product correctly to avoid danger or property loss.

The precaution measure is divided into “Warnings” and “Cautions”.

**Warnings:** Serious injury or death may occur if any of the warnings are neglected.

**Cautions:** Injury or equipment damage may occur if any of the cautions are neglected.

	
<b>Warnings</b> Follow these safeguards to prevent serious injury or death.	<b>Cautions</b> Follow these precautions to prevent potential injury or material damage.



### Warnings

- In the use of the device, you must be in strict compliance with the electrical safety regulations of the nation and region.
- Input voltage should meet both the SELV (Safety Extra Low Voltage) and the Limited Power Source with 12 VDC according to the IEC60950-1 standard. Refer to technical specifications for detailed information.
- Do not connect multiple devices to one power adapter to avoid over-heating or a fire hazard caused by overload.
- Make sure that the plug is firmly connected to the power socket.
- Make sure that the device is firmly fixed if wall mounting or ceiling mounting is adopted.
- If smoke, odor or noise rise from the device, turn off the power at once and unplug the power cord, and then contact the service center.
- Never attempt to disassemble the camera by unprofessional personal.



### Cautions

- Do not drop the camera or subject it to physical shock.
- Do not place the camera in extremely hot, cold (the operating temperature shall be  $-40^{\circ}\text{C}$  to  $60^{\circ}\text{C}$ ), dusty or damp locations, and do not expose it to high electromagnetic radiation.
- Do not touch sensor modules with fingers.
- If cleaning is necessary, use clean cloth with a bit of ethanol and wipe it gently.
- Do not aim the camera at the sun or extra bright places.
- The sensor may be burned out by a laser beam, so when any laser equipment is in using, make sure that the surface of sensor will not be exposed to the laser beam.
- Do not expose the device to high electromagnetic radiation or extremely hot, cold, dusty or damp environment.
- To avoid heat accumulation, good ventilation is required for the operating environment.

- Keep the camera away from liquid while in use for non-water-proof device.
- While in delivery, the camera shall be packed in its original packing, or packing of the same texture.

## Mark Description

Table 0-1 Mark Description

Mark	Description
---	DC Voltage

# 1 Introduction

## 1.1 Product Features

The camera is applicable for both indoor and outdoor conditions, and the application scenarios include road, warehouse, underground parking lot, bar, etc..

The main features are as follows:

- High performance CMOS sensor
- Low illumination, 0.01 Lux@(F1.2, AGC ON), 0 Lux with IR
- IR cut filter with auto switch
- OSD menu with configurable parameters
- Auto white balance
- internal synchronization
- SMART IR mode
- PoC (with -E)
- 3-axis adjustment

## 1.2 Overview

This manual applies to two types of bullet cameras. The overviews of each type are shown in the figures below.

### 1.2.1 Overview of Type I Camera

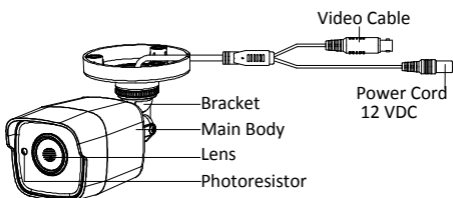

Figure 1-1 Overview of Type I Camera

### 1.2.2 Overview of Type II Camera

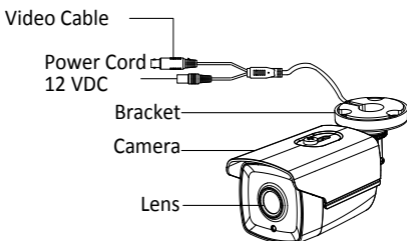

Figure 1-2 Overview of Type II Camera

## 2 Installation

### Before you start:

- Make sure that the device in the package is in good condition and all the assembly parts are included.
- Make sure that all the related equipment is power-off during the installation.
- Check the specification of the products for the installation environment.
- Check whether the power supply is matched with your power output to avoid the damage.
- Make sure the wall is strong enough to withstand three times the weight of the camera and the bracket.
- If the wall is cement, insert expansion bolts before installing the camera. If the wall is wooden, use self-tapping screws to secure the camera.
- If the product does not function properly, contact your dealer or the nearest service center. Do NOT disassemble the camera for repair or maintenance by yourself.

### 2.1 Installation of Type I Camera

#### 2.1.1 Ceiling/Wall Mounting without Junction Box

##### Steps:

1. Paste the drill template (supplied) to the place where you want to install the camera.
2. Drill the screw holes and the cable hole (optional) in the ceiling/wall according to the drill template.

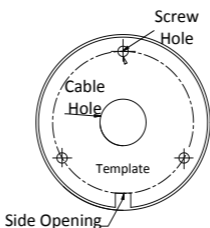

Figure 2-1 Drill Template

##### Note:

Drill the cable hole, when adopting the ceiling outlet to route the cable.

3. Attach the bracket to the ceiling/wall and secure the camera with supplied screws.

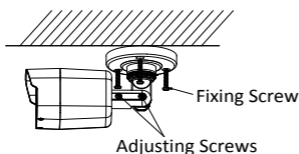

Figure 2-2 Fix the Camera to the Ceiling

##### Note:

- The supplied screw package contains self-tapping screws, and expansion bolts.
  - For cement wall/ceiling, expansion bolts are required to fix the camera. For wooden wall/ceiling, self-tapping screws are required.
4. Route the cables through the cable hole, or the side opening.

5. Connect the corresponding power cord, and video cable.
6. Power on the camera to check whether the image on the monitor is gotten from the optimum angle. If not, adjust the camera according to the figure below to get an optimum angle.

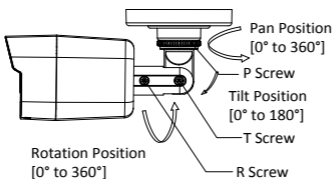

Figure 2-3 3-axis Adjustment

- 1). Loosen the P screw to adjust the pan position [0° to 360°]. Tighten the screw after completing the adjustment.
- 2). Loosen the T screw to adjust the tilt position [0° to 180°]. Tighten the screw after completing the adjustment.
- 3). Loosen the R screw and rotate the camera [0° to 360°]. Tighten the screw after completing the adjustment.

### 2.1.2 Ceiling/Wall Mounting with Junction Box

#### **Before you start:**

You need to purchase a junction box separately.

#### **Steps:**

1. Paste the drill template on the ceiling/wall.
2. Drill screw holes and the cable hole in the ceiling/wall according to the holes of the drill template.

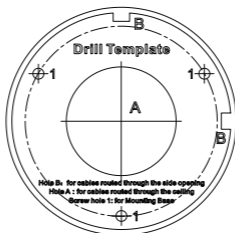

Figure 2-4 Drill Template of Junction Box

3. Take apart the junction box, and align the screw holes of the bullet camera with those on the Junction box' cover.
4. Fix the camera on the junction box's cover with supplied screws.

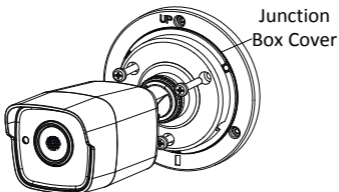

Figure 2-5 Fix the Camera on the Junction Box's Cover

5. Attach the junction box body to the ceiling/wall by aligning the screw holes of the junction box.
6. Secure the junction box's body with supplied screws on the ceiling/wall.

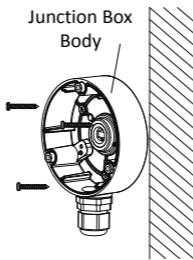

Figure 2-6 Fix the Junction Box to the Wall/Ceiling

7. Route the cables through the bottom cable hole, or the side cable hole of the junction box.
8. Combine the junction box cover with its body.

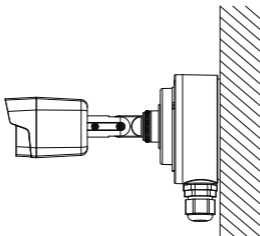

Figure 2-7 Fix the Junction Box Cover back to its Body

9. Repeat the step 5 and 6 of 2.1.1 *Ceiling/Wall Mounting without Junction Box* to complete the installation.

## 2.2 Installation of Type II Camera

### 2.2.1 Ceiling/Wall Mounting without Junction Box

#### Steps:

1. Paste the drill template (supplied) to the place where you want to install the camera.
2. Drill the screw holes according to the drill template, and the cable hole (optional) on the ceiling.

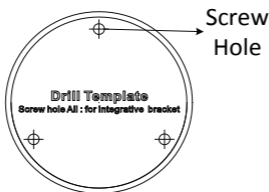

Figure 2-8 Drill Template

#### **Note:**

Drill the cable hole in the center of the drill template, when adopting ceiling outlet to route the cable.

3. Route the cables through the cable hole (optional) or the side opening.
4. Fix the camera to the ceiling with supplied screws.

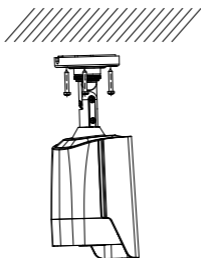

Figure 2-9 Fix the Camera to the Ceiling

**Note:**

- The supplied screw package contains self-tapping screws, and expansion bolts.
  - For cement wall/ceiling, expansion bolts are required to fix the camera. For wooden wall/ceiling, self-tapping screws are required.
5. Connect the corresponding power cord, and video cable.
  6. Power on the camera to check whether the image on the monitor is gotten from the optimum angle. If not, adjust the surveillance angle.

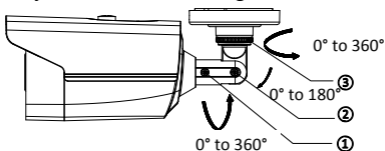

Figure 2-10 3-Axis Adjustment

- 1). Loosen the No.1 adjusting screw to adjust the pan position [0° to 360°]. Tighten the No.1 adjusting screw.
- 2). Loosen the No.2 adjusting screw to adjust the tilting position [0° to 180°]. Tighten the No. 2 adjusting screw.
- 3). Loosen the No.3 adjusting screw to adjust the rotation position [0° to 360°]. Tighten the No.3 adjusting screw.

### 2.2.2 Ceiling/Wall Mounting with Junction Box

**Before you start:**

You need to purchase a junction box separately.

**Steps:**

1. Paste the drill template on the ceiling/wall.
2. Drill screw holes and the cable hole (optional) in the ceiling/wall according to the holes of the drill template.

**Note:**

Drill the cable hole, when adopting ceiling outlet to route the cable.

3. Take apart the junction box, and align the screw holes of the bullet camera with those on the Junction box's cover.
4. Fix the camera on the junction box's cover with three supplied screws.
5. Secure the junction box's body with supplied screws on the ceiling/wall.



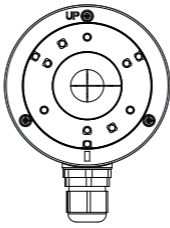

Figure 2-11 Install the Junction Box

6. Route the cables through the bottom cable hole, or the side cable hole of the junction box.
7. Combine the junction box cover with its body with supplied screws on the junction box's cover.

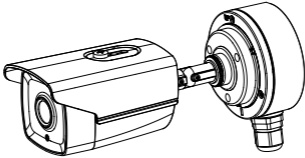



Figure 2-12 Combine the Junction Box's Cover with its Body

8. Repeat the step 5 and 6 of *2.2.1 Ceiling/Wall Mounting without Junction Box* to complete the installation.

## 3 Menu Description

### Purpose:

Call the menu by clicking button  on the PTZ Control interface, or call preset No.95.

### Steps:

1. Connect the camera with the TVI DVR, and the monitor, shown as the figure 3-1.



Figure 3-1 Connection

2. Power on the analog camera, TVI DVR, and the monitor to view the image on the monitor.
3. Click PTZ Control to enter the PTZ Control interface.
4. Call the camera menu by clicking  button, or call preset No. 95.

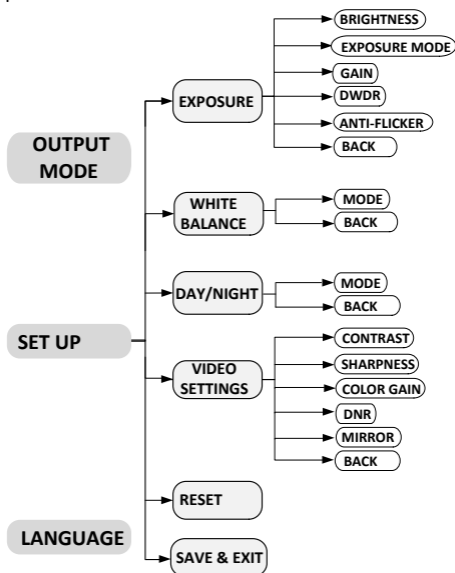

Figure 3-2 Main Menu Overview

5. Click the direction arrow to control the camera.
  - 1). Click up/down direction button to select the item.
  - 2). Click Iris + to confirm the selection.
  - 3). Click left/right direction button to adjust the value of the selected item.

### 3.1 OUTPUT MODE

In the OUTPUT MODE submenu, you can set RESOLUTION, FRAME RATE, and NTSC/PAL.

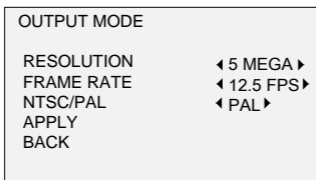

Figure 3-3 OUTPUT MODE

## RESOLUTION

Resolution refers to the number of the pixels contained in an image. You can set the resolution as 5 megapixels, 4 megapixels or 1080p. The higher the value, the finer the image is.

## FRAME RATE

Frame rate refers to the number of image output in 1 second.

When the resolution is set as 5 megapixels, you are allowed to set the frame rate as 20 fps or 12.5 fps. When the resolution is set as 4 megapixels, you are allowed to set the frame rate as 25 fps or 30 fps.

## NTSC/PAL

### PAL

(Phase Alternating Lines) is a color encoding system for analog television used in broadcast television systems in most countries.

### NTSC

(National Television System Committee) is the analog television system that is used in most of North America, parts of South America, Myanmar, South Korea, etc.

## 3.2 LANGUAGE

Supports English, and Chinese.

## 3.3 EXPOSURE

Exposure describes the brightness-related parameters, which can be adjusted by **BRIGHTNESS**, **EXPOSURE MODE**, **GAIN**, **DWDR** and **ANTI-FLICKER**.

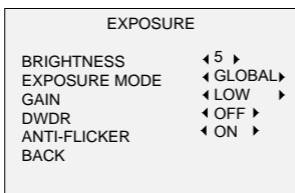

Figure 3-4 AE

## BRIGHTNESS

Brightness refers to the brightness of the image. You can set the brightness value from 1 to 10 to darken or brighten the image. The higher the value, the brighter the image is.

## EXPOSURE MODE

You can set the **EXPOSURE MODE** as **GLOBAL**, or **BLC**.

- **GLOBAL**

GLOBAL refers to the normal exposure mode which performs exposure according to the whole image brightness.

- **BLC (Backlight Compensation)**

BLC (Backlight Compensation) compensates light for the front object to make it clear, but this may cause the

over-exposure of the background, where the light is strong.

When BLC is selected as the exposure mode, the BLC level can be adjusted from 0 to 8.

### **GAIN**

It optimizes the clarity of the image in poor light conditions. The **GAIN** level can be set as **HIGH**, **MEDIUM**, or **LOW**. Select **OFF** to disable the **GAIN** function.

#### **Note:**

The noise will be amplified, when the GAIN is on.

### **DWDR (Digital Wide Dynamic Range)**

The **DWDR** helps the camera provide clear images even under backlight circumstances. When both very bright and very dark areas simultaneously exist in the image, **DWDR** balances the brightness level of the whole image to provide clear images with details.

Set the **DWDR** as ON to improve the image quality under the backlight environment.

Set the **DWDR** as OFF to disable the function.

### **ANTI-FLICKER**

Set the **ANTI-FLICKER** as **ON** to prevent the image from flicker.

## **3.4 WHITE BALANCE**

White balance, the white rendition function of the camera, is to adjust the color temperature according to the environment. It can remove unrealistic color casts in the image. You can set **WB** mode as **ATW**, or **MWB**.

### **ATW (Aoto Tracking White Balance)**

Under **ATW** mode, white balance is being adjusted automatically according to the color temperature of the scene illumination.

### **MWB (Manual White Balance)**

You can set the **R GAIN/B GAIN** value from 1 to 255 to adjust the shades of red/blue color of the image.

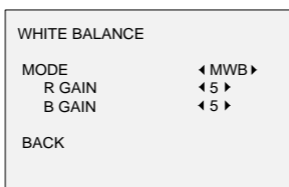

Figure 3-5 MWB MODE

## **3.5 DAY/NIGHT**

**COLOR**, **BW** (Black White), and **AUTO** are selectable for DAY/NIGHT switch.

### **COLOR**

The image is colored in day mode all the time.

### **B/W**

The image is black and white all the time, and the IR LED turns on in the poor light conditions.

### **AUTO**

Automatically switch Color or BW (Black and White) according to actual scene brightness.

You can turn on/off the **INFRARED** and set the value of **SMART IR** in this menu.

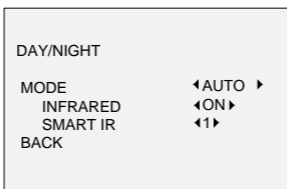

Figure 3-6 DAY NIGHT

● **INFRARED**

You can turn on/off the IR LED to meet the requirements of different circumstances.

● **SMART IR**

The **Smart IR** function is used to adjust the light to its most suitable intensity, and prevent the image from over exposure. The **SMART IR** value can be adjusted from 1 to 3. The higher the value, the more obvious effects are.

### 3.6 VIDEO SETTINGS

Move the cursor to **VIDEO SETTINGS** and click Iris+ to enter the submenu. **CONTRAST**, **SHARPNESS**, **COLOR GAIN**, **DNR**, and **MIRROR** are adjustable.

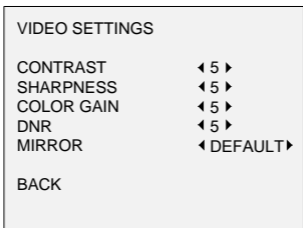

Figure 3-7 VIDEO SETTING

**CONTRAST**

This feature enhances the difference in color and light between parts of an image. You can set the **CONTRAST** value from 1 to 10.

**SHARPNESS**

Sharpness determines the amount of detail an imaging system can reproduce. You can set the **SHARPNESS** value from 1 to 10.

**COLOR GAIN**

Adjust this feature to change the saturation of the color. The value ranges from 1 to 10.

**DNR (Digital Noise Reduction)**

The DNR function can decrease the noise effect, especially when capturing moving images in low light conditions and delivering more accurate and sharp image quality. You can set the **DNR** value from 1 to 10.

**MIRROR**

**DEFAULT**, **H**, **V**, and **HV** are selectable for mirror.

**DEFAULT**: The mirror function is disabled.

**H**: The image flips 180° horizontally.

**V**: The image flips 180° vertically.

**HV**: The image flips 180° both horizontally and vertically.

### 3.7 RESET

Reset all the settings to the default.

### **3.8 SAVE & EXIT**

Move the cursor to **SAVE & EXIT** and click Iris+ to save the setting and exit the menu.