

Bunk Bed



IMPORTANT

Carefully remove all the parts from the carton and place them individually on a soft cloth to prevent scratches or other damage.

Carefully and strictly follow these assembly instructions to ensure a completed product as designed.

Do not use power tools above 8 volts to assemble.

Part List

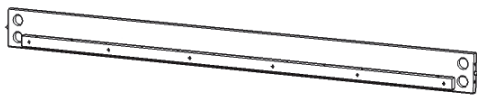

E.
Lower Panel
2 pcs.

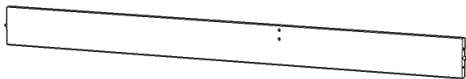

F.
Upper Front Panel
1 pc.

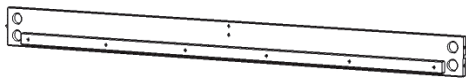

G.
Upper Back Panel
1 pc.

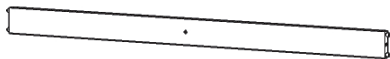

H.
Front Guardrail
2 pcs.

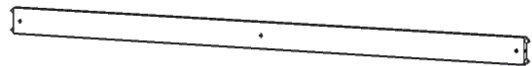

I.
Back Guardrail
2 pcs.



J.
Support
2 pcs.



K.
Support
1 pc.

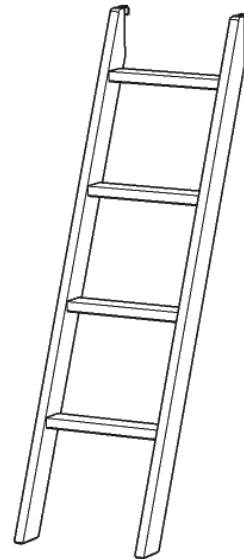

L.
Ladder
1 pc.

Hardware List

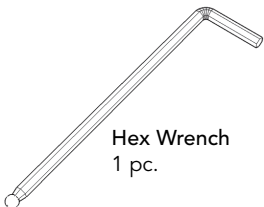

Hex Wrench
1 pc.



Small Hex Wrench
1 pc.

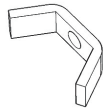

Angled Washer
16 pcs. (+1 extra)



Cross Dowel
8 pcs. (+1 extra)



M8x25
Wood Screw
56 pcs. (+1 extra)

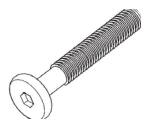

M6x40
Head Cap Bolt
16 pcs. (+1 extra)



M6x30
Head Cap Bolt (short)
10 pcs. (+1 extra)

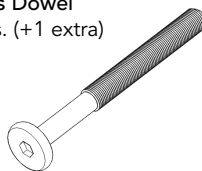

M6x90
Head Cap Bolt (medium)
2 pcs. (+1 extra)

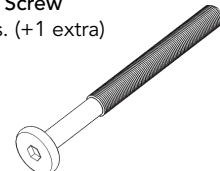

M6x105
Head Cap Bolt (long)
6 pcs. (+1 extra)



Metal Pin
4 pcs.

Cartons 20 05533 0541 and 0542 are also needed for assembly.

Tool(s) required for assembly: Phillips screwdriver, Level

Home Styles Customer Service: www.homestyles-furniture.com,
 servicedesk@homestyles-furniture.com, 888-680-7460, 877-831-0319

Assembly Instructions 2/6

IMPORTANT

- Use a soft cloth between these parts and the floor.
- Do not use power tools above 8 volts to assemble.
- Do not tighten all the bolts until each part is properly assembled.
- The unit must be level to work properly. Use the included adjustable levelers to level.
- Keep Hex Wrench as the bolts may need to be tightened in the future.

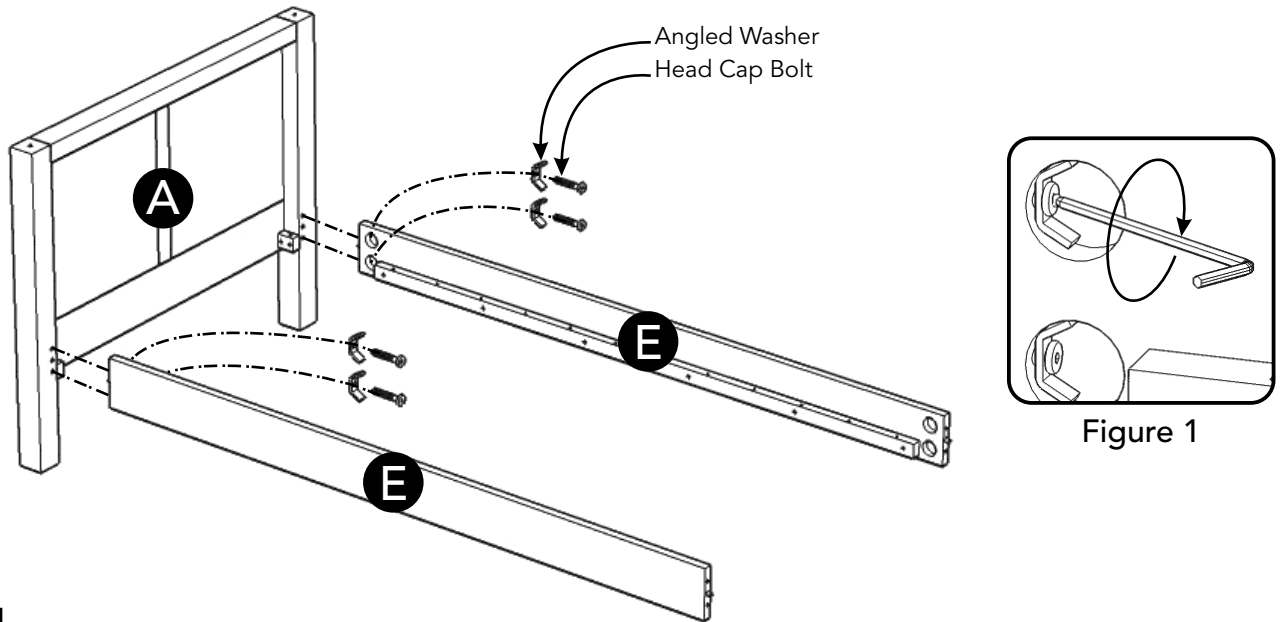

STEP 1

Attach Lower Panels (E) to Lower End Panel (A) with Angled Washers and Head Cap Bolts, tightening bolts only halfway. (See Figure 1)

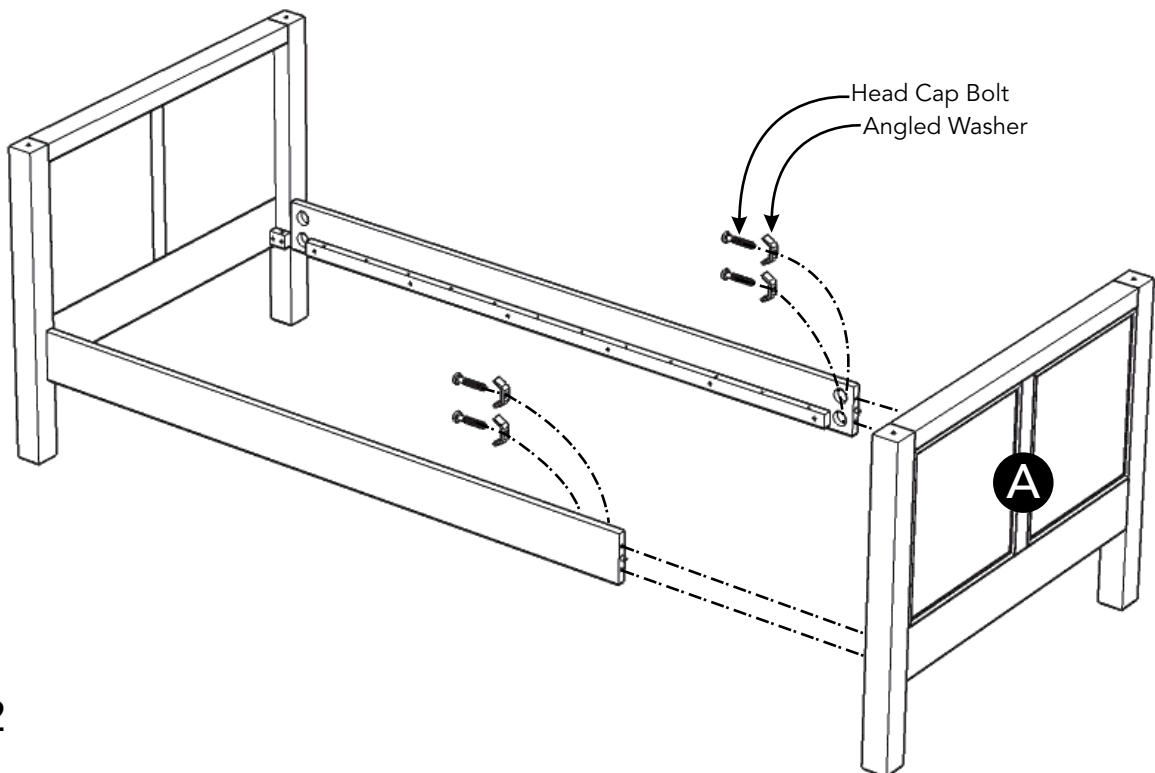

STEP 2

Attach Lower End Panel (A) to unit with Angled Washers and Head Cap Bolts, tightening bolts only halfway.

Tighten all bolts used in Steps 1 and 2.

Assembly Instructions 3/6

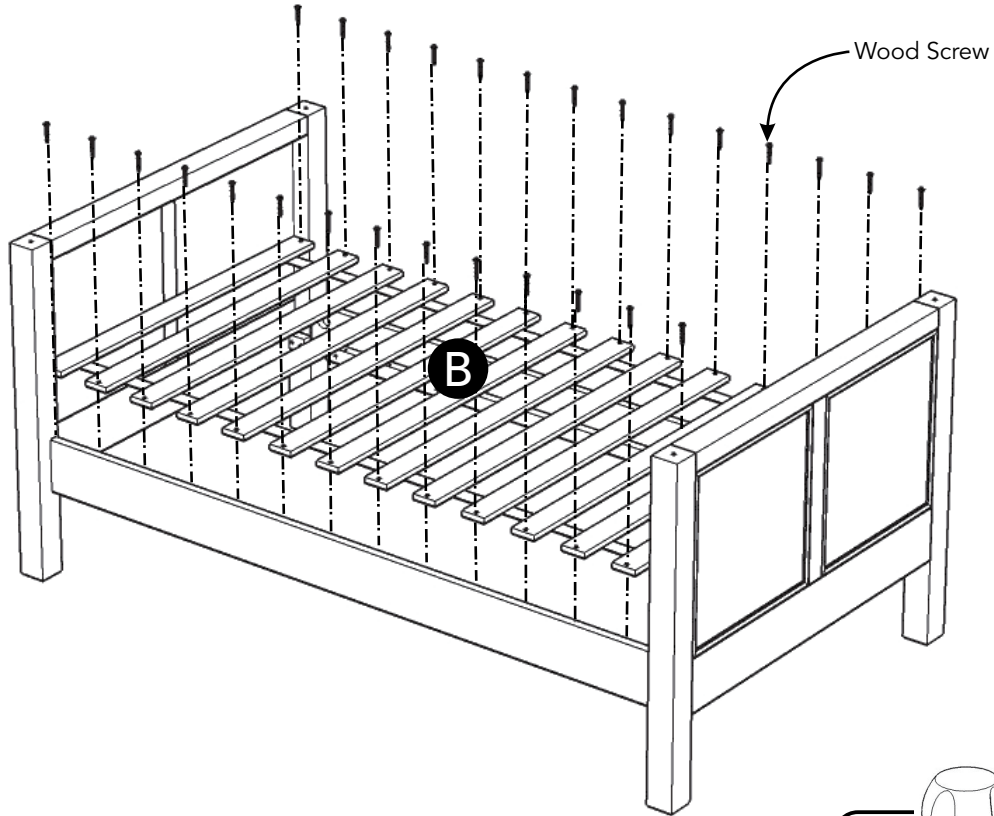

STEP 3

Attach Slats (B) to unit with Wood Screws. (See Figure 2)

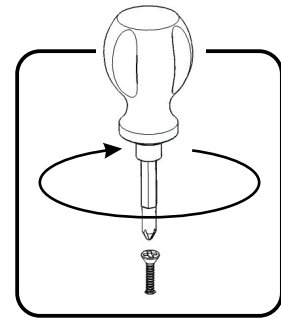

Figure 2

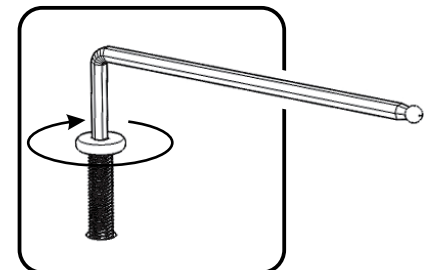
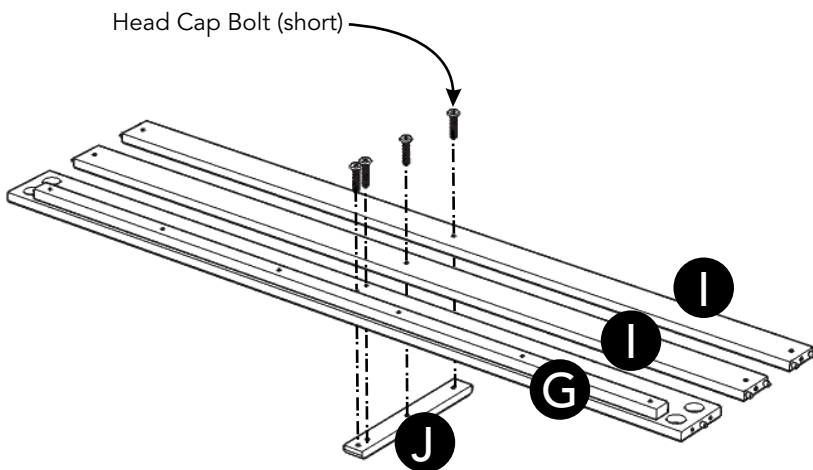
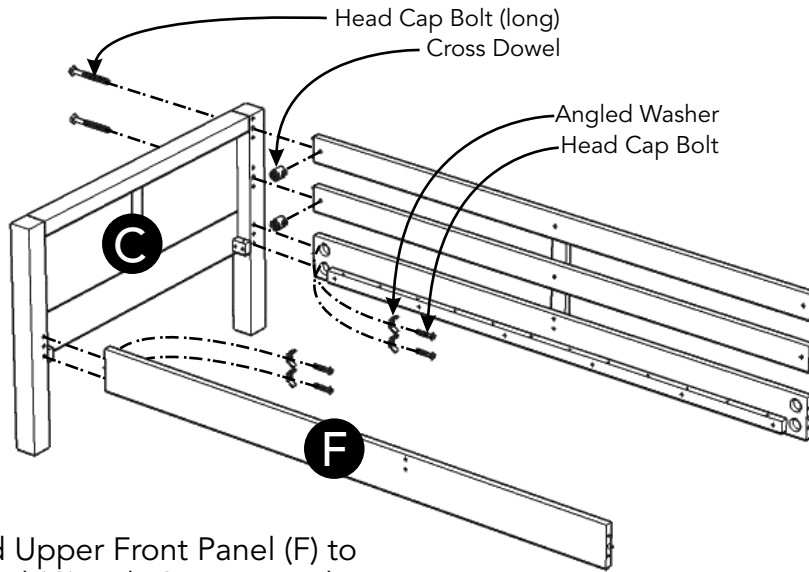

Figure 3

STEP 4

Attach Upper Back Panel (G) and Back Guardrails (I) to Support (J) with Head Cap Bolts (short), tightening bolts only halfway. (See Figure 3)

Assembly Instructions 4/6



STEP 5

Attach unit and Upper Front Panel (F) to Upper End Panel (C) with Cross Dowels, Head Cap Bolts (long), Angled Washers and Head Cap Bolts, tightening bolts only halfway. (See Figure 4)

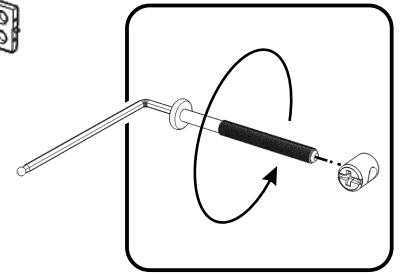
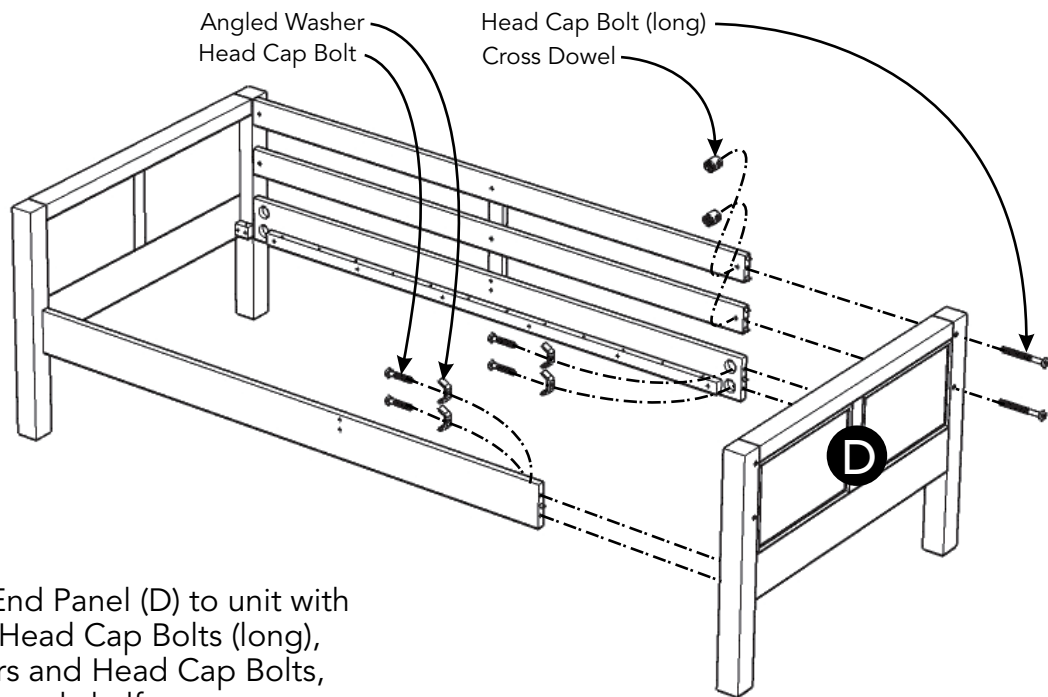

Figure 4



STEP 6

Attach Upper End Panel (D) to unit with Cross Dowels, Head Cap Bolts (long), Angled Washers and Head Cap Bolts, tightening bolts only halfway.

Tighten all bolts used in Steps 4, 5 and 6.

STEP 7

Attach Front Guardrails (H) to Support (J) with Head Cap Bolts (short), tightening bolts only halfway.

Attach Support (K) to unit with Cross Dowels and Head Cap Bolts (medium), tightening bolts only halfway.

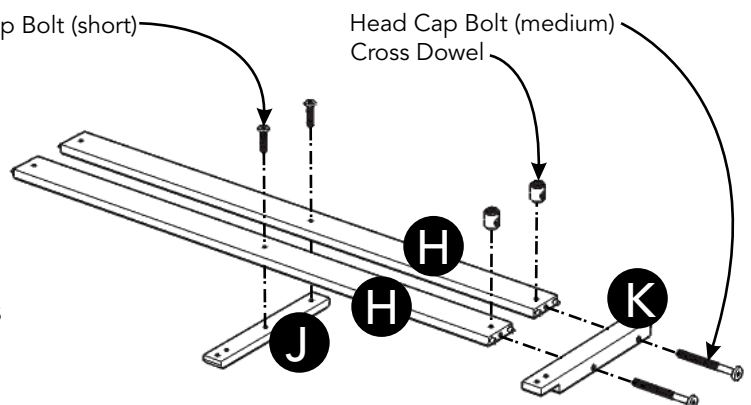

Assembly Instructions 5/6

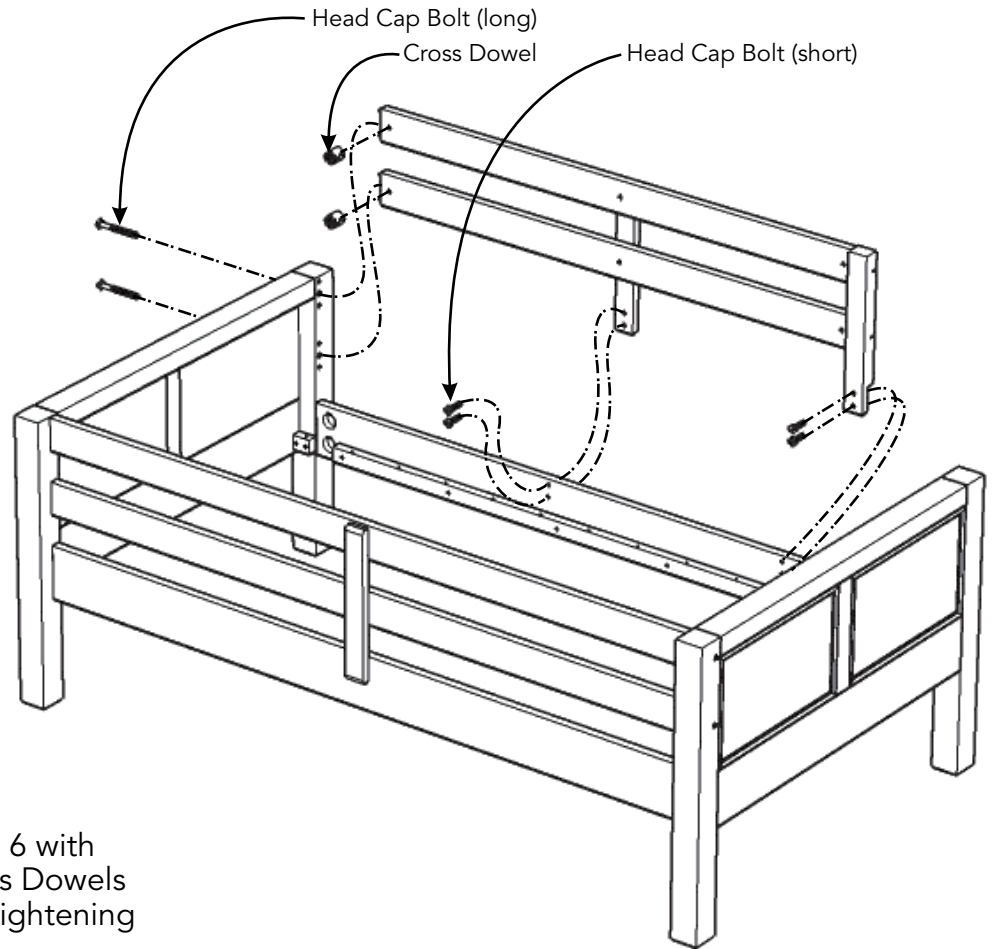

STEP 8

Attach unit to unit from Step 6 with Head Cap Bolts (short), Cross Dowels and Head Cap Bolts (long), tightening bolts only halfway.

Tighten all bolts used in Steps 7 and 8.

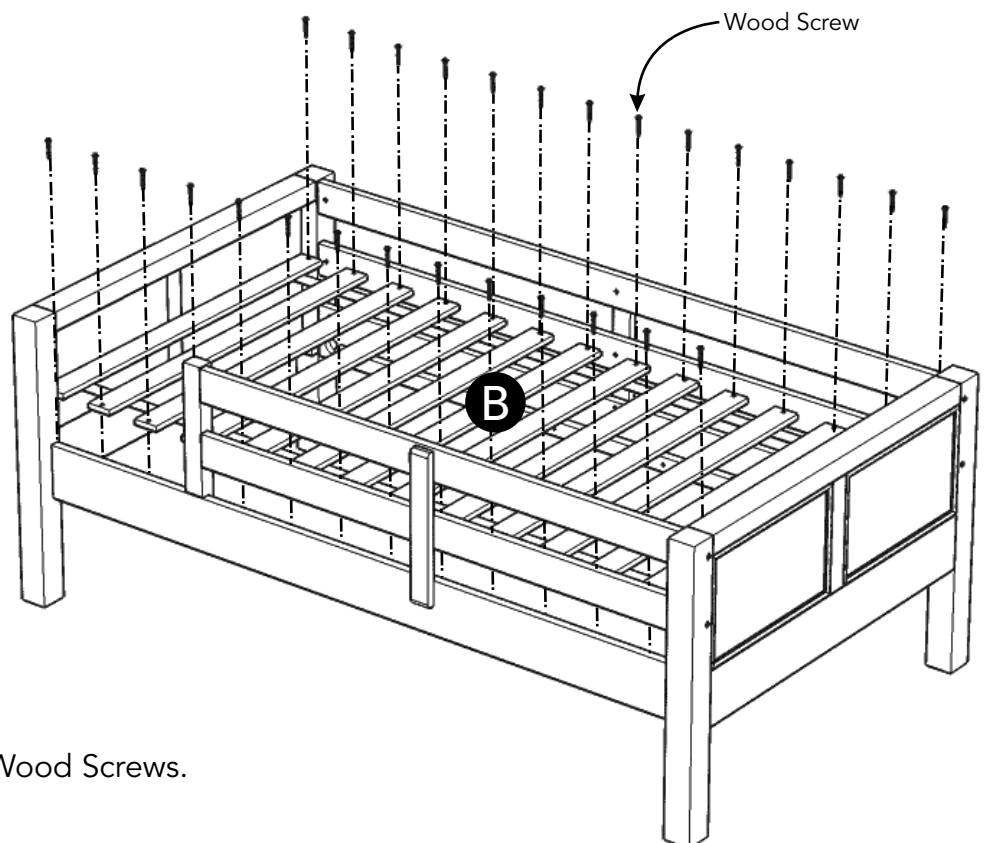

STEP 9

Attach Slats (B) to unit with Wood Screws.

Assembly Instructions 6/6

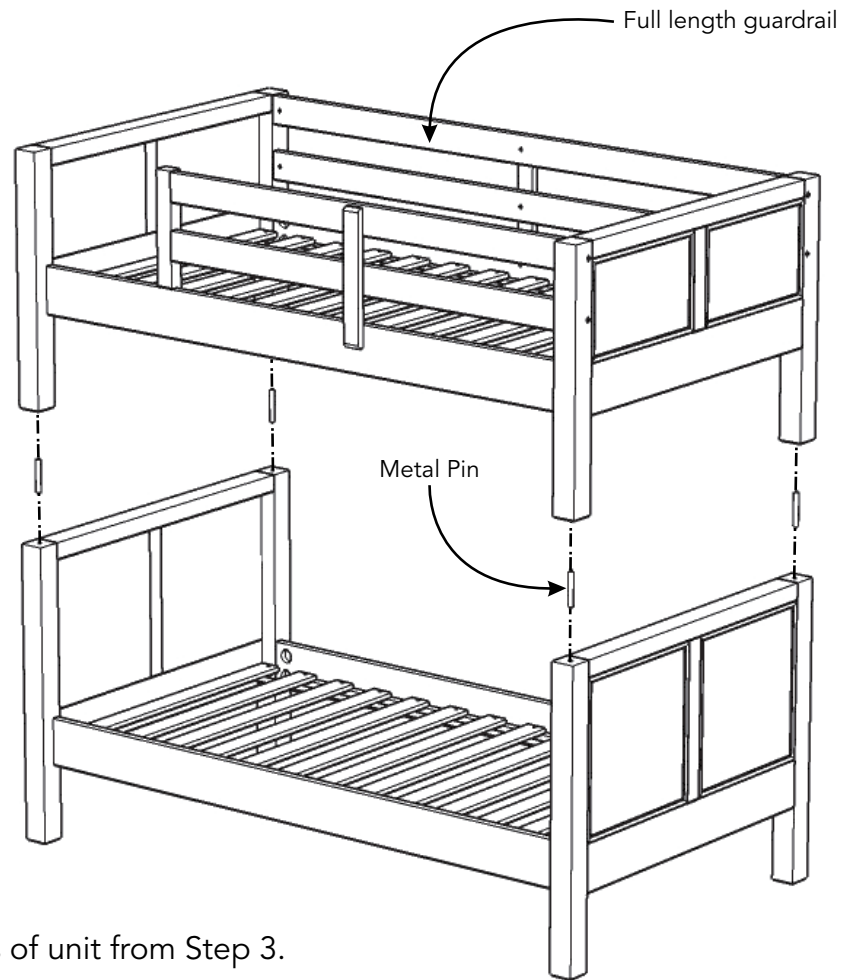

STEP 10

Insert Metal Pins into pre-drilled holes of unit from Step 3.

Attach unit from Step 9 to unit from Step 3 with Metal Pins.

Note: If back of bunk bed is placed next to a wall, the full length guardrail must be placed against the wall to prevent entrapment between bunk bed and wall.

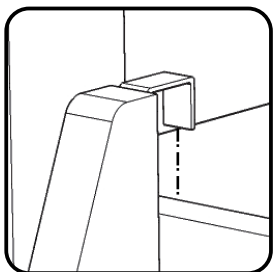

Figure 5



STEP 11

Attach Ladder (L) to unit. (See Figure 5)

IMPORTANT

Important

Use only mattress which is 74" – 75" long and 37 1/2" – 38 1/2" wide on upper bunk.

Use only mattress which is 74" – 75" long and 37 1/2" – 38 1/2" wide on lower bunk.

Use only mattress which is 10" or less thick on upper bunk.

Replacement parts, including additional guardrails may be obtained from Home Styles Customer Service at www.homestyles-furniture.com.

Safety Warnings

Follow the information on the warnings appearing on the upper bunk end structure and on the carton.

Do not remove warning label from bed.

Always use the recommended size mattresses to help prevent the likelihood of entrapment or falls.

Surface of mattress must be at least 5" (127 mm) below the upper edge of guardrails.

Do not allow children under 6 years of age to use the upper bunk.

Periodically check and ensure that the guardrail, ladder, and other components are in their proper position, free from damage, and that all connectors are tight.

Do not allow horseplay on or under the bed and prohibit jumping on the bed.

Prohibit more than one person on upper bunk.

Always use the ladder for entering and leaving the upper bunk.

Do not use substitute parts. Contact Home Styles Customer Service at www.homestyles-furniture.com for replacement parts.

Use of a night light may provide added safety precaution for a child using the upper bunk.

Always use guardrails on both long sides of the upper bunk. If the bunk bed will be placed next to a wall, the guardrail that runs the full length of the bed should be placed against the wall to prevent entrapment between the bed and wall.

The use of water or sleep flotation mattresses is prohibited.

STRANGULATION HAZARD – Never attach or hang items to any part of the bunk bed that are not designed for use with the bed; for example, but not limited to, hooks, belts, and jump ropes.

Keep these instructions for future reference.

IMPORTANTES

Importantes

Utilisez uniquement des matelas qui est de 74" – 75" de long et 37 1/2" – 38 1/2" de large sur la couchette.

Utilisez uniquement des matelas qui est de 74" – 75" de long et 37 1/2" – 38 1/2" de large sur des lits superposés.

Utilisez uniquement des matelas qui est de 10" ou moins épais sur la couchette.

Pièces de remplacement, y compris garde-corps supplémentaires peuvent être obtenus à partir de Home Styles service à la clientèle au www.homestyles-furniture.com.

Avertissements de Sécurité

Suivez les informations sur les mises en garde figurant sur la partie supérieure de la structure d'extrémité et superposés sur la boîte.

Ne pas retirer l'étiquette d'avertissement du lit.

Utilisez toujours la taille recommandée du matelas pour aider à prévenir le risque de coincement ou de chutes.

La surface du matelas doivent être d'au moins 5" (127 mm) sous le bord supérieur du garde-corps.

Ne permettez pas aux enfants de moins de 6 ans d'utiliser les lits superposés.

Vérifier régulièrement et s'assurer que les garde-corps, de bain, et d'autres composants sont dans la bonne position, exempts de dommages, et que tous les connecteurs sont bien serrés.

Ne pas laisser les bousculades sur ou sous le lit et interdire de sauter sur le lit.

Interdire plus d'une personne sur la couchette supérieure.

Toujours utiliser l'échelle pour l'entrée et à la sortie de l'angle supérieur des lits superposés.

N'utilisez pas les articles de substitution. Contact service à la clientèle de Home Styles au www.homestyles-furniture.com pour les pièces de remplacement.

Utilisation d'une lumière de nuit peut offrir une plus grande précaution de sécurité pour un enfant à l'aide de la partie supérieure de la couchette.

Utilisez toujours des garde-corps sur les deux grands côtés de l'angle supérieur des lits superposés. Si le lit est placé à côté du mur, le garde-corps qui court sur toute la longueur du lit doit être placé contre le mur pour éviter la provocation policière entre le lit et le mur.

L'utilisation de l'eau ou de sommeil matelas de portance est interdite.

DANGER D'ÉTRANGLEMENT- Ne jamais attacher ou s'accrocher articles à n'importe quelle partie du lit superposé qui ne sont pas conçus pour une utilisation avec le lit; par exemple, mais non limité à, des crochets, des ceintures, et sauter des cordes.

Conservez ces instructions pour référence future.

CARE INSTRUCTIONS

NEVER

allow liquids to remain on furniture.
Absorption causes parts to warp
and split and finishes to delaminate.

NEVER

use glass cleaners on
finished furniture. Ammonia
chemically attacks the finish.



Do not use power tools
above 8 volts to assemble.

**PREVENT
CRACKING**



Do not place
in direct sunlight.

**PREVENT
FADING**



Do not write
directly on surface.

**PREVENT
MARKING**



Do not place hot
objects on surface.

**PREVENT
FINISH DAMAGE**

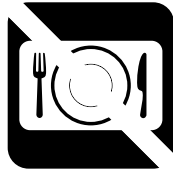

Do not use rubber
based placemats.

**PREVENT
DISCOLORING**



Do not use commercial
waxes and polishes.

**PREVENT
YELLOWING**

CLEAN

with a soft cloth moistened
in lukewarm soap and water.
Buff with a dry clean cloth.



Home Styles will provide replacements free of charge for missing or damaged hardware or parts within 30 days of purchase. Digital images of the defective parts may be required. If the product was not purchased from an authorized retail affiliate, Home Styles is under no obligation to provide replacement parts. Parts are not available for fully assembled items nor are parts available for sale. Replacements for missing or damaged hardware or parts may be requested at:

www.homestyles-furniture.com/customer-service/replacement-parts

Home Styles Customer Service: www.homestyles-furniture.com,
servicedesk@homestyles-furniture.com, 888-680-7460, 877-831-0319