

OMNIA DINING TABLE ASSEMBLY INSTRUCTIONS



PARTS PACKING CONFIGURATIONS

BOX #1

A. GLASS TOP 1 PC

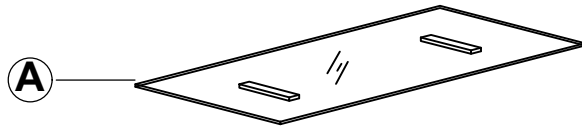

BOX #2

B. PEDESTAL BASE 2 PCS

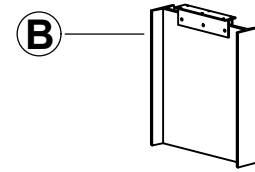

HARDWARE PACKED WITH BOX #2

No	Description	Photo	Quantity
1	ALLEN BOLT (5/16 x 5/8)		12 PCS
2	LOCK WASHER (5/16)		12 PCS
3	FLAT WASHER (5/16)		12 PCS
4	ALLEN KEY		1 PC

OMNIA DINING TABLE FULLY ASSEMBLED

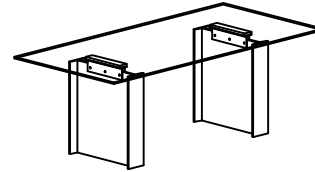
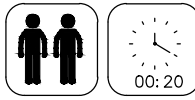

STEP 1:

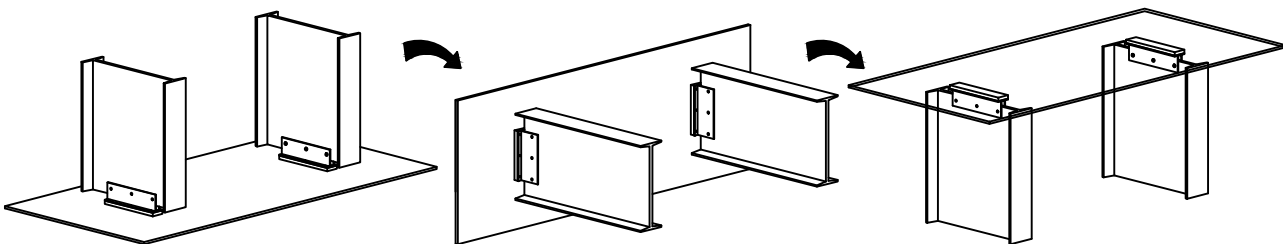
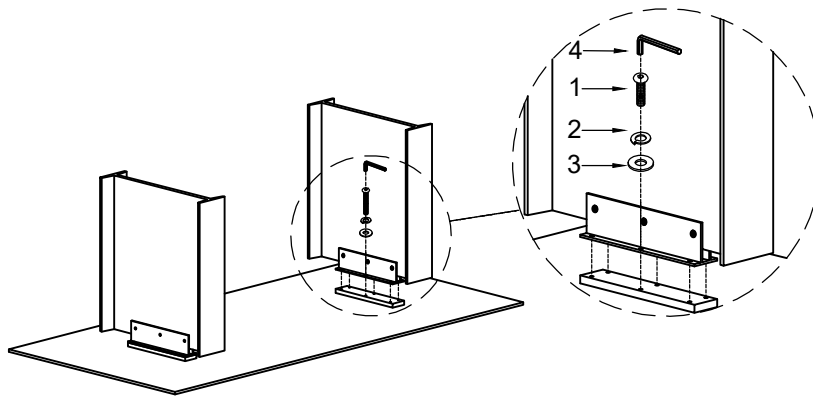

TO FLIP TABLE, FOLLOW ILLUSTRATION ABOVE. TABLE SHOULD BE TILTED TO THE SIDE, LEGS RESTING ON THE GROUND, BEFORE BEING TURNED UPRIGHT. FAILURE TO FOLLOW DIRECTIONS COULD RESULT IN DAMAGE TO THE TABLE AND/OR BODILY INJURY

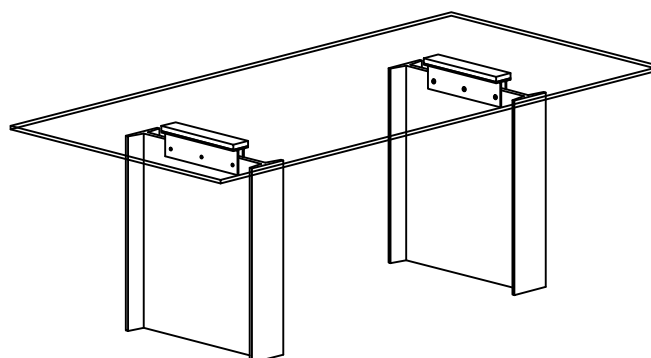

FULLY ASSEMBLED