









Thank you for purchasing this quality product. Be sure to unpack carefully looking for small parts which may have come loose during shipment.

Read all instruction and study the drawing carefully before starting the assembly process.

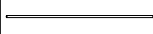
HARDWARE PACK					PARTS LIST			
NO.	DRAWING	DESCRIPTION	SIZE	Q'TY	NO.	DRAWING	DESCRIPTION	Q'TY
A		Bolt	5/16x40mm	6 PCS	1		Right Side Base	1 PC
B		Lock Washer	Ø5/16"	12 PCS	2		Left Side Base	1 PC
C		Flat Washer	Ø5/16"	12 PCS	3		Stretchers	1 PC
D		Allen Wrench	69*27.2*4mm	1 PC	4		Desk Top With Drawers	1 PC
E		Bolt	5/16x25mm	6 PCS				
F		Anti - Tip Kit		1 PC				

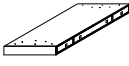

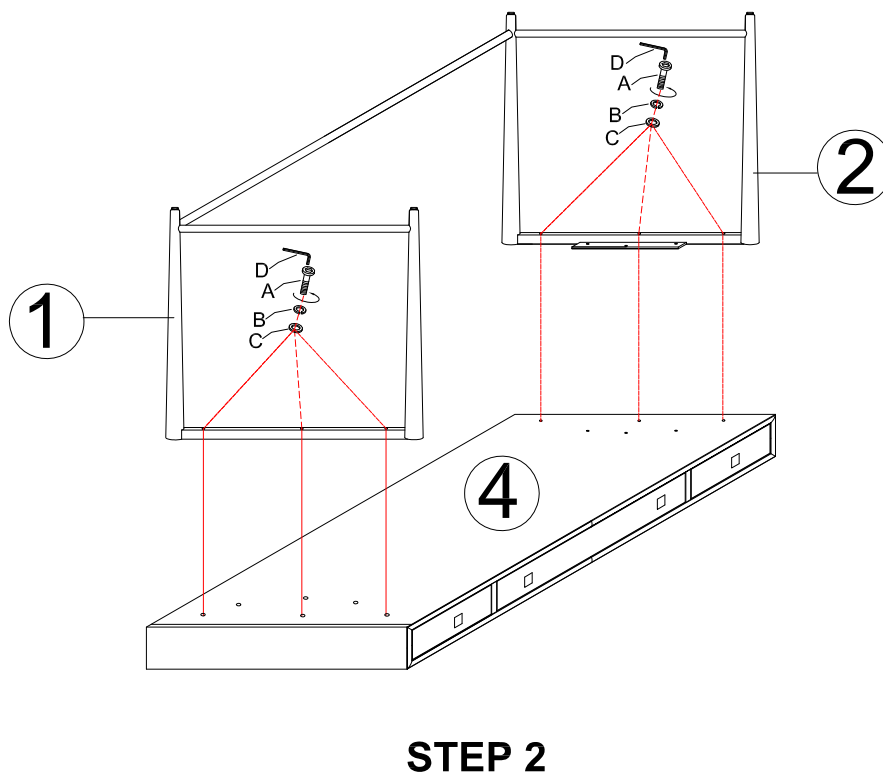
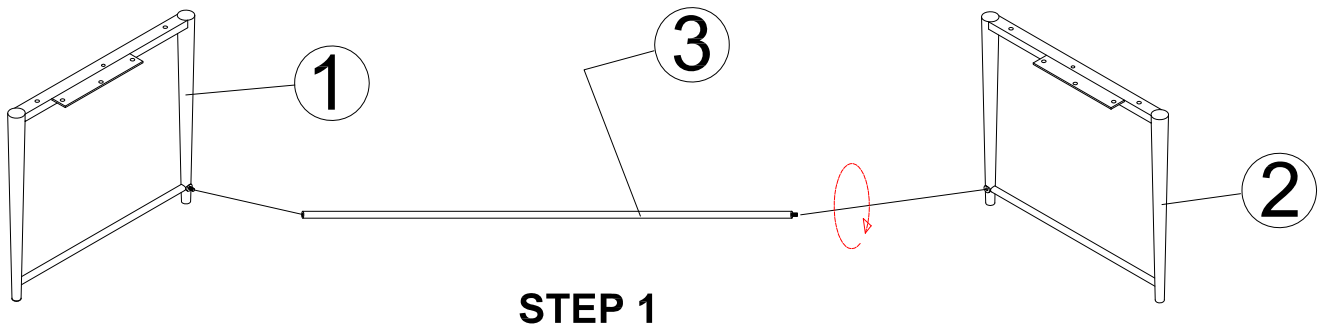
Thank you for purchasing this quality product. Be sure to unpack carefully looking for small parts which may have come loose during shipment.

Read all instruction and study the drawing carefully before starting the assembly process.

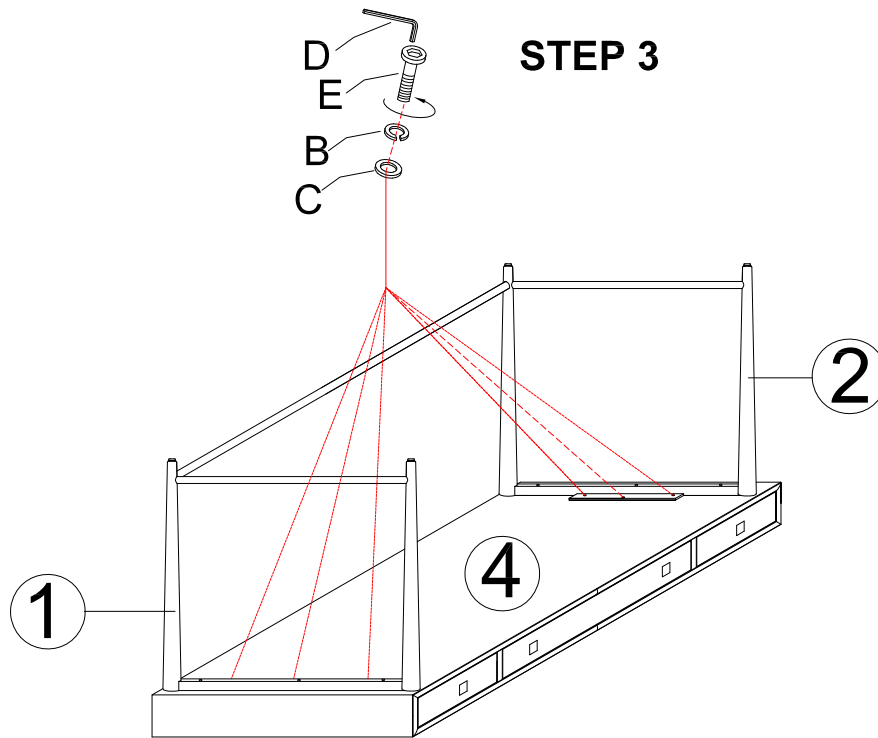

Anti-tip kit is included for use.
We recommend installing for
safety reason.

Tipping Restraint

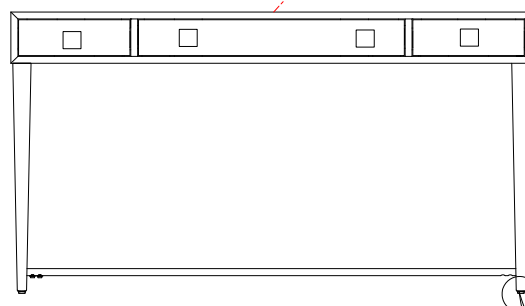
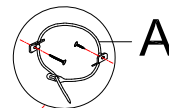

Adjust leveler if needed to level
desk on uneven floor.

