

Grey

Wyndham 2-Door 2-Drawer Vanity with Quartz 4 in. Centerset Snowdrift Top, Unassembled, 37x22

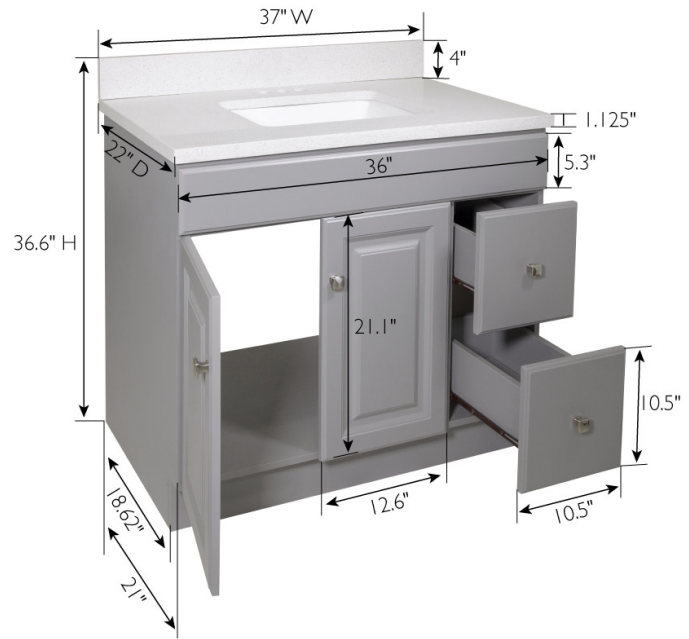

SPECIFICATIONS

MATERIAL CONSTRUCTION: Wood/Quartz
ASSEMBLY REQUIRED: Yes
ASSEMBLED DIMENSIONS: 36.63" H x 37" L x 22" D
ASSEMBLED WEIGHT: 155 lbs.
TOOLS NEEDED FOR INSTALLATION: Wrench

CONSTRUCTION TYPE: Frameless
HINGE STYLE: Concealed
DOOR STYLE: 2 MDF Slab Doors
DRAWER STYLE: 2 MDF Drawers
GLIDE STYLE: STD Easy Glide
FAKE DWR STYLE: N/A
DWR #1 DIMENSIONS: 5.12" H x 15.59" D
DWR CONSTRUCTION: Standard
SHELF STYLE: N/A
SHELF ADJUSTABILITY INCREMENTS: N/A
SHELF MAX WEIGHT CAPACITY: N/A
SHELF DIMENSIONS: N/A
SHELF THICKNESS: N/A
SHELF MATERIAL: N/A
FRAME STYLE: N/A
FACE FRAME MATERIAL: MDF
SIDES MATERIAL: Particle Board
BOTTOM MATERIAL: Particle Board

TOE KICK INSET WIDTH: 4.5"
BACK PANEL MATERIAL: N/A
BACK BRACE MATERIAL: Particle Board

FAUCET TYPE: Lav Centerset
NUMBER OF MOUNTING HOLES: 3
BOWL MATERIAL: Ceramic
BACK SPLASH INCLUDED: Yes
COLOR: Snowdrift
NUMBER OF BOWLS: 1
BOWL DIMENSIONS: 5.6" H x 11.88" W x 17.71" D
BOWL SHAPE: Rectangle
SINK THICKNESS: N/A
MOUNTING TYPE: Undermount
OVERFLOW HOLE: Yes

WARRANTY: 1-Year limited warranty
CARB COMPLIANT: CARB Phase 2
LEGAL FOR SALE IN CALIFORNIA: Yes
TSCA TITLE IV COMPLIANT: Yes



TYPE:
 JOB:
 ORDER CODE:
 APPROVALS: