

LED EDGE LIT FIXTURE INSTRUCTIONS

CAUTION

TURN OFF THE MAIN POWER AT THE CIRCUIT BREAKER BEFORE INSTALLING THE FIXTURE, IN ORDER TO PREVENT POSSIBLE SHOCK.



GENERAL

- All electrical connections must be in accordance with local and National Electrical Code (N.E.C.) standards. If you are unfamiliar with proper electrical wiring connections obtain the services of a qualified electrician.
- Remove the fixture and the mounting package from the box and make sure that no parts are missing by referencing the illustrations on the installation instructions.

MOUNTING INSTRUCTIONS

READ IMPORTANT SAFETY INFORMATION FIRST ON REVERSE SIDE OF THIS SHEET.

PARTS INCLUDED:	QTY
1. Mounting Bracket	1
2. Lamp unit	1
3. #8-32 x 1/2 screws	2
4. Toggle Bolts	4
5. Wire nuts	3

1. To attach the **Mounting Bracket** to the Junction box in the Ceiling, follow these steps:

- a) Twist and unlock the mounting bracket from the round LED flat panel fixture to remove.

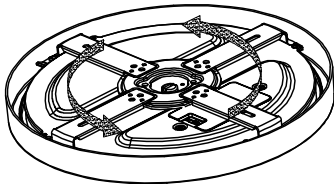

- i) Use a pencil to mark the four hole positions for the toggle bolts going in the ceiling.

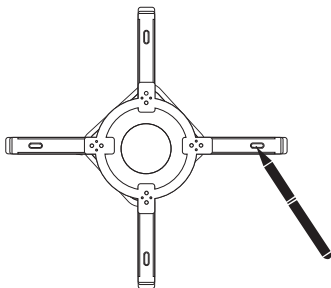

- b) Identify all three wires (Black-line- voltage, White-neutral, Green- ground) from junction box and make them accessible for easy connections.

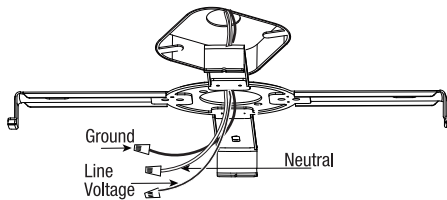

- ii) Remove the bracket and use a drill with 3/8" drill bit to make holes on the marks made for the toggle bolts.

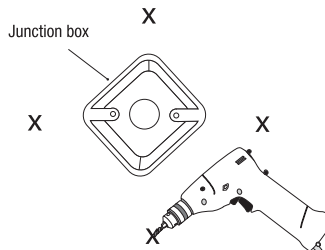

- c) Secure the bracket to the junction box using the Junction box screws with toggle bolts provided. If securing the bracket with toggle bolts is also desired, follow steps i to iii. Otherwise, proceed to step 2.

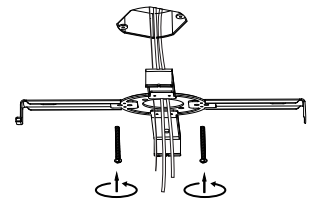

- iii) Install the toggle bolts into place on the mounting bracket. Raise and feed the junction wires through the mounting bracket center hole. Secure mounting bracket to junction box by inserting toggle bolts into the ceiling holes and tighten screws.

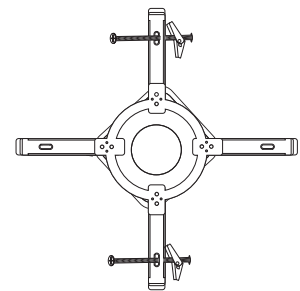

2. Connecting the electrical wires and installing fixture into place, follow these steps:

- a) Hook up the support wire to hold fixture while you make the electrical connections. (See Fig.1)

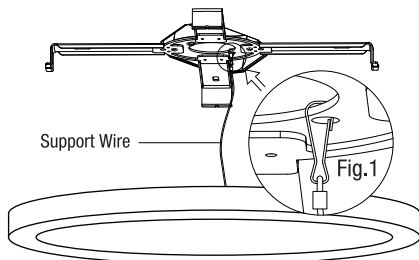

- b) Connect the 3 wires coming from the fixture to the wires coming out the junction box. (See Fig.2) (Black-line voltage, White-neutral, Green- ground).

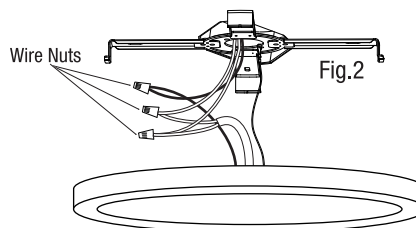

SAVE THESE INSTRUCTIONS.

LED EDGE LIT FIXTURE INSTRUCTIONS

3. Align the dots behind the fixture to the arms on the mounting bracket, as shown. Raise the fixture up into the mounting bracket, making sure you push/feed the electrical wires through the mounting bracket center hole and up to the junction box.

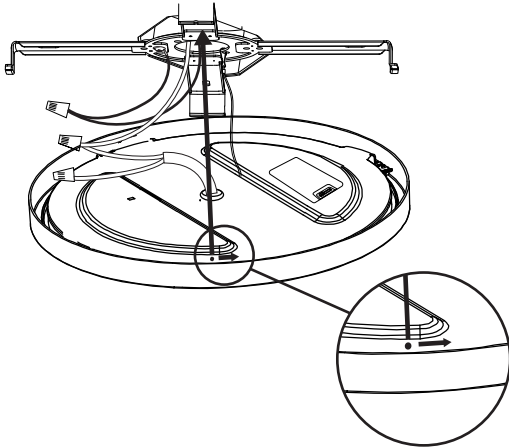

4. Twist and lock fixture into the mounting bracket in the Lock direction of the arrows next to the dots.

WARNING!! IF NOT LOCKED IN PLACE THE FIXTURES MAY FALL AND CAUSE SERIOUS INJURY!!

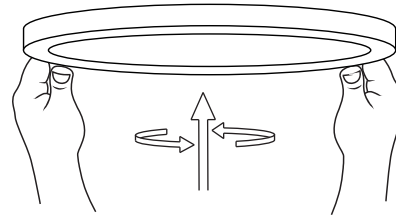

IMPORTANT SAFETY INFORMATION

1. **WARNING: RISK OF SHOCK** House electric current can cause painful shock or serious injury unless handled properly. For your safety, always remember to:
 - A. Turn off the power Supply at the fuse or circuit breaker box before you install the fixture.
 - B. Ground the fixture to avoid potential electric shocks and to ensure reliable starting.
 - C. Double-check all connections to be sure they are tight and correct.
 - D. Wear rubber soled shoes and work on a sturdy wooden ladder.
2. This fixture is designed for use in a circuit protected by a fuse or circuit breaker. It is also designed to be installed in accordance with local electrical codes. If you are unsure about your wiring, consult a qualified electrician or local electrical inspector, and check your local electrical code.
3. **WARNING: RISK OF CUTS** Some metal parts in the fixture may have sharp edges. To prevent cuts and scrapes, wear gloves when handling the parts.
4. Account for small parts and destroy packing material, as these may be hazardous to children.

CAUTION

WARNING: Risk of fire. Use only on 120 volt 60Hz circuits. Suitable for damp locations. Before installing your lighting fixture, thoroughly review enclosed installation manual. If you do not have sufficient electrical wiring experience, please refer to a do-it-yourself wiring handbook or have your fixture installed by a qualified licensed electrician. All electrical connections must be in accordance with Local and National Electrical Code (NEC) Standards. Reliable operating temperature is 0°F –120°F. If flickering occurs in low level dimming, increase light level. Compatible with most dimmers including Leviton 6681-IW, Lutron S-600P and Lutron DVCL-153. Dimmable to 10% with most dimmers. For more information including dimmer compatibility visit www.feit.com or call our toll free number 1-866-326-BULB.

This device complies with part 15 of the FCC Rules. Operation is subject to the following two conditions:
 (1) This device may not cause harmful interference, and
 (2) this device must accept any interference received, including interference that may cause undesired operation.
 Note: This equipment has been tested and found to comply with the limits for a Class B digital device, pursuant to part 15 of the FCC Rules. These limits are designed to provide reasonable protection against harmful interference in a residential installation. This equipment generates, uses and can radiate radio frequency energy and, if not installed and used in accordance with the instructions, may cause

harmful interference to radio communications. However, there is no guarantee that interference will not occur in a particular installation. If this equipment does cause harmful interference to radio or television reception, which can be determined by turning the equipment off and on, the user is encouraged to try to correct the interference by one or more of the following measures: Reorient or relocate the receiving antenna. Increase the separation between the equipment and receiver. Connect the equipment into an outlet on a circuit different from that to which the receiver is connected. Consult the dealer or an experienced radio/TV technician for help.

LIMITED WARRANTY

This product is warranted to be free from defects in workmanship and materials for up to 5 years from date of purchase. If it fails to do so, please contact Feit Electric at info@feit.com or call 1-866 326-BULB (2852) for instructions on replacement. Do not return the product to the store.

For comments please write to:
 FEIT ELECTRIC
 Customer Service Department
 4901 Gregg Road, Pico Rivera, CA 90660

SAVE THESE INSTRUCTIONS.

COLOR CHANGING INSTRUCTIONS

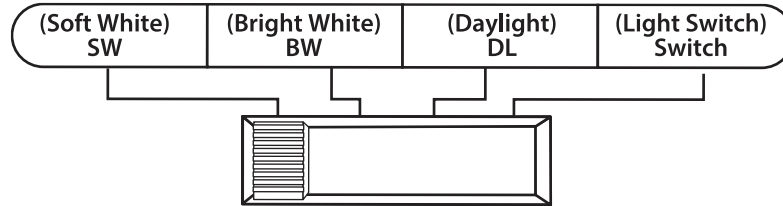

1. You can lock in one color temperature, change among multiple color temperatures, dim from 10%-100%, memorize the last color temperature, and reset automatically.
2. Soft White - Bright White - Daylight - Light Switch Marks on the lamp: SW-BW-DL-Switch
3. When the slide switch is set to SW (Soft White), the color temperature is set to 3000K.
4. When the slide switch is set to BW (Bright White), the color temperature is set to 4000K.
5. When the slide switch is set to DL (Daylight), the color temperature is set to 5000K.
6. When the slide switch is set to SWITCH, the color temperature can be changed from SW-BW-DL with your existing light switch.
7. To change color temperatures using your existing light switch:
 - A. Set the slide switch on the back of the fixture to "SWITCH"
 - B. Toggle your light switch ON and OFF within 0.5-3 seconds to cycle through the 3 different color temperatures.
 - C. If the fixture is left OFF over 10 seconds then turned ON, the fixture will remember the last color temperature selected and will display that color when turned on again.
8. Reset function is used when using multiple Color Selectable lighting products operating from the same light switch. In the event multiple fixtures are not displaying the same color at the same time, fixtures must be RESET using your existing light switch. Toggle the wall switch ON and OFF seven times leaving it in the ON position within 1 second and leaving it in OFF position within 1 second. (ex: Fixture in ON position, toggle the wall switch OFF leaving it OFF within 1 second then ON leaving it ON within 1 second, Repeating for a total of seven times.)