

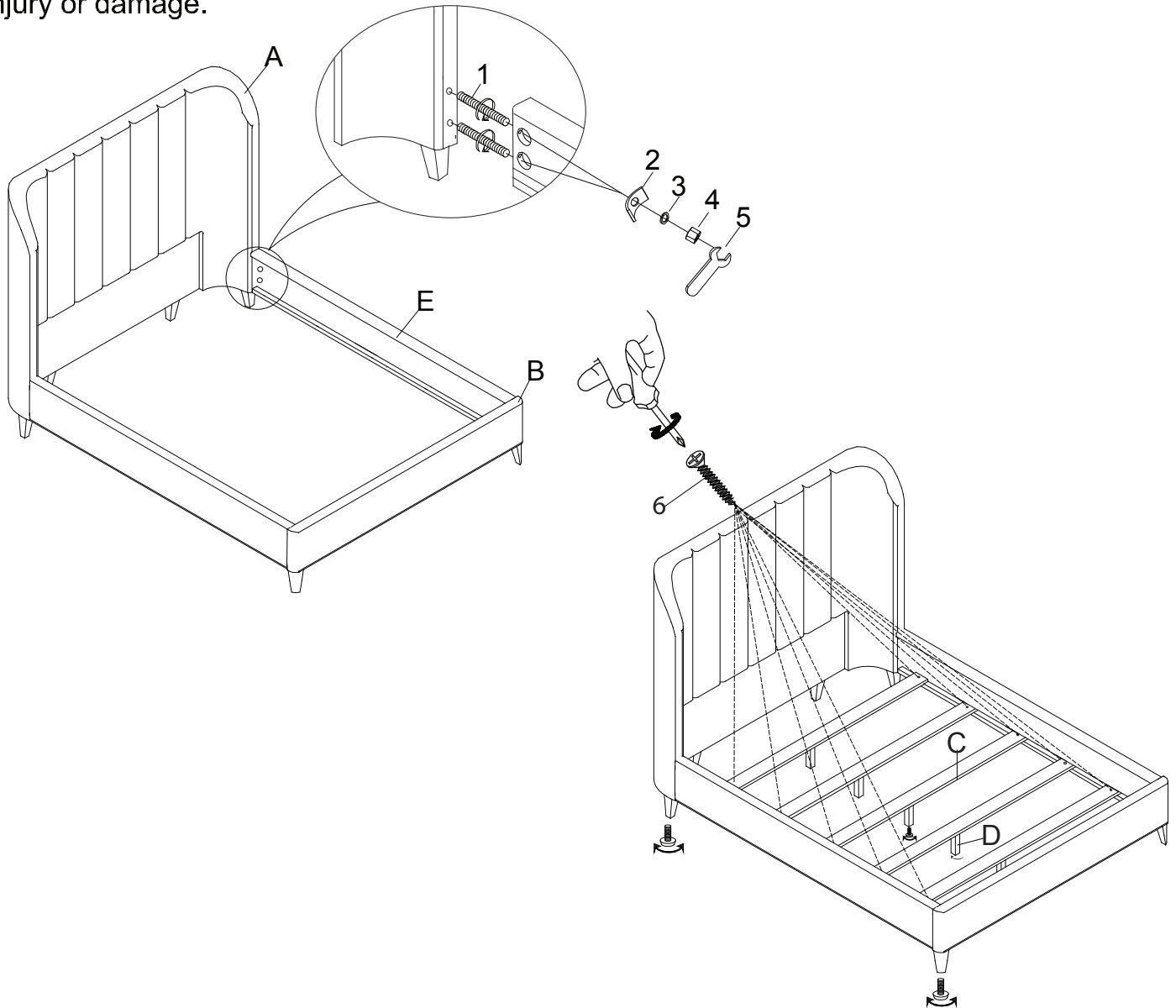











Thank you for purchasing this quality product from A.R.T. Furniture. Be sure to check all packing material for parts which may have come loose inside the carton during shipment. Identify and count all parts and compare with the parts list below.

**Note:** Some furniture is heavy, it is recommended that two people assembly this item to avoid injury or damage.



No.	Hardware List		Qt.
1		$\frac{5}{16}$ " X $3 \frac{3}{8}$ " Threaded Rod	8
2		$\frac{5}{16}$ " Half moon washer	8
3		$\frac{5}{16}$ " Lock Washer	8
4		$\frac{5}{16}$ " Nut	8
5		12mm Wrench	1
6		#8 X 28mm Wood Screw	10

No.	Parts List		Qt.
A		Headboard	1
B		Footboard	1
C		Slats	5
D		Support legs	5
E		Side Rails	2