



**Extended Warranty
Sign Up**

E-1

Welcome home!

4042664

**TEAMSON HOME
Outdoor 70" Solar Kinetic
Windmill Spinner Coppe**

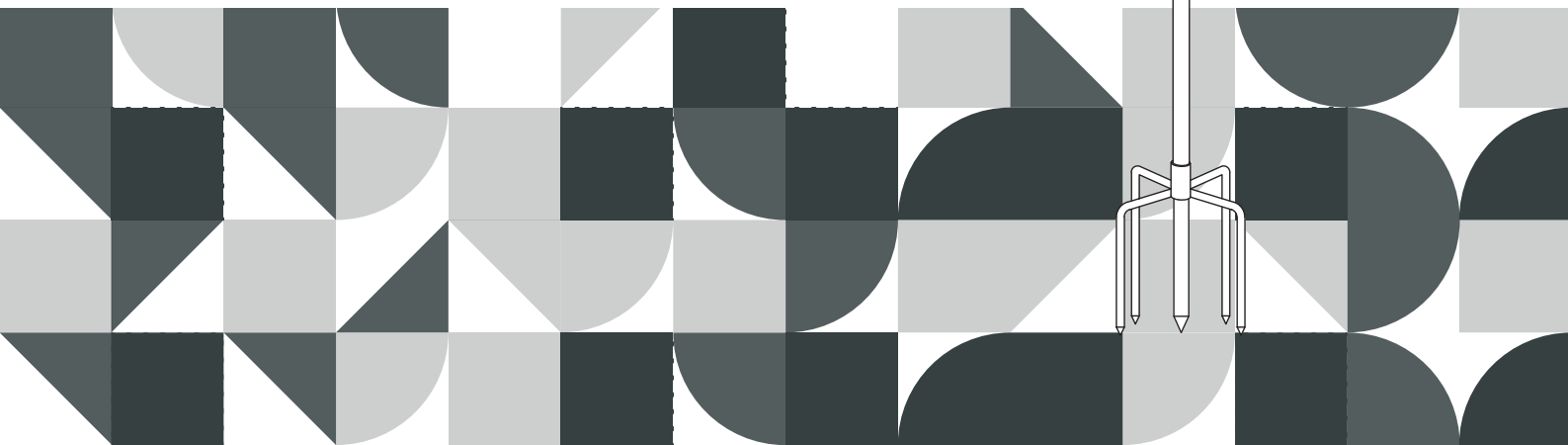
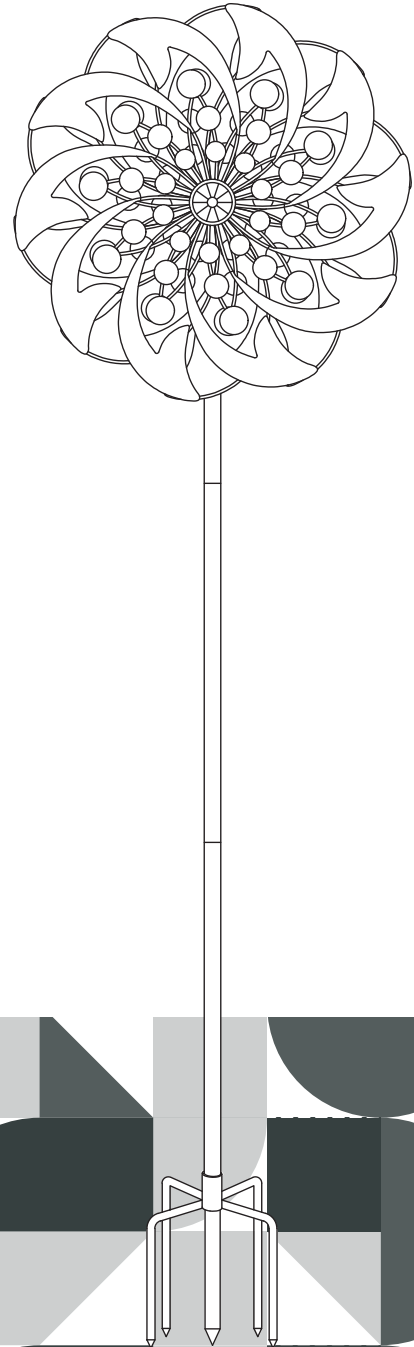

Warranty

All components are warranted by the manufacturer for a period of 30 days after the date of purchase by the original owner against defects in materials & workmanship under normal use. If it is appropriate to replace your product due to specific defects, the manufacturer will replace the purchase with the same product or a comparable product.

For specific instructions on how to obtain warranty service for your product, please contact Customer Support using the contact information provided.

Global Customer Support

USA / CA — ✉ support@teamson.com
+1(770) 246-4898
Mon - Fri 9 AM - 4 PM EST



EU / UK — ✉ support@teamson.co.uk
+44(0)1952-916-050
Mon - Thur 9 AM - 5 PM GMT
Fri 9 AM - 4 PM GMT



ASIA — 深圳办公室：
✉ sales_ec@teamson.com
+86(0755)8885-3558.分机号108
Mon - Sat 9 AM - 5 PM GMT+8

台北辦公室：
✉ support@teamson.com.tw
+886(2)2556-6268
Mon - Fri 9 AM - 5 PM GMT+8



AU — ✉ support@teamson.com.au

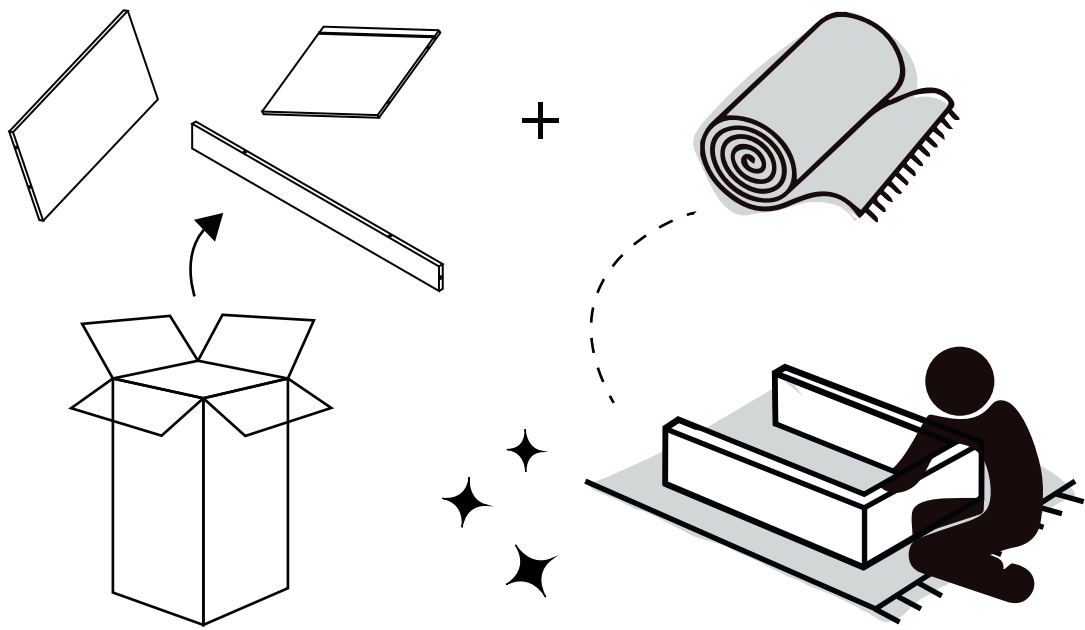

Any questions? Please contact our customer support team by email or phone. We are always ready to assist you! Please have the product item number ready, (located on the first page of this instruction manual) and your order number available.

Warranty

LIMITATIONS

All components are warranted by the manufacturer for a period of 30 days after the date of purchase by the original owner against defects in materials & workmanship under normal use. If it is appropriate to replace your product due to specific defects, the manufacturer will replace the purchase with the same product or a comparable product.

GENERAL TERMS & CONDITIONS

1. Proof of purchase is required to request a claim under this warranty.
2. This warranty applies only to manufacturer errors & defects. The warranty applies to the following:
 - a. Breaks and cracks in the product that originated with the manufacturer.
 - b. Missing pieces.
 - c. Stains that occurred during the manufacturing process.
3. This warranty does not apply to the following:
 - a. Damage due to improper loading, handling, or transportation.
 - b. Any costs associated with the installation and removal of products or parts subject to this warranty.
 - c. Acts of God.
 - d. Products which have been subject to negligence, abuse, accident, misapplication, tampering, alteration, or modification.
 - e. Products which have been subject to improper installation, operation, maintenance, repair, or storage.
 - f. Products which have been subject to defects that occur when this product is used incorrectly and/or outside of normal application purposes.
 - g. Products which have had, including but not limited to, operational failures caused by corrosion, rust, or other foreign materials in the system, or operation at pressures in excess of recommended maximums.
 - h. All other possible defects not mentioned here that would not have occurred during manufacturing or during correct, routine use of the item.

INSTRUCTIONS

For specific instructions on how to obtain warranty service for your product, please contact Customer Support using the contact information provided. In most circumstances, you will need to return your product either in its original packaging or in equally protective packaging to the address specified by Customer Support.

Before delivering your product for warranty service, it is your responsibility to remove all personal items and belongings you may have stored with your product. Teamson is not responsible for the possible loss, destruction, or damage of any personal items or belongings that have been sent with the product.

DISCLAIMER

Any oral statements made about the product by the seller, the manufacturer, the representatives, or any other parties do not constitute warranties, should not be relied upon by the user, and are not part of the contract for sale. The sellers and manufacturers only obligation, and buyers only remedy shall be for the manufacturer to either replace and /or repair at the manufacturers sole discretion, the product as described above. Neither seller nor the manufacturer shall be liable for any injury, loss or damages for lost profits, lost sales, injury to person or property, or any other incidental or consequential loss arising from any cause whatsoever, no matter whether based upon warranty, contract, negligence or other misuse, and the buyer and user agree that no other remedy shall be available to them. Before using, the buyer and user shall determine the suitability of the product for intended use, and assume all risk and liability whatsoever in connection therewith. The warranty and remedy described in this limited warranty is an exclusive warranty and remedy in lieu of any other warranty or remedy expressed or implied. All other warranties and remedies are hereby expressly excluded, including but not limited to any implied warranty of merchantability of fitness for any particular purpose.

OTHER LEGAL RIGHTS

This warranty gives the buyer and user specific legal rights, and buyer and user may also have other rights which vary from state to state. Some states do not allow exclusions or limitation of incidental or consequential damages, so the above limitations or exclusions may not apply to you.

THANK YOU

We appreciate the trust and confidence you have placed in Teamson through the purchase of this product. We strive to continually create quality products designed to enhance your home and life. Visit us online to see our full line of products available for your home décor, toy, and pet needs. Thank you for choosing Teamson!



Scan for assembly instructions.



FR

Pensez à donner ou recycler.



Association



Magasin



Déchèterie

<https://quefairedemesdechets.fr>

Introduction to Solar Light Feature

Sunlight absorbed by the solar panel feature on this windmill is converted to a stored power source that can illuminate the solar light at night. The duration of illumination will depend on the amount of sunlight and the charge of the battery.

POSITION

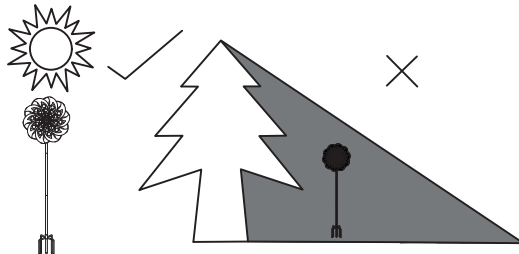

Position the solar panel to receive the maximum amount of sunlight.

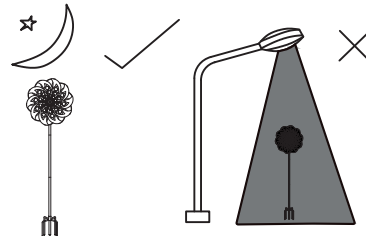

Do not position under bright light as this will prevent the light switching on at night.

FIRST USE

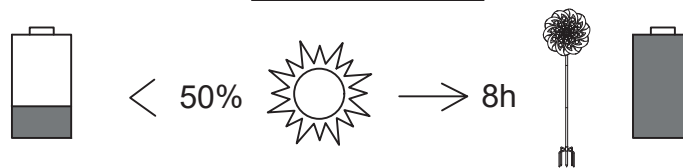

NOTE: The diagrams shown are for illustrative purposes only and are not to scale.

FOR INITIAL CHARGE: Turn the switch to “ON” located on the bottom of the solar feature and leave in the “on” position for 2 sunny days to ensure a full charge.

INSTRUCTIONS: Turn the switch to “ON” and place the product in direct sunlight. A sensor located on the solar panel will trigger the solar power and illuminate the light at night.



Scan for assembly instructions.

Exploded Drawing

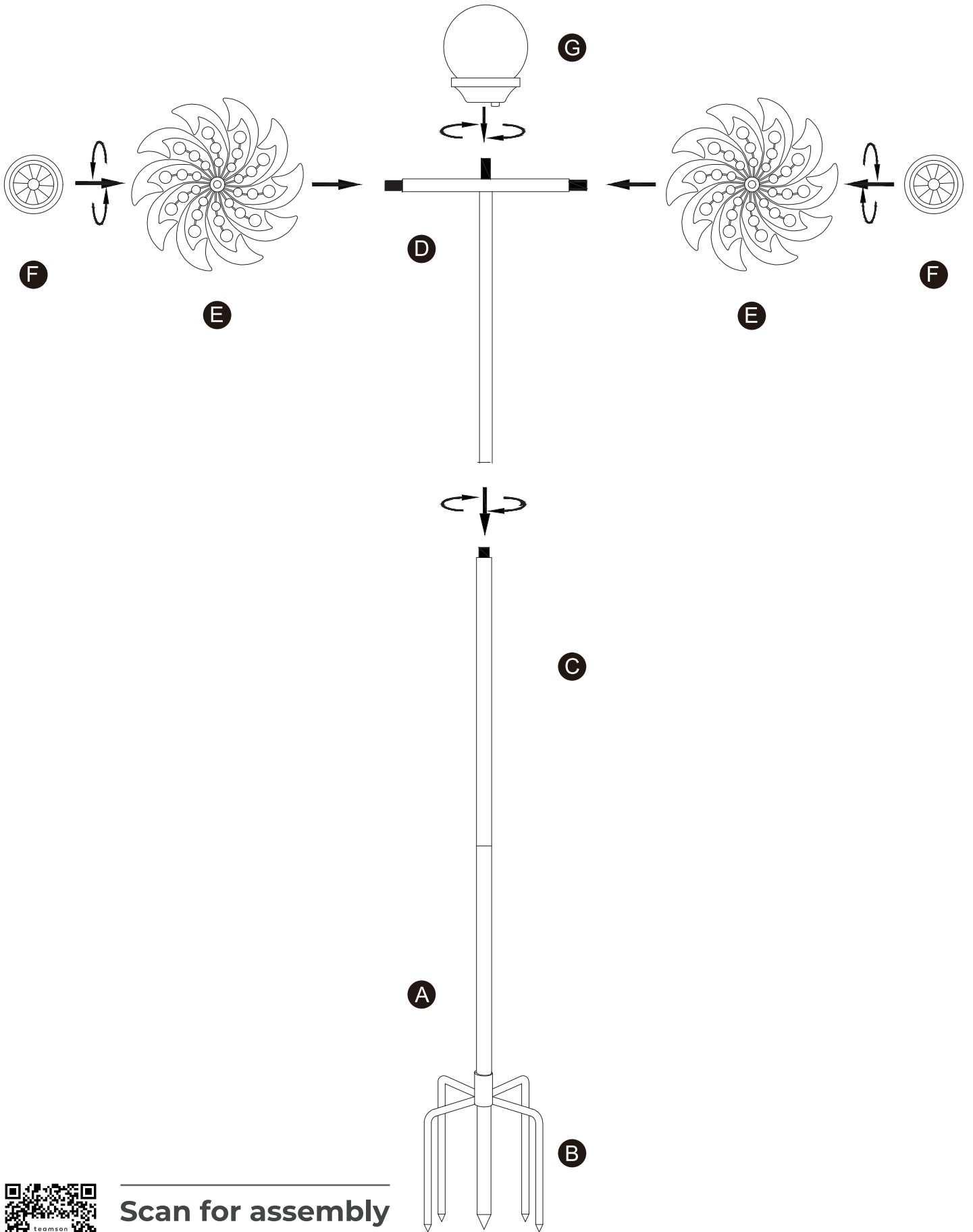

Scan for assembly instructions.

Product Parts

A

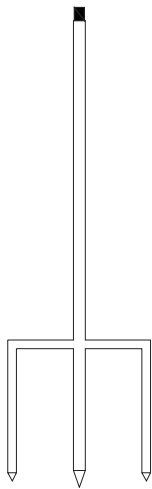

1 PC

B

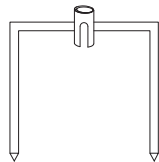

1 PC

C



1 PC

D

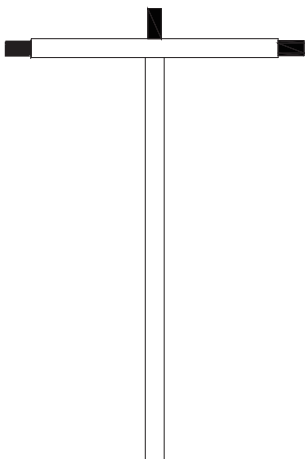

1 PC

E

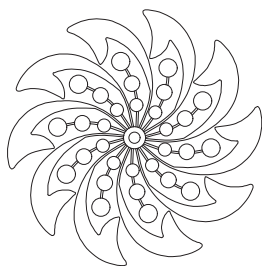

2 PC

F



2 PC

G

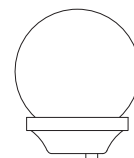

1 PC



Scan for assembly instructions.

! Care Instructions

Dust surface with a dry soft cloth.

Do not use window cleaners or cleaning abrasives as they will scratch the surface and could damage the protective coating.

! WARNING

Small parts and sharp edges may be present prior to assembly.

Step-by-Step Illustrations

Step 1

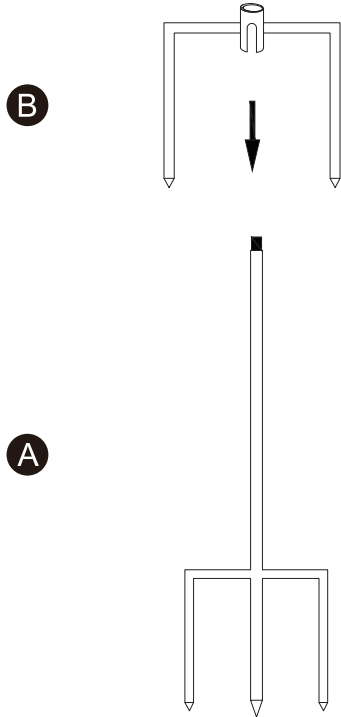

Step 2

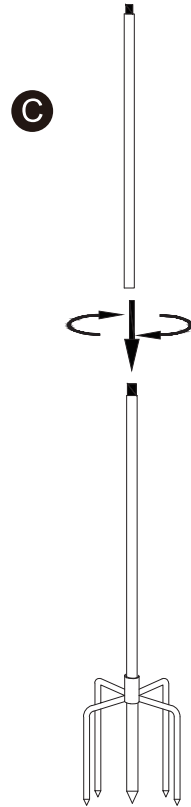

Step 3

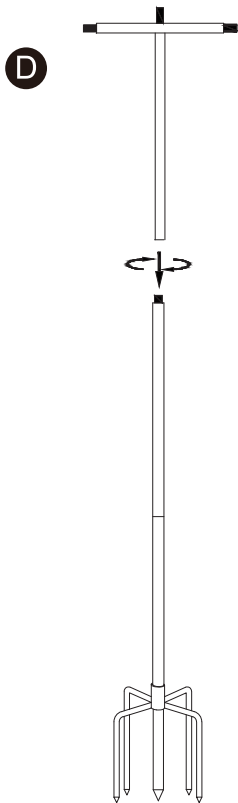

Step 4

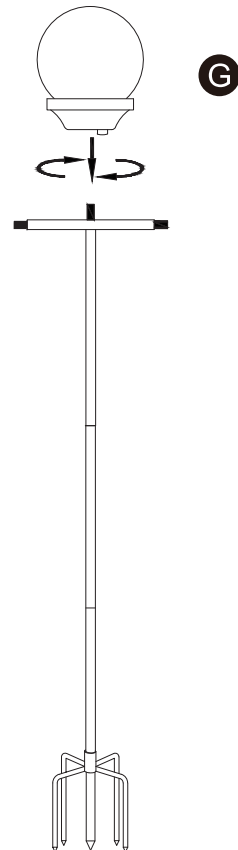

Scan for assembly instructions.

Step-by-Step Illustrations

Step 5

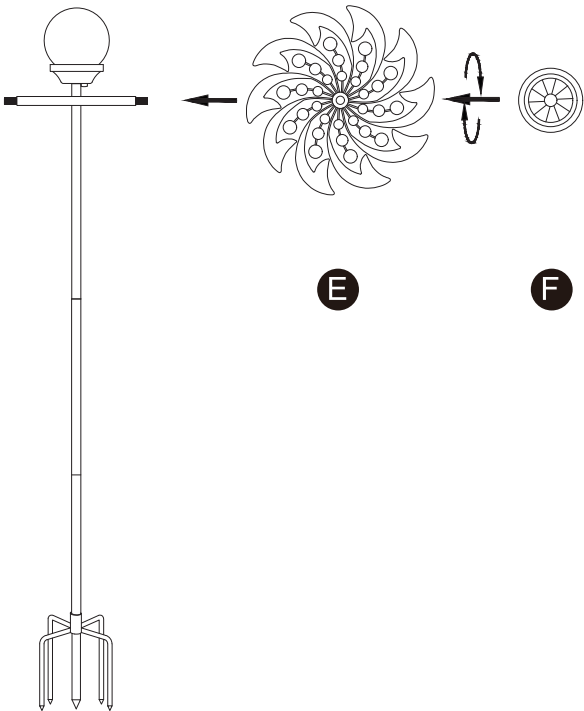

Step 7

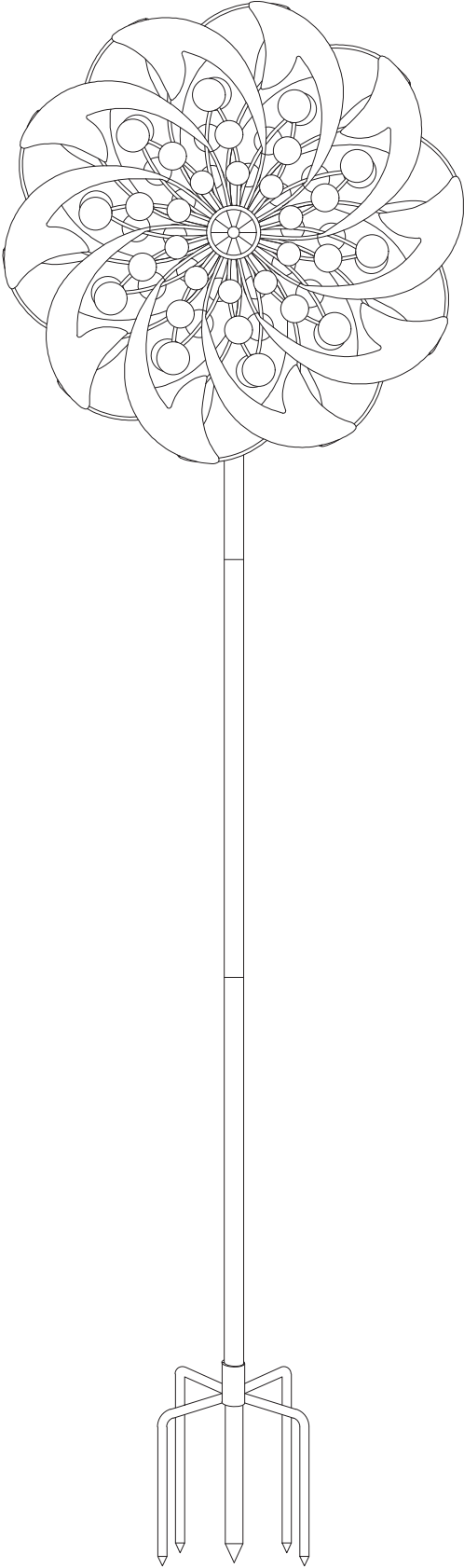

Step 6

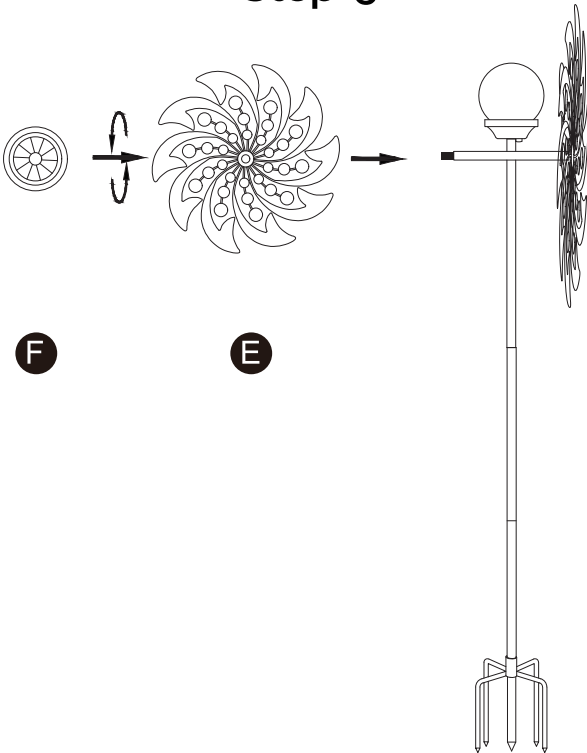

Scan for assembly instructions.