

SIDES	BOTTOM
2 pcs #1/4-28×3/8 Screws Installed	
Material:Steel-Welding tuble, zinc plated	

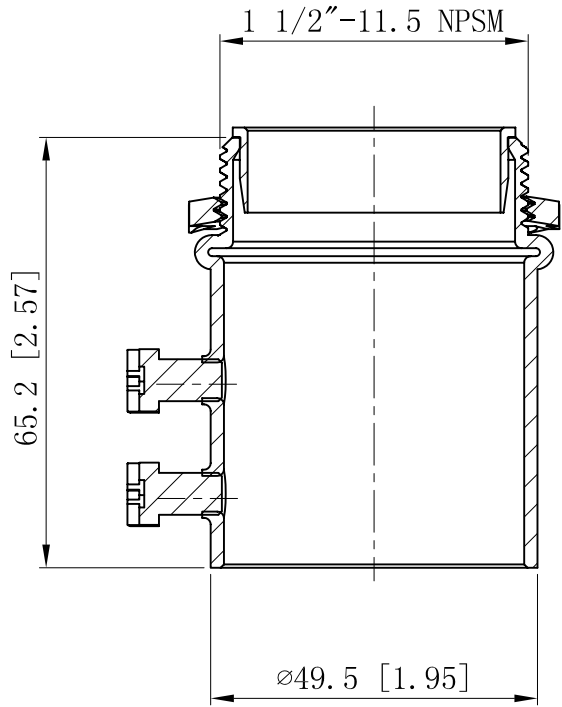

CUTAWAY VIEW A-A

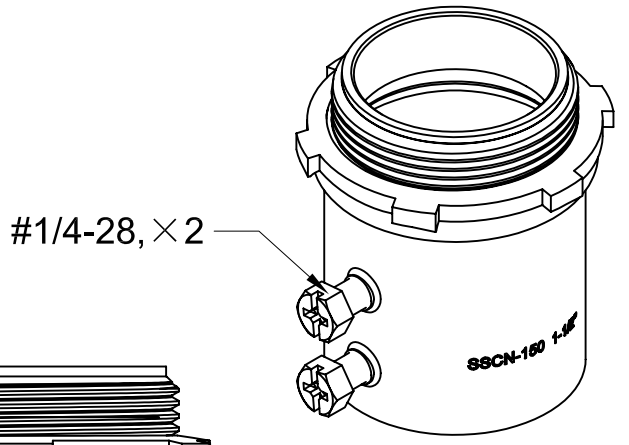
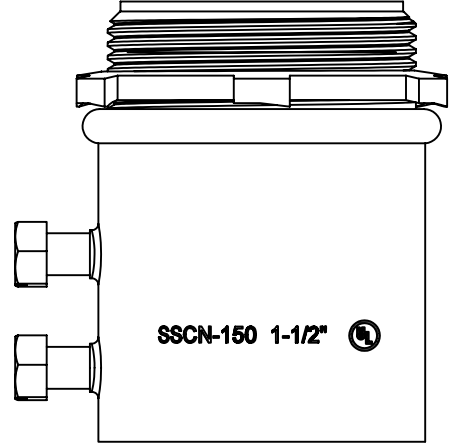
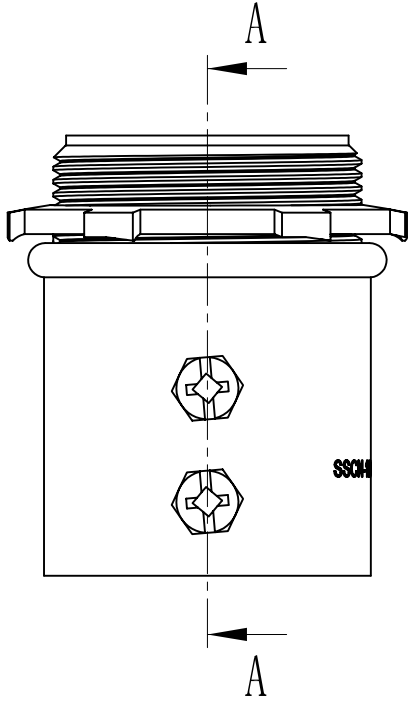

DESCRIPTION
TRADE REFERENCE TERMS

STANDARD PACKING
25 PCS

This data sheet is for reference only .GARVIN INDUSTRIES reserves the right to make changes to the design without prior notice.

<b>GARVIN INDUSTRIES</b>		
TITLE STEEL EMT SET SCREW CONNECTORS		
SIZE A4	DWG NO. SSCN-150I	REV A
DATA SHEET		