

STUPENDOUS STUNTS LIGHT-UP REMOTE CONTROL CAR STZ-7101

Review all information before using this product. Save this manual for future reference.

 Save the packing slip.

 **WARNING**
CHOKING HAZARD —
Small parts.

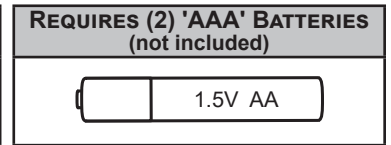
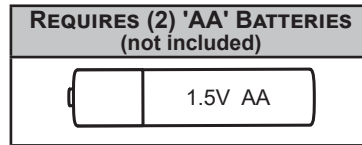
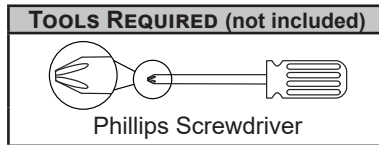

TIP: Use quality batteries for maximum operating time; low-quality batteries will need to be replaced more frequently. Do not mix new and old batteries. Do not mix alkaline, standard, or rechargeable batteries.

BATTERY INSTALLATION

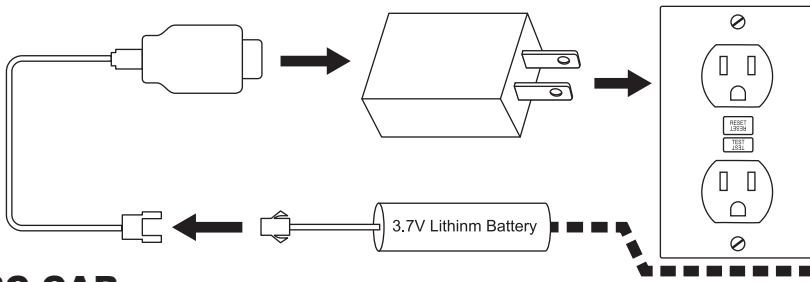

RC CAR

Charge the included lithium battery; approximate charge time: 2-3 hours.

Disconnect the battery from the charging cable.

Remove the battery cover from the bottom of the RC car and install the battery.

Replace the battery cover.

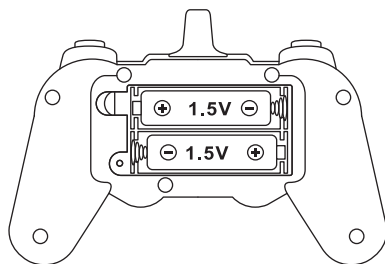
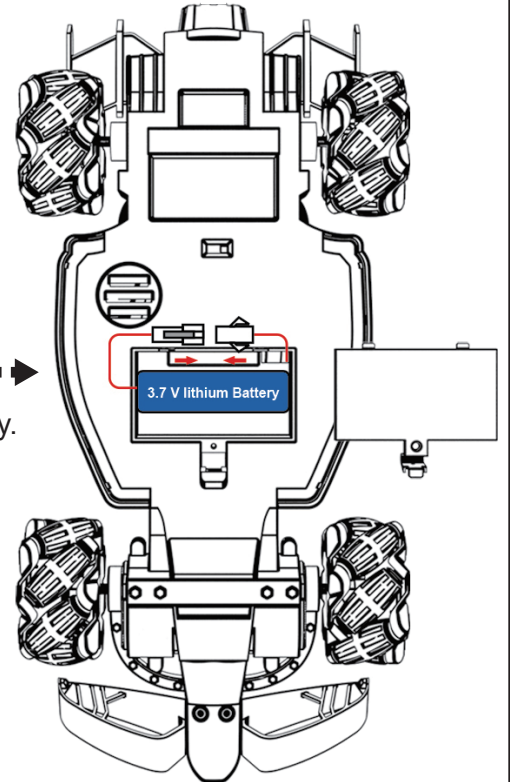

HANDHELD REMOTE

Remove the battery cover.

Paying close attention to the positive and negative terminals, insert two 'AA' batteries (not included).

Replace the battery cover.

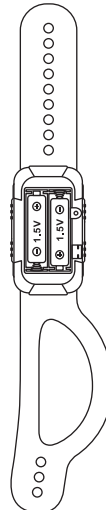

HAND GESTURE REMOTE

Remove the battery cover.

Paying close attention to the positive and negative terminals, insert two 'AAA' batteries (not included).

Replace the battery housing cover.

OPERATION



RISK OF ELECTRIC SHOCK! NO USER-SERVICEABLE PARTS INSIDE!

ALWAYS turn the remote and RC vehicle **OFF** before changing batteries. Failure to do so could result in electric shock.

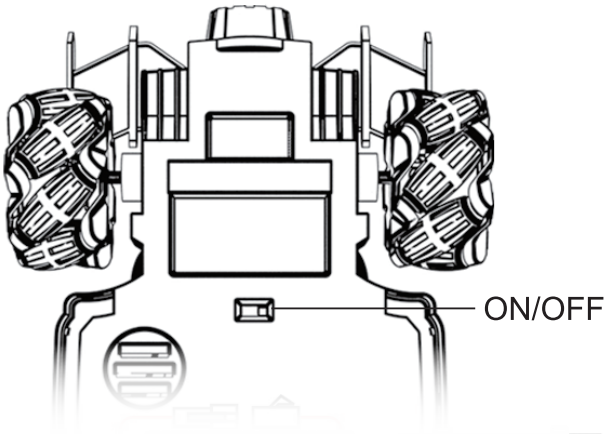

BASIC OPERATION

Turn the power switch on the bottom of the RC vehicle to the ON position. Then, turn the power switch on the remote control to the ON position.

Use the remote control to operate the vehicle.

If using the water vapor feature, fill the water chamber on the top of the vehicle with distilled water. Distilled water will prevent mineral build-up.

When the vehicle starts to lose performance, power, or function, it may be time to charge the vehicle battery and/or replace the remote batteries.

NOTE: If the vehicle is not responding to the remote control, the frequency signal may need to be reset. Turn the power switches on the remote and vehicle **OFF**. Remove and re-install the remote batteries. Turn the power switches on the vehicle and remote control **ON**.

REMOTE CONTROL FUNCTIONS

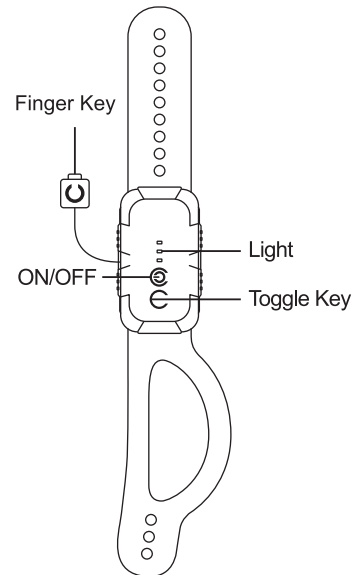
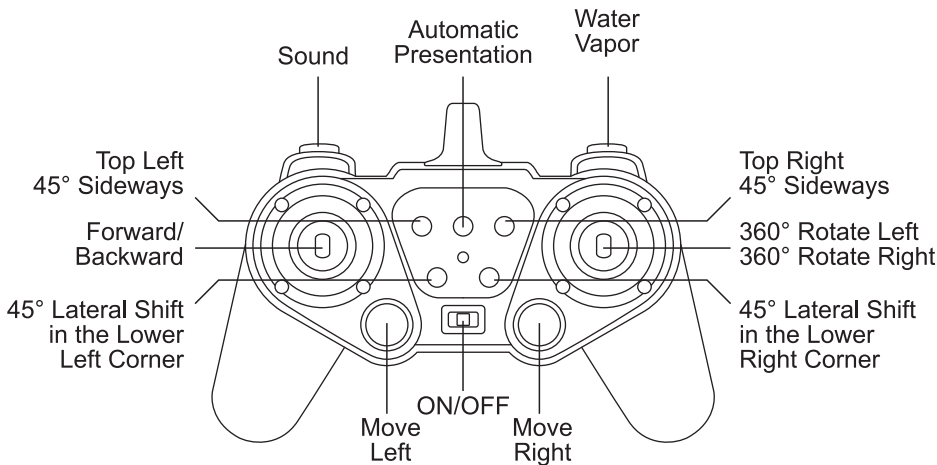

HANDHELD REMOTE

ON/OFF: Turns the remote ON/OFF.

Automatic Presentation: Activates demonstration mode.

Water Vapor: Press to turn on water vapor (lights turn ON simultaneously). Press again to turn water vapor off (lights turn OFF simultaneously). If this function is turned ON and no vapor is expelled, add more distilled water to the water chamber.

GESTURE REMOTE

ON/OFF: Turns the remote ON/OFF.

Finger Key:

Quick-press once to turn water vapor ON/OFF.

Quick-press twice to turn music ON/OFF.

Toggle Key:

Press lightly to activate demonstration mode.

Press 2-3 seconds to switch modes, turn left to left rotation, turn right to right rotation.

OPERATION

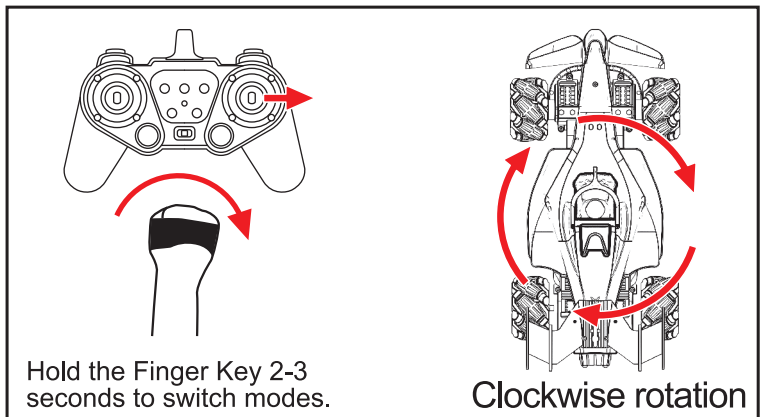
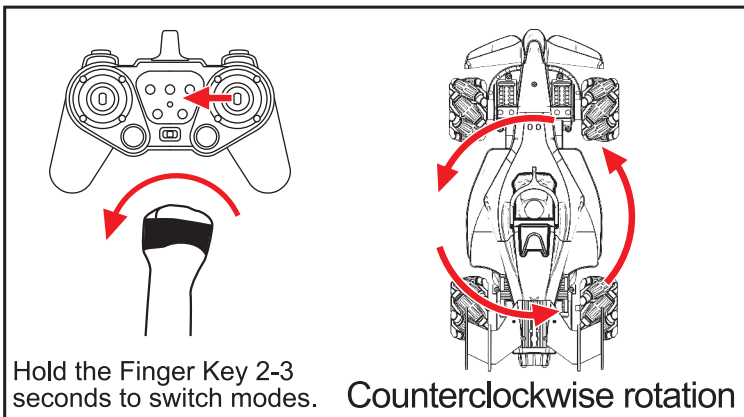
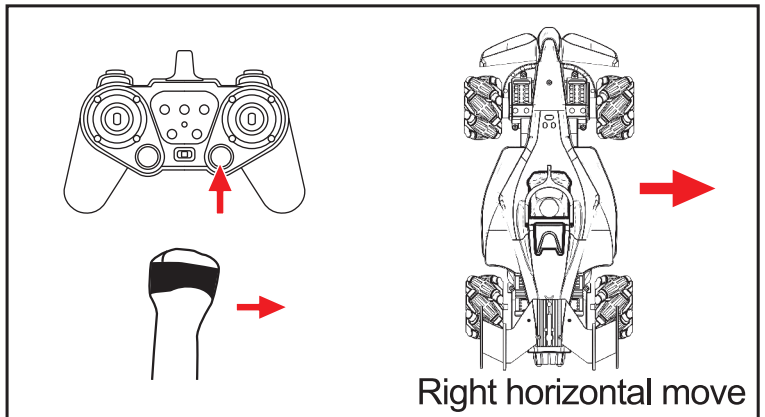
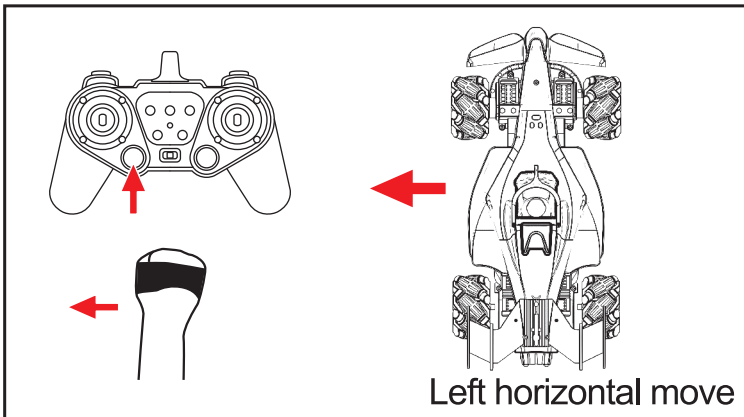
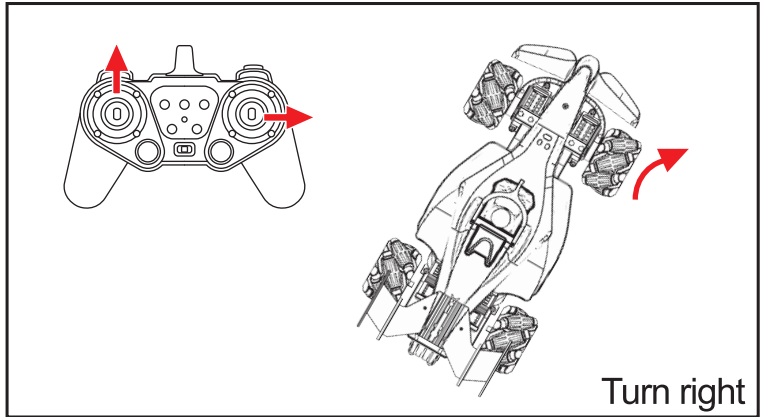
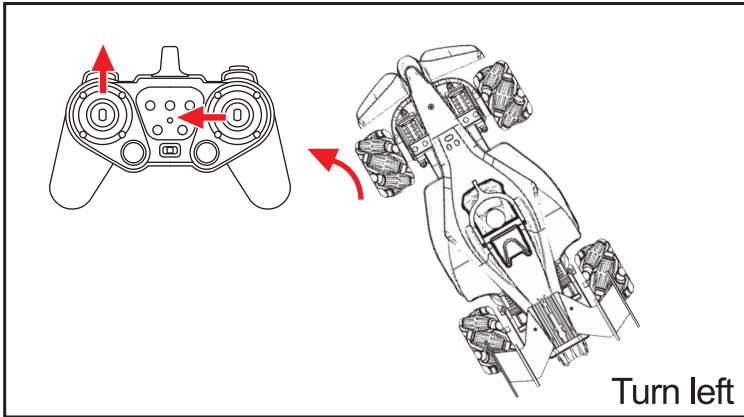
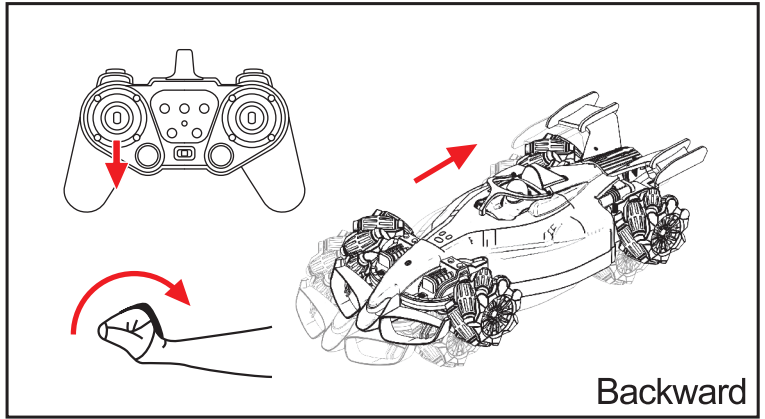
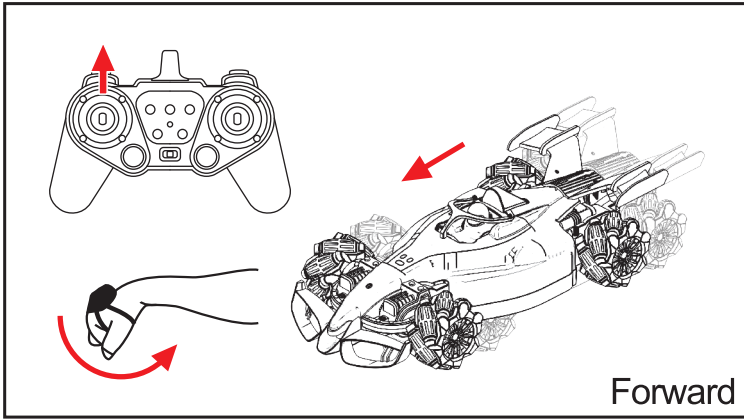

⚠ WARNING:

Manufacturer and seller expressly disclaim any and all liability from personal injury, property damage or loss, whether direct or indirect, or incidental, resulting from the incorrect attachment, improper use, inadequate maintenance, or neglect of this product.

CARE & MAINTENANCE

SAFE USE: Carefully review and follow all safety information.

CARE: Do not operate the vehicle in sand, water or snow. Do not submerge in water. Do not crash the vehicle into hard objects. Frequently inspect the vehicle and remotes for damage; immediately dispose of damaged and broken components.

CLEANING: Wipe soiled surfaces with a damp cloth. Do not use harsh chemicals or abrasive materials.

TROUBLESHOOTING

RC vehicle is not running.

Ensure the vehicle and remote power switches are turned ON. Make sure the vehicle battery pack is charged and the remote has good, fresh batteries that are installed following proper (+) and (-) battery placement.

RC vehicle is running intermittently.

Weak batteries will reduce the normal transmitting range of the remote control. Replace batteries in the remote control and charge the vehicle battery pack.

RC vehicle does not react, or reacts poorly to operation by controller.

High-frequency interference occurs near high-voltage lines, transformers and some types of buildings. Avoid areas that can cause frequency interference, choose another place to operate the RC vehicle.

Loss of control.

The RC vehicle is out of control range distance. Another RC vehicle using the same frequency is operating near your vehicle; avoid using two RC vehicles near each other.

Move to another place where radio frequency interference from another device or vehicle is not present.

SAFETY STATEMENTS & WARNINGS

- Not suitable for children under 6 years of age.
- To be used under direct supervision of a competent adult.
- Frequently inspect to ensure all components are in proper working order. Do not allow children to play with damaged or broken equipment.
- Do not allow children to change the batteries.
- Never use chemicals or abrasive materials to clean the unit.
- Store indoors when not in use.
- Promptly remove expelled batteries. Do not mix old and new batteries. Mixing batteries could cause leakage of the acid inside batteries, damaging the unit.
- Remove batteries before the unit is stored or if it will not be used for a long period of time.
- Only use compatible batteries. Incompatible batteries may damage the unit and void the warranty.

 This product uses a rechargeable battery. When the battery can no longer be used, it should be removed from the unit and recycled. The battery must not be incinerated or composted. Recycle the battery in accordance with local laws and regulations.

Any modification to the product or failure to follow recommended care will void the product warranty.

If you experience issues with the product or it was damaged during shipping, please contact our customer service team directly through one of the methods mentioned at the top of page 1.

Please have the item number and order information ready to expedite response time.

WARNING:

Manufacturer and seller expressly disclaim any and all liability from personal injury, property damage or loss, whether direct or indirect, or incidental, resulting from the incorrect attachment, improper use, inadequate maintenance, or neglect of this product.