

SIDES	BOTTOM
Material: Steel-C. R. S Galvanized	

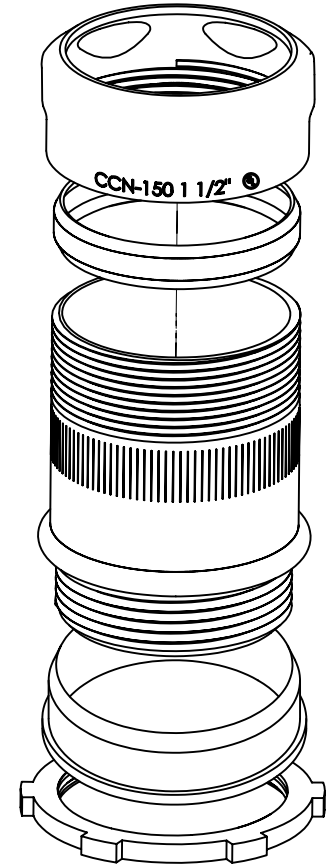
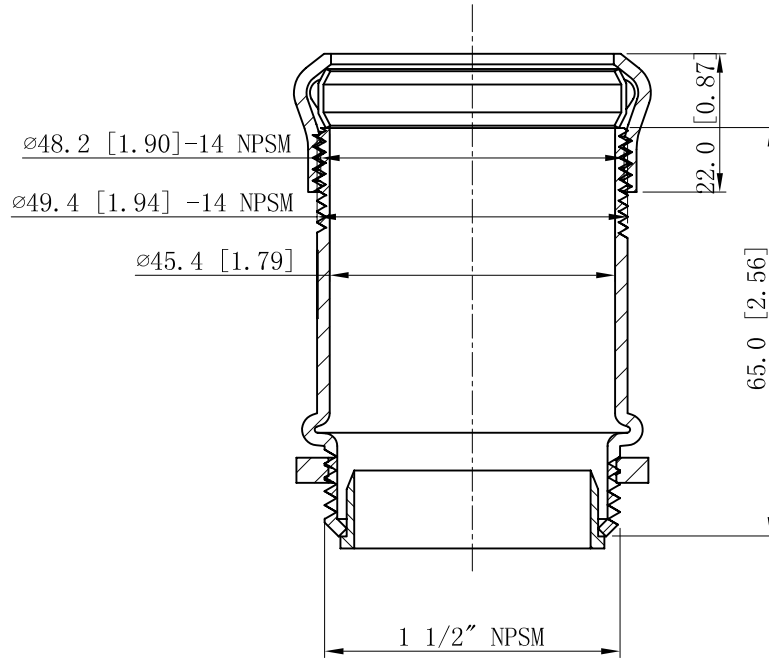
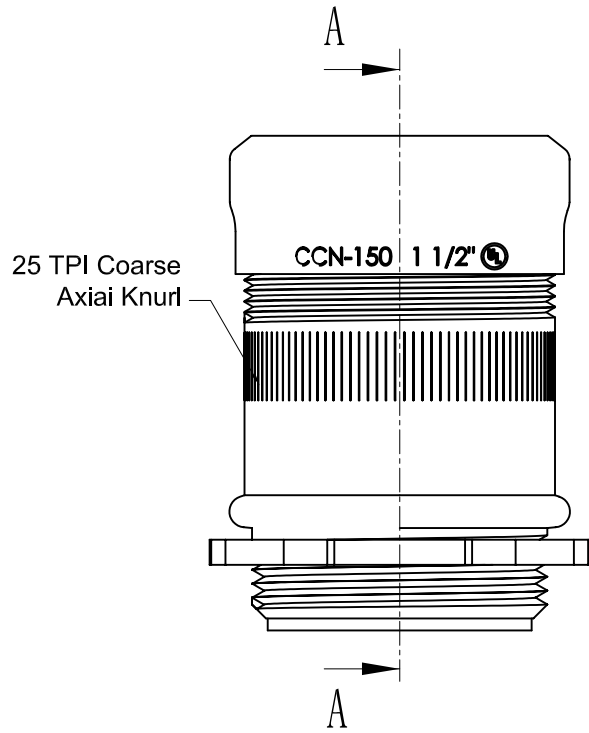

CUTAWAY VIEW A-A

This data sheet is for reference only .GARVIN INDUSTRIES reserves the right to make changes to the design without prior notice.

DESCRIPTION
TRADE REFERENCE TERMS

STANDARD PACKING
5 PCS

<b>GARVIN INDUSTRIES</b>		
TITLE STEEL EMT SET COMPRESSION CONNECTORS		
SIZE A4	DWG NO. CCN-150I	REV A
DATA SHEET		