

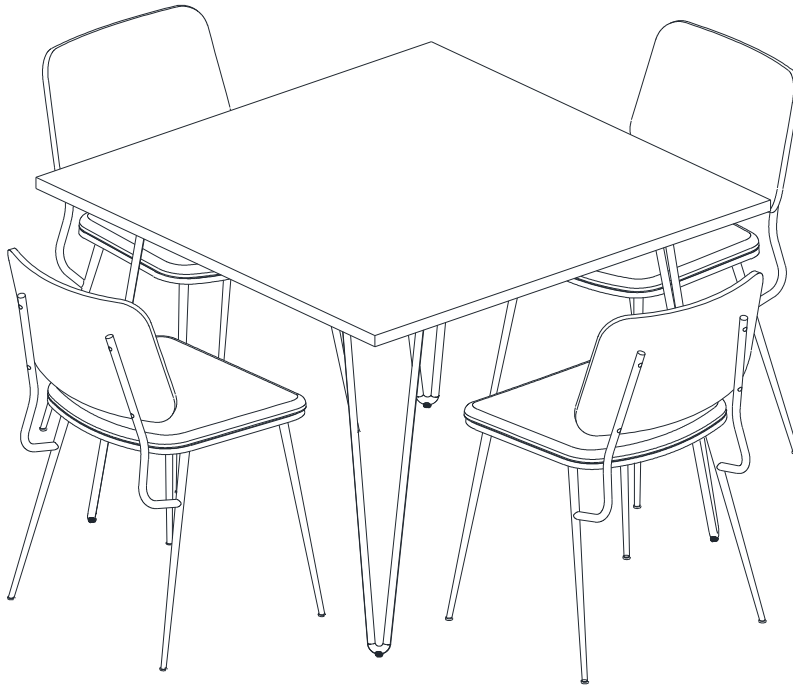

SIMPLIHOME®

Hayley / Hunter

5 Pc Dining Set

MODEL # HL5DS002HN42BLNL



brooklyn + max™ 

WyndenHall™
HOME DECOR

SIMPLIHOME®

Great quality is a right.

Thank you for shopping with Simpli Home,
America's top brand for high-value furniture.



It's time to register your product warranty.

It's quick and easy. And you'll be happy you did.

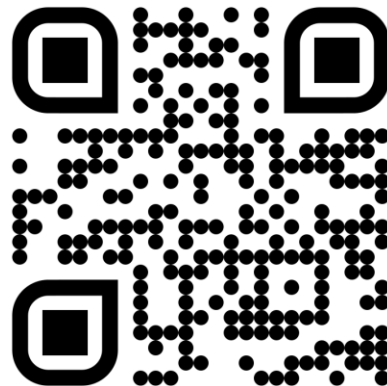

- ✓ Activate your **1-year** warranty.
- ✓ Automatic entry to win a **\$500** gift certificate.
- ✓ Earn instant rewards and **save**.

simpli-home.com/product-registration

SIMPLIHOME®

Review your product and collect rewards!

Thank you for your purchase! We hope you enjoy it. We'd love your feedback. Please share a review and get instant rewards!



simpli-home.com/product-review



Share photos and get your cash back!



Send us images or share them on social and qualify for instant rewards. You may even receive store credit on your entire purchase!

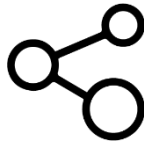

simpli-home.com/share-images

SIMPLIHOME®

For fastest customer service:

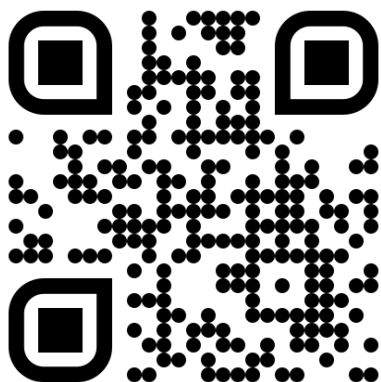

1. Open your phone's camera.
2. Point your phone's camera at the QR code to scan.
3. Click on the pop up.
4. You'll be taken to our customer service page.
5. Fill the form with your order information and issue.
6. Submit form.
7. A customer service associate will contact you.

Other ways to contact us...



Email Us

customerservice@simpli-home.com



Visit Us

Visit our site directly at
www.simpli-home.com



Call Us

1-866-518-0120
Monday to Friday
9am to 5pm EST

***If you've purchased from a retailer and you wish to return the product, please contact the retailer directly.**

IMPORTANT: Please read this manual carefully before beginning assembly of this product. Keep this manual for future reference.

Safety Information

This furniture is designed for indoor use.

Identify all the parts and hardware. Do not discard of the packaging until you have checked that you have all the parts and hardware required. Hardware package may have spare parts.

WARNING: This item contains small parts which can be swallowed by children and pets. Keep children and pets away during assembly. To avoid danger of suffocation, always keep plastic bags away from children and pets. We recommend that you assemble this unit on a carpeted floor to avoid scratches. If using power tools, set the tool to low torque to avoid damage.

May require 2 people for ease of assembly.

Care & Maintenance

Wipe regularly with clean water and a damp, clean, soft white cloth.

General cleaning can be done as needed with a mild detergent and water solution.

Always rinse with clean water and dry.

For heavy soiling, dampen a soft white cloth or soft bristle brush.

Use care as scrubbing can damage the surface.

More difficult stains can be treated, but this should be occasional, not daily cleaning.

ANY cleaning solution used must be removed with clean water and a clean white cloth.

Cleaning residue left on the material can cause it to dry out and crack or affect the color.

DO NOT use any cleaners with corrosive ingredients (lye, acids or ammonia).

Care & Maintenance

This furniture is designed for indoor use.

Damage to furniture can come from temperature changes in relative humidity (RH) in our homes. Humid air oxidizes metal which results in rusting, corrosion, tarnishing and roughness. Wood absorbs water as relative humidity rises and falls, and in doing so it swells and shrinks.

To protect against the humidity effect, the metal is powder coated. The powder coat layer protects the metal from oxidizing, corrosion, tarnishing and scratching and keeps it looking good for years to come. The wood is sealed and lacquered to protect against humidity.

To help protect your furniture, follow these steps:

- Use a humidifier, preferably one with an automatic control system that can sense the humidity level and adjust itself accordingly
- Dust with a soft dry cloth
- Wipe up spills promptly
- Clean with a dry cloth
- Do not use abrasive cleaners, chemical solvents, strong detergents, cleaners with bleach, and furniture polish
- Use soft felt base coasters, placemats to help prevent scratches
- Keep furniture out of direct sunlight, which can cause cracking or roughness on the protective layer
- If it can be avoided, do not put furniture near heating vents
- Keep the furniture 3 to 4 inches away from the wall, giving heat and air space to circulate

SIMPLIHOME®

Hunter / Moreno / Diaz

42W Square Dining Table

MODEL # AXCHUN-DT-42SQ

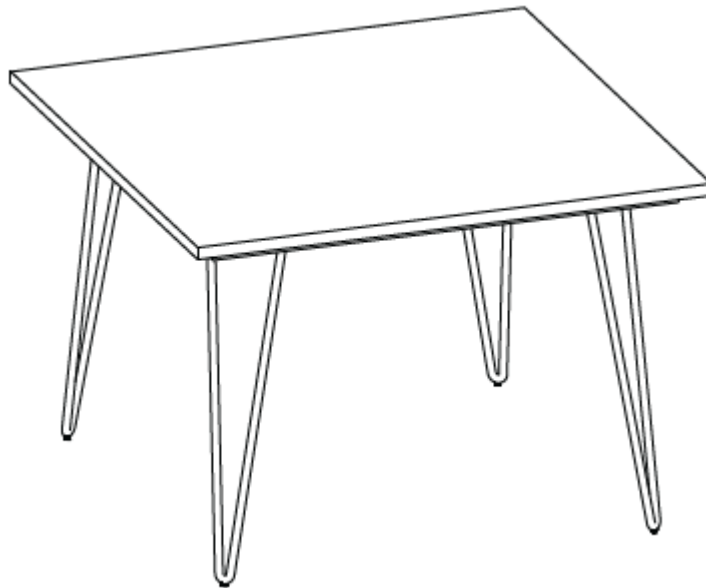

brooklyn + max™ 

WyndenHall™
HOME DECOR

Part Description

A

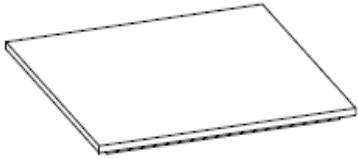

TOP
QTY 1

B

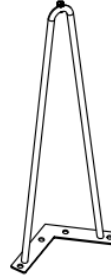

LEG
QTY 4

Hardware Description

1

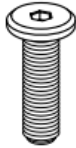

ALLEN KEY BOLT
M8 x 25 mm
QTY 16

2



WASHER
Ø 21 / Ø 9 x 2 mm
QTY 16

3



LOCK WASHER
Ø 15 / Ø 8.5 x 3 mm
QTY 16

4



ALLEN KEY
5 mm
QTY 1

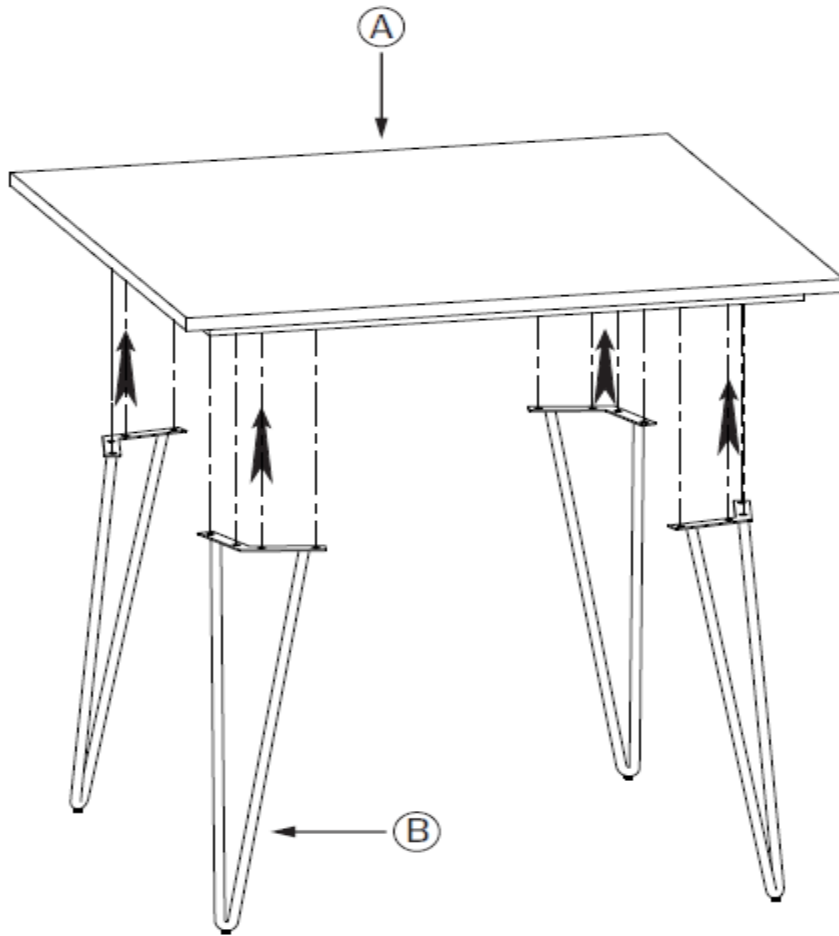

Step 1

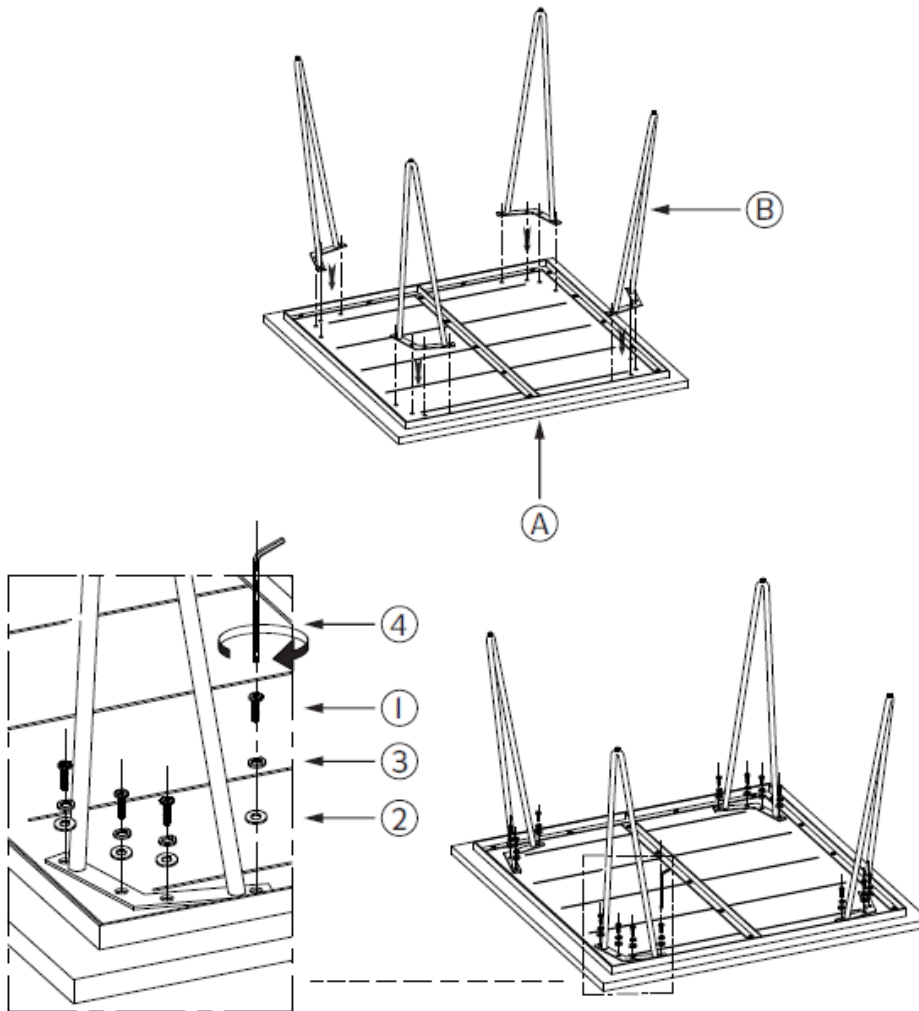

1. Place Top (A) upside down on a flat, smooth surface and align the Legs (B) with the holes on each corner of Top (A).
2. Use Allen Key Bolts (1), Washers (2) and Lock Washers (3) to attach Legs (B) to Top (A).
3. Use Allen Key (4) to tighten. Do not over-tighten.

Step 2

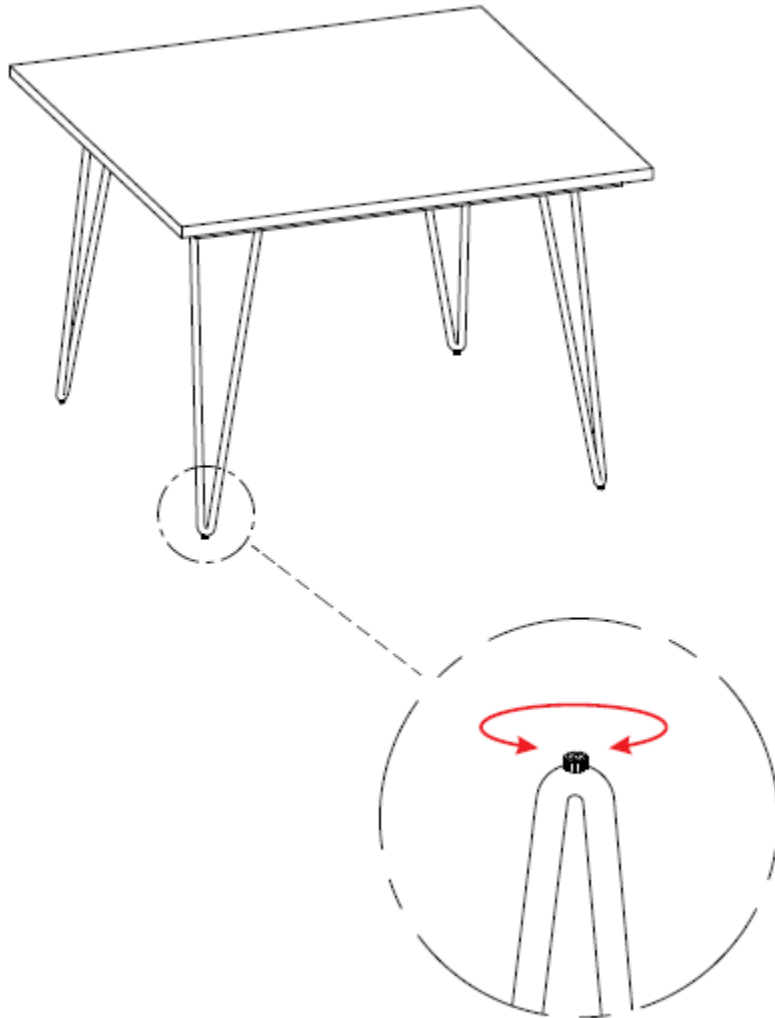

NOTE: Levelers on the bottom of the legs can be adjusted if floor is uneven.

SIMPLIHOME®

Hayley / Renata / Ellie

Dining Chair (Set of 2)

MODEL # AXCHALDC-BL

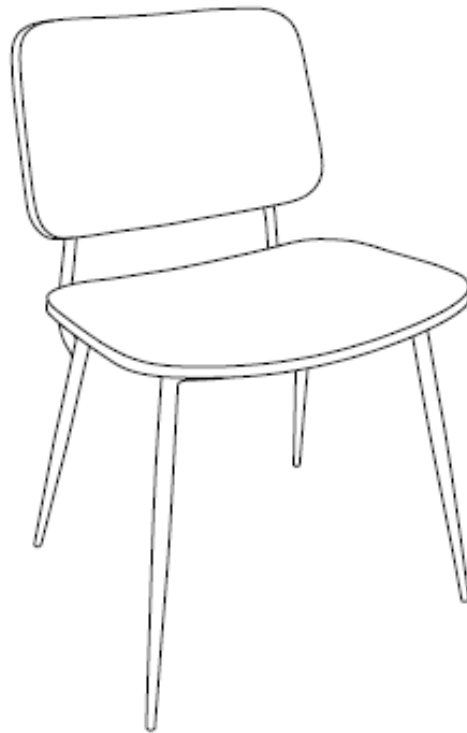

brooklyn + max™ 

WyndenHall™
HOME DECOR