

## INTELLIGENT UPS SERIES OR500LCDRM1U / OR700LCDRM1U USER MANUAL

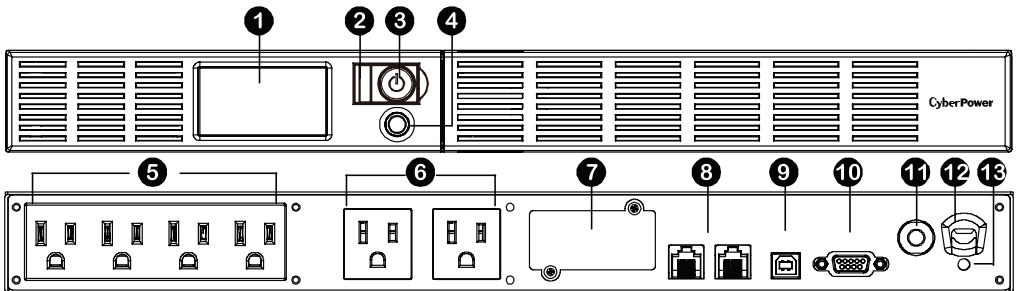

### FEATURES

1. LCD Module Display
2. Power On Indicator
3. Power Switch
4. LCD Function Selected Switch
5. Battery and Surge Protected Outlets
6. Full-Time Surge Protection Outlets
7. SNMP / HTTP Network Slot
8. Communication Protection Ports RJ45
9. USB Port to PC
10. Dry Contact
11. Circuit Breaker
12. AC Input
13. Electrical Wiring Fault Indicator (Red)

---

## PRODUCT REGISTRATION

Thank you for purchasing a CyberPower product. This UPS is designed to provide unsurpassed power protection, operation, and performance during the lifetime of the product. Please take a few minutes to register your product at: [www.CyberPowerSystems.com/registration](http://www.CyberPowerSystems.com/registration). Registration certifies your product's warranty, confirms your ownership in the event of a product loss or theft, and entitles you to free technical support. Register your product now to receive the benefits of CyberPower ownership.

---

## IMPORTANT SAFETY WARNINGS (SAVE THESE INSTRUCTIONS)

This manual contains important safety instructions. Please read and follow all instructions carefully during installation and operation of the unit. Read this manual thoroughly before attempting to unpack, install, or operate your UPS.

**CAUTION!** To prevent the risk of fire or electric shock, install in a temperature and humidity controlled indoor area free of conductive contaminants. (Please see specifications for acceptable temperature and humidity range).

**CAUTION!** To reduce the risk of electric shock, do not remove the cover except to service the battery. Turn off and unplug the unit before servicing the batteries. There are no user serviceable parts inside except for the battery.

**CAUTION!** Hazardous live parts inside can be energized by the battery even when the AC input power is disconnected.

**CAUTION!** The UPS must be connected to an AC power outlet with fuse or circuit breaker protection. Do not plug into an outlet that is not grounded. If you need to de-energize this equipment, turn off and unplug the unit.

**CAUTION!** To avoid electric shock, turn off the unit and unplug it from the AC power source before installing a computer component.

**CAUTION!** To reduce the risk of fire, connect only to a circuit provided with 20 amperes maximum branch circuit over current protection in accordance with the National Electric Code, ANSI/NFPA 70.

**CAUTION!** Not for use in a computer room as defined in the Standard for the Protection of Electronic Computer/Data Processing Equipment, ANSI/NFPA 75.

**CAUTION!** Do not dispose of batteries in a fire. The batteries may explode.

**CAUTION!** Do not open or mutilate batteries. Released electrolyte is harmful to the skin and eyes. It may be toxic.

### **DO NOT USE FOR MEDICAL OR LIFE SUPPORT EQUIPMENT!**

CyberPower Systems does not sell products for life support or medical applications. DO NOT use in any circumstance that would affect operation and safety of life support equipment, any medical applications or patient care.

### **DO NOT USE WITH OR NEAR AQUARIUMS!**

To reduce the risk of fire or electric shock, do not use with or near an aquarium. Condensation from the aquarium can cause the unit to short out.

### **DO NOT USE THE UPS ON ANY TRANSPORTATION!**

To reduce the risk of fire or electric shock, do not use the unit on any transportation such as airplanes or ships. The effect of shock or vibration caused during transit and the damp environment can cause the unit to short out.

# INSTALLING YOUR UPS SYSTEM

## UNPACKING

Inspect the UPS upon receipt.

The box should contain the following:

- (a) UPS unit
- (b) User's manual
- (c) Rack mount brackets
- (d) USB A+B type cable

PowerPanel® Personal software is available on our website. Please visit [www.cyberpowersystems.com](http://www.cyberpowersystems.com) and go to the Software Section for a free download.

## OVERVIEW

The OR500LCDRM1U/OR700LCDRM1U provides automatic voltage regulation for inconsistent utility power. The OR500LCDRM1U / OR700LCDRM1U features 1030 Joules of surge protection, and provides battery backup during power outages.

The OR500LCDRM1U / OR700LCDRM1U ensures consistent power to your computer system and its included software will automatically save your open files and shutdown your computer system during a utility power loss.

## AUTOMATIC VOLTAGE REGULATOR

The OR500LCDRM1U/OR700LCDRM1U stabilizes inconsistent utility power. The incoming utility power may be damaging to important data files, but with Automatic Voltage Regulation, the computer will not experience damaging voltage levels. An Automatic Voltage Regulator automatically increases low voltage to a consistent, computer safe 110v/120v. The unit's powerful sealed lead-acid batteries will provide power only if the incoming voltage drops below 90v or increases above 140v.

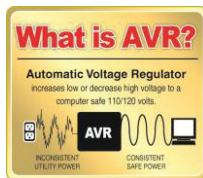

## DETERMINE THE POWER REQUIREMENTS OF YOUR EQUIPMENT

1. Ensure that the equipment plugged into the UPS does not exceed the UPS unit's rated capacity. If the rated capacities of the unit are exceeded, an overload condition may occur and cause the UPS unit to shut down or the circuit breaker to trip.

2. There are many factors that can affect the amount of power that your electronic equipment will require. For optimal system performance keep the load below 80% of the unit's rated capacity.

## HARDWARE INSTALLATION GUIDE

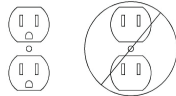
1. Your new UPS may be used immediately upon receipt. However, after receiving a new UPS, to ensure the battery's maximum charge capacity, it is recommended that you charge the battery for at least 8 hours. Your UPS is equipped with an auto-charge feature. When the UPS is plugged into an AC outlet, the battery will automatically charge whether the UPS is turned on or turned off.
2. If you will use the software, connect the USB cable to the USB port on the UPS.
3. With the UPS unit turned off and unplugged, connect your computer, monitor, and any other peripherals requiring battery backup into the battery power supplied outlets. Plug the other peripheral equipment (e.g. printer, scanner, speakers, etc.) into the full-time surge protection outlets. **DO NOT plug a laser printer, paper shredder, copier, space heater, vacuum cleaner, sump pump, or other large electrical device into the "Battery and Surge Protected Outlets". The power demands of these devices will overload and possibly damage the unit.**
4. Plug the UPS into a 2-pole, 3-wire grounded receptacle (wall outlet). Make sure the wall branch outlet is protected by a fuse or circuit breaker and does not service equipment with large electrical demands (e.g. air conditioner, refrigerator, copier, etc.). The warranty prohibits the use of extension cords, outlet strips, and surge strips in conjunction with the UPS unit.
5. Press the power switch to turn the unit on. The Power On indicator light will illuminate green and the unit will "beep" twice.

- continued

---

## INSTALLING YOUR UPS SYSTEM - continued

6. If an overload is detected, an audible alarm will sound and the unit will emit one long beep. To correct this, turn the UPS off and unplug at least one piece of equipment from the battery power supplied outlets. Make sure the circuit breaker is depressed and then turn the UPS on.
7. To maintain optimal battery charge, leave the UPS plugged into an AC outlet at all times.
8. To store the UPS for an extended period of time, cover it and store with the battery fully charged. While in storage, recharge the battery every three months to ensure optimal battery life.
9. The socket-outlet shall be installed near the equipment and shall be easily accessible.

---

## BASIC OPERATION

### 1. LCD module display

LCD shows all the UPS information with icons and messages.

### 2. Power On Indicator

This LED is illuminated when the utility condition is normal and the UPS outlets are providing power, free of surges and spikes.

### 3. Power Switch

Master on/off switch for equipment connected to the battery power supplied outlets.

### 4. LCD function selected switch

The switch can be used to select the LCD display contents including input/output voltage and estimated run time, etc.

### 5. Battery and Surge Protected Outlets

The unit has four battery powered/surge suppression outlets for connected equipment to ensure temporary uninterrupted operation of your equipment during a power failure. (DO NOT plug a laser printer, paper shredder, copier, space heater, vacuum cleaner, sump pump or other large electrical devices into the "Battery and Surge Protected Outlets". The power demands of these devices may overload and damage the unit.)

### 6. Full-Time Surge Protection Outlets

The unit has two surge suppression outlets.

### 7. SNMP/HTTP Network Slot

Remove the cover panel to install an optional RMCARD provides remote monitoring and management of your UPS over a network.

### 8. Communication Protection Ports RJ45

Communication protection ports, bi-directional, will protect a 10/100/1000 Ethernet connection. (RJ45).

### 9. USB Port to PC

This port allows connection and communication from the USB port on the computer to the UPS unit. The UPS communicates its status to the PowerPanel® Business Edition software.

### 10. Dry contact

This port produces information for equipment that can read dry contact signals.

### 11. Circuit Breaker

Located on the back of the UPS, the circuit breaker serves to provide overload and fault protection. Under normal operating conditions, the circuit breaker is depressed.

### 12. AC Input

Connect the AC Power cord to a properly wired and grounded outlet.

### 13. Electrical Wiring Fault Indicator (Red)

This LED indicator will illuminate to warn the user that a wiring problem exists, such as bad ground, missed ground or reversed wiring. If this is illuminated, disconnect all electrical equipment from the outlet and have an electrician check to ensure the outlet is properly wired. The unit will not provide surge protection without being plugged into a grounded and properly wired wall outlet.

## REPLACING THE BATTERY

**CAUTION!** Read and follow the IMPORTANT SAFETY INSTRUCTIONS before servicing the battery. Service the battery under the supervision of personnel knowledgeable of batteries and their precautions.

**CAUTION!** When replacing batteries, replace with the same number of the following battery: CyberPower/RB0670X2 for OR500LCDRM1U and CyberPower/ RB0690X2 for OR700LCDRM1U. See your dealer for replacement batteries.

**CAUTION!** Risk of energy hazard, 6V, maximum 8AH battery. Before replacing batteries, remove conductive jewelry such as chains, wrist watches and rings. High energy thorough conductive

**CAUTION!** Risk of explosion if battery is replaced by an incorrect type. Dispose of used batteries according to the instructions.

**CAUTION!** The battery may present the risk of electrical shock. Do not dispose of batteries in a fire, the batteries may explode. Follow all local ordinances regarding proper disposal of batteries.

**CAUTION!** Do not open or mutilate the batteries. Released material is harmful to the skin and eyes and may be toxic.

### BATTERY REPLACEMENT PROCEDURE:

1. Remove the right-side of the faceplate.
2. Remove the three retaining screws on the cable protection cover then remove the cover.
3. Disconnect the black and red cable.
4. Remove the retaining screw of the cable connectors.
5. Replace the new battery pack. Assemble the screws, cover, cable and front panel in the reverse sequence of above steps. Recharge the unit for 8 hours to ensure the UPS performs expected runtime.

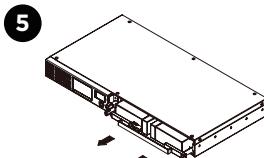
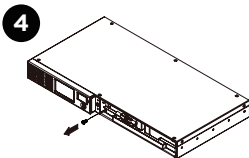
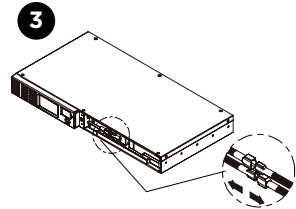
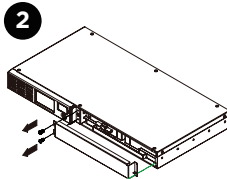
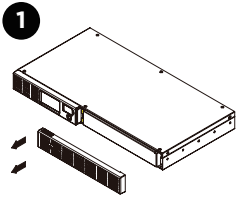

**CAUTION!** A battery can present a high risk of short circuit current and electrical shock. Take the following precautions before replacing the battery:

1. Remove all watches, rings or other metal objects.
2. Only use tools with insulated handles.
3. DO NOT lay tools or other metal parts on top of battery or any battery terminals.
4. Wear rubber gloves and boots.
5. Determine if the battery is inadvertently grounded. If inadvertently grounded, remove source of ground.

**CONTACT WITH A GROUNDED BATTERY CAN RESULT IN ELECTRICAL SHOCK!** The likelihood of such shock will be reduced if such grounds are removed during installation and maintenance (applicable to a UPS and a remote battery supply not having a grounded circuit).

**CAUTION - RISK OF EXPLOSION IF BATTERY IS REPLACED BY AN INCORRECT TYPE. DISPOSE OF USED BATTERIES ACCORDING TO LOCAL REGULATIONS**

**REMINDER:** Batteries are considered **HAZARDOUS WASTE** and must be disposed of properly. Most retailers that sell lead-acid batteries collect used batteries for recycling, as required by local regulations.

## DEFINITIONS FOR ILLUMINATED LCD INDICATORS

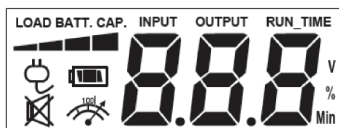

### Line Mode

Select SW Press	UPS Status Display				Capacity Display		Digital Value Display				
					Load Cap.	Battery Cap	Input Voltage	Output Voltage	% of Load	% of Batt.	Run Time
Initial	V	X	—	X	V	X	V				
1st	V	X	—	X	V	X		V			
2nd	V	X	—	X	V	X			V		
3rd	V	X	—	X	X	V				V	
4th	V	X	—	X	V	X					V
5th (Return)	V	X	—	X	V	X	V				
(Overload)	V	X	—	V	—	—	—	—	—	—	—

V : Illuminated / X : Not Illuminated / — : Either

### Battery Mode

Select SW Press	UPS Status Display				Capacity Display		Digital Value Display				
					Load Cap.	Battery Cap	Input Voltage	Output Voltage	% of Load	% of Batt.	Run Time
Initial	X	V	—	X	X	V	V				
1st	X	V	—	X	X	V		V			
2nd	X	V	—	X	V	X			V		
3rd	X	V	—	X	X	V				V	
4th	X	V	—	X	X	V					V
5th (Return)	X	V	—	X	X	V	V				
(Overload)	X	V	—	V	—	—	—	—	—	—	—

V : Illuminated / X : Not Illuminated / — : Either

## TROUBLESHOOTING

Problem	Possible Cause	Solution
Full-time surge protection outlets stop providing power to equipment.	Circuit breaker has been tripped due to an overload.	Turn the UPS off and unplug at least one piece of equipment. Wait 10 seconds, reset the circuit breaker by depressing the button, and then turn the UPS on.
The UPS does not perform expected runtime.	Battery not fully charged.	Recharge the battery by leaving the UPS plugged in.
	Battery is worn out.	Contact CyberPower Systems about replacement batteries at: <a href="http://cyberpowersystems.com/support">cyberpowersystems.com/support</a> .
The UPS will not turn on.	The on/off switch is designed to prevent damage from rapidly turning it off and on.	Turn the UPS off. Wait 10 seconds and then turn the UPS on.
	The battery is worn out.	Contact CyberPower Systems about replacement batteries at: <a href="http://cyberpowersystems.com/support">cyberpowersystems.com/support</a> .
	Mechanical problem.	Contact CyberPower Systems at: <a href="http://cyberpowersystems.com/support">cyberpowersystems.com/support</a> .
PowerPanel® Personal is inactive (all icons are gray).	The USB cable is not connected.	Connect the USB cable to the UPS unit and an open USB port on the back of the computer.
	The unit is not providing battery power.	Shutdown your computer and turn the UPS off. Wait 10 seconds and turn the UPS back on. This should reset the unit.

Additional troubleshooting information can be found at "Support" at [www.CyberPowerSystems.com](http://www.CyberPowerSystems.com)

## TECHNICAL SPECIFICATIONS

Model	OR500LCDRM1Ua	OR700LCDRM1Ua
Capacity	500VA / 300W	700VA / 400W
Nominal Input Voltage	90 Vac to 140 Vac	
Input Frequency	60 Hz $\pm$ 3 Hz (Auto-sensing)	
AVR Function	Yes	
On-Battery Output Voltage	120Vac $\pm$ 5%	
On-Battery Output Wave Form	Simulated Sine Wave Form	
Operating Temperature	+ 32°F to 104° F / 0° C to 40° C	
Operating Relative Humidity	0 to 90% NON-CONDENSING	
Size (W x H x D)	433 x 235 x 44 mm (1U Rack) / 17.05 x 9.25 x 1.75 in.	
Net Weight	16.5 lbs / 7.47 kg	17.3 lbs / 7.83 kg
Battery Type	CyberPower / RB0670X2	CyberPower / RB0690X2
Typical Battery Recharge Time	8 hours	
Typical Battery Life	3 to 6 years, depending on number of discharge/recharge cycles	
Recommended Battery	Sealed Maintenance Free Lead Acid Battery	
Safety Approvals	UL1778 4th, cUL CSA C22.2 No.107.3-05, FCC/DoC Class B	

## SYSTEM FUNCTION BLOCK DIAGRAM

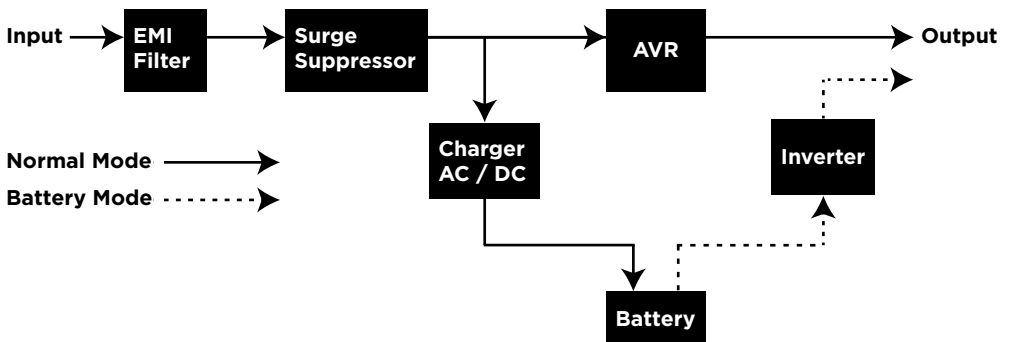



---

# CYBERPOWER GREENPOWER UPS™ TECHNOLOGY

## Advanced Energy-Saving Patented Bypass Technology

CyberPower's patented GreenPower UPS™ with Bypass Technology reduces UPS energy costs by up to 75% compared to conventional UPS models. Even when utility power is normal, conventional UPS models constantly pass power through a transformer. By contrast, under normal conditions the advanced circuitry of a GreenPower UPS™ bypasses the transformer. As a result, the power efficiency is significantly increased while decreasing waste heat, using less energy, and reducing energy costs. When an abnormal power condition occurs, the GreenPower UPS™ automatically runs power through its transformer to regulate voltage and provide "safe" power. Since utility power is normal over 88% of the time, the GreenPower UPS™ operates primarily in its efficient bypass mode. The GreenPower UPS™ is also manufactured in accordance with the Restriction on Hazardous Substances (RoHS) directive making it one of the most environmentally-friendly on the market today.



**GREENPOWER UPS™**  
Energy-Saving Technology

---

## FCC COMPLIANCE STATEMENT

This device complies with part 15 of the FCC rules. Operation is subject to the following two conditions: (1) this device may not cause harmful interference, and (2) this device must accept any interference received, including interference that may cause undesired operation.

Note: This equipment has been tested and found to comply with the limits for a Class B digital device, pursuant to part 15 of the FCC Rules. These limits are designed to provide reasonable protection against harmful interference in a residential installation. This equipment generates, uses, and can radiate radio frequency energy and, if not installed and used in accordance with the instructions, may cause harmful interference to radio communications. However, there is no guarantee that interference will not occur in a particular installation. If this equipment does cause harmful interference to radio or television reception, which can be determined by turning the equipment off and on, the user is encouraged to try to correct the interference by one or more of the following measures:

- Reorient or relocate the receiving antenna.
- Increase the separation between the equipment and receiver.
- Connect the equipment to an outlet on a circuit different from that to which the receiver is connected.
- Consult the dealer or an experienced radio/TV technician for help.

Warning: Changes or modifications not expressly approved by the party responsible for compliance could void the user's authority to operate the equipment.



### Canadian Compliance Statement

CAN ICES-3 (B)/NMB-3(B)

---

## LIMITED WARRANTY AND CONNECTED EQUIPMENT GUARANTEE

Please visit [www.CyberPowerSystems.com](http://www.CyberPowerSystems.com) for a copy of the Limited Warranty and Connected Equipment Guarantee.

### Where Can I Get More Information?

The application of the United Nations Convention of Contracts for the International Sale of Goods is expressly excluded. CyberPower is the warrantor under this Limited Warranty.

For further information please feel free to contact CyberPower at:

Cyber Power Systems (USA), Inc. 4241 12th Ave E., STE 400, Shakopee, MN 55379;

call us at **(877) 297-6937**; or submit a web ticket online at [cyberpowersystems.com/support](http://cyberpowersystems.com/support).

Cyber Power Systems (USA), Inc. encourages environmentally sound methods for disposal and recycling of its UPS products. Please dispose and/or recycle your UPS and batteries in accordance to the local regulations of your state.

**WARNING:** This product can expose you to chemicals including bisphenol A (BPA) and styrene, which is known to the State of California to cause reproductive harm and cancer. For more information, go to [www.P65Warnings.ca.gov](http://www.P65Warnings.ca.gov).