

Assembly Guide

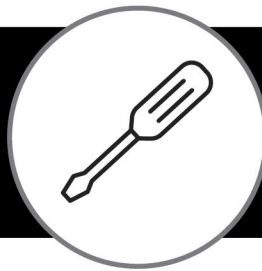

If you're having any difficulty during assembly of this product, don't hesitate to call us at **1-800-950-4782.**

Our customer service experts are trained to provide step-by-step instruction and can easily replace any missing or damaged parts.

Representatives are available Monday-Friday from 8:30 a.m. to 7:30 p.m. (ET)

5 Shelf Bookcase

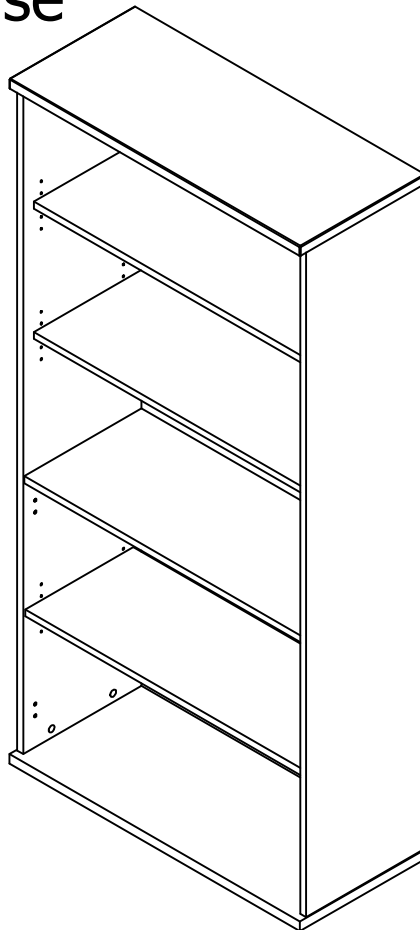

Lot Code #

Instruction Sheet Number A173226H

Keep manual for future reference.

For best results, keep these tips in mind:

- ① We know you want to finish this assembly as quickly as possible, but trust us: you'll have a better experience if you take it one step at a time.
- ② Give yourself some room to work near where you want the fully assembled product.
- ③ If your floor isn't carpeted, assemble this product on the empty carton to avoid scratching.
- ④ Do you have a friend who owes you a favor? Some steps may go a little easier with a second set of hands.

DOs

- ✔ Use a #2 Phillips head screwdriver (or other handheld tools as indicated)
- ✔ Wear safety glasses at all times during assembly
- ✔ Carefully follow the instructions in this guide and complete all steps in order
- ✔ Give us a call if you're having trouble with a particularly tricky step

DON'Ts

- ✘ We know power tools are quick and easy, but you shouldn't use them when assembling this product (unless otherwise specified)
- ✘ Never move your furniture with items inside or resting on the surface
- ✘ Do not attempt to use this product before all steps have been completed



Watch assembly videos right on your phone or computer!



Some steps include QR codes that link to helpful videos. Watch out for the icon below! Simply open up your smartphone camera to scan the code.

(Users of older smartphones may need to install a QR Reader.)

SCAN HERE



FOR VIDEOS

Or visit <https://www.bushbusinessfurniture.com/CustomerService/HowtoAssemble.aspx>

IMPORTANT SAFETY INFORMATION



PLEASE READ WARNINGS

Improper use can cause safety hazards, or damage to your furniture and household items.

Warning	Do	Don't	Why it's important
Serious injury may occur.	<ul style="list-style-type: none">Assemble following all instructions using all indicated parts and hardware provided.Install tip-over restraint provided.Install every indicated nail and/or screw.Verify furniture is stable on it's own.Place heaviest items in the lower drawers.Remove items that might tempt kids to climb, such as toys and remote controls from the top and upper shelves of furniture.	<ul style="list-style-type: none">Do not move unit when loaded.Do not load with a television or other heavy equipment.Do not exceed the maximum load limits stated in the instructions.Do not allow children to stand, climb, or hang on furniture.	Improper assembly, use or loading can lead to product instability, tipover, or collapse.

Advertencia	Hacer	No	Por qué es importante
Pueden producirse lesiones graves.	<ul style="list-style-type: none">Realice el montaje siguiendo todas las instrucciones y utilizando todas las piezas indicadas y los herrajes suministrados.Instale el sistema de retención antivuelco suministrado.Instale todos los clavos y/o tornillos indicados.Compruebe que el mueble sea estable por sí mismo.Coloque los objetos más pesados en los cajones inferiores.Retire los objetos que puedan tentar a los niños a trepar, como juguetes y mandos a distancia, de los estantes superiores y superiores del mueble.	<ul style="list-style-type: none">No mueva la unidad cuando esté cargada.No cargue el mueble con un televisor u otro equipo pesado.No supere los límites máximos de carga indicados en las instrucciones.No permita que los niños se pongan de pie, trepen o se cuelguen de los muebles.	El montaje, uso o carga inadecuados pueden provocar inestabilidad, vuelco o colapso del producto.

IMPORTANT SAFETY INFORMATION



PLEASE READ WARNINGS

Improper use can cause safety hazards, or damage to your furniture and household items.

Avertissement	À faire	À ne pas faire	Pourquoi c'est important
Peut entraîner des blessures graves.	<ul style="list-style-type: none">• Assembler en suivant toutes les instructions et en utilisant toutes les pièces et la quincaillerie incluses.• Installer le matériel de fixation mural inclus.• Installer tous les clous et/ou toutes les vis.• Assurez-vous que le meuble soit stable par lui-même.• Placer les objets les plus lourds dans les tiroirs du bas.• Retirer les objets qui pourraient inciter les enfants à grimper comme les jouets et les télécommandes des tablettes supérieures et du dessus du meuble.	<ul style="list-style-type: none">• Ne pas déplacer le meuble lorsqu'il est chargé.• Ne pas charger le meuble avec un téléviseur ou tout autre équipement lourd.• Ne pas dépasser les limites de poids maximales indiquées dans les instructions.• Ne pas laisser les enfants se tenir sur les meubles, y grimper ou s'y suspendre.	Un assemblage, une utilisation ou un chargement incorrects peuvent entraîner l'instabilité, le basculement ou l'effondrement du produit.

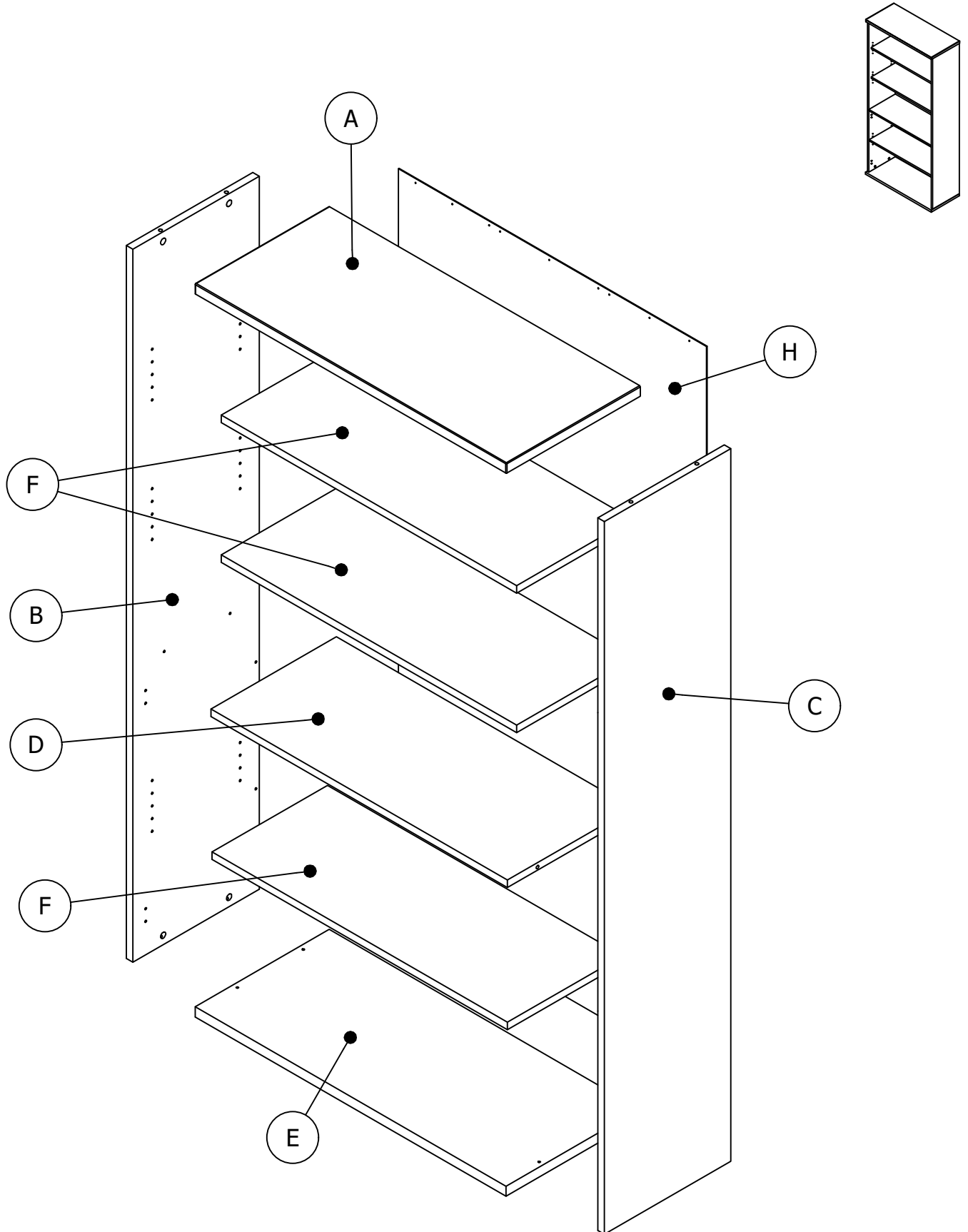

Have an assembly question or need a replacement part? Just call
1-800-950-4782, we are here to help.

Fasteners are shown actual size.

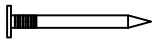
H34174  [49]
Nail 19mm

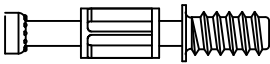
H72988  [12]
KD Bolt

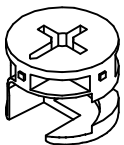
H71659  [12]
KD Cam

Hardware not to scale.

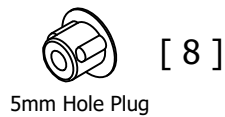
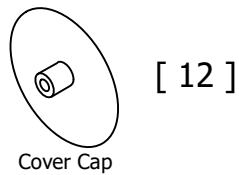
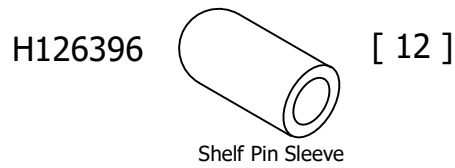
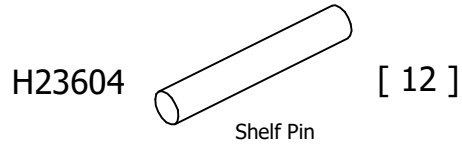

TIPOVER RESTRAINT HARDWARE

SUGERENCIA SOBRE HARDWARE DE RETENCIÓN
MATÉRIEL DE RETENUE SUR LE SUPPORT

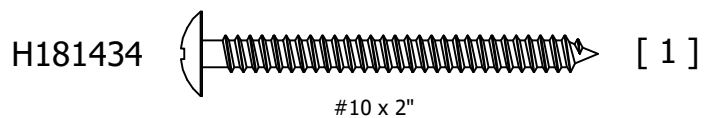
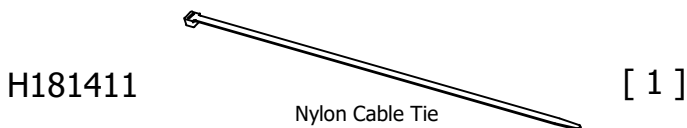
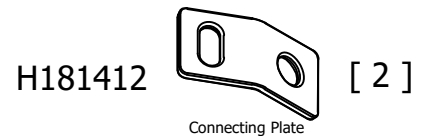
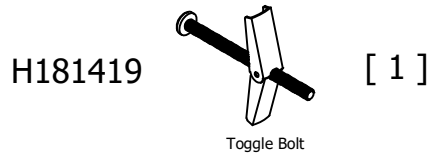
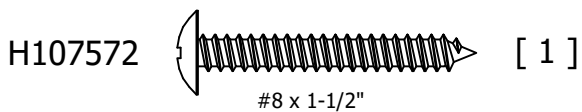

Have an assembly question or need a replacement part? Just call
1-800-950-4782, we are here to help.

STEP 1

Prepare Panels

A173226H

H72988

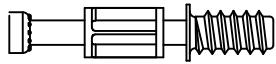

KD Bolt

[4]



5mm

[8]

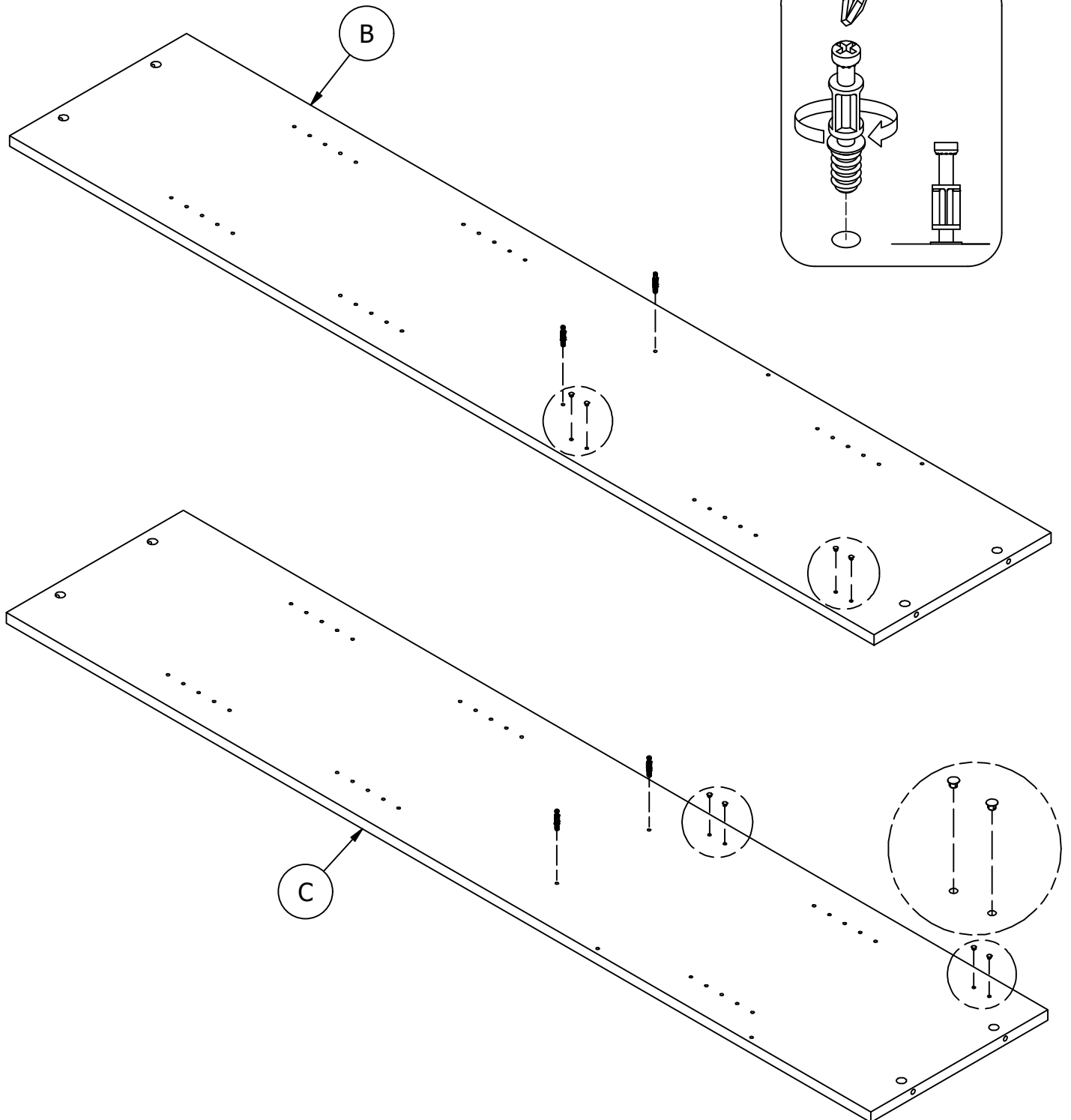

Have an assembly question or need a replacement part? Just call
1-800-950-4782, we are here to help.

STEP 2

Assemble Panels

A173226H

Scan QR Code to Watch Video on:



How to Tighten KD Cams

H71659

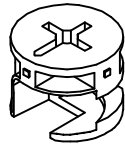

[2]

KD Cam

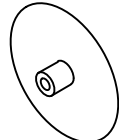

[2]

Cover Cap

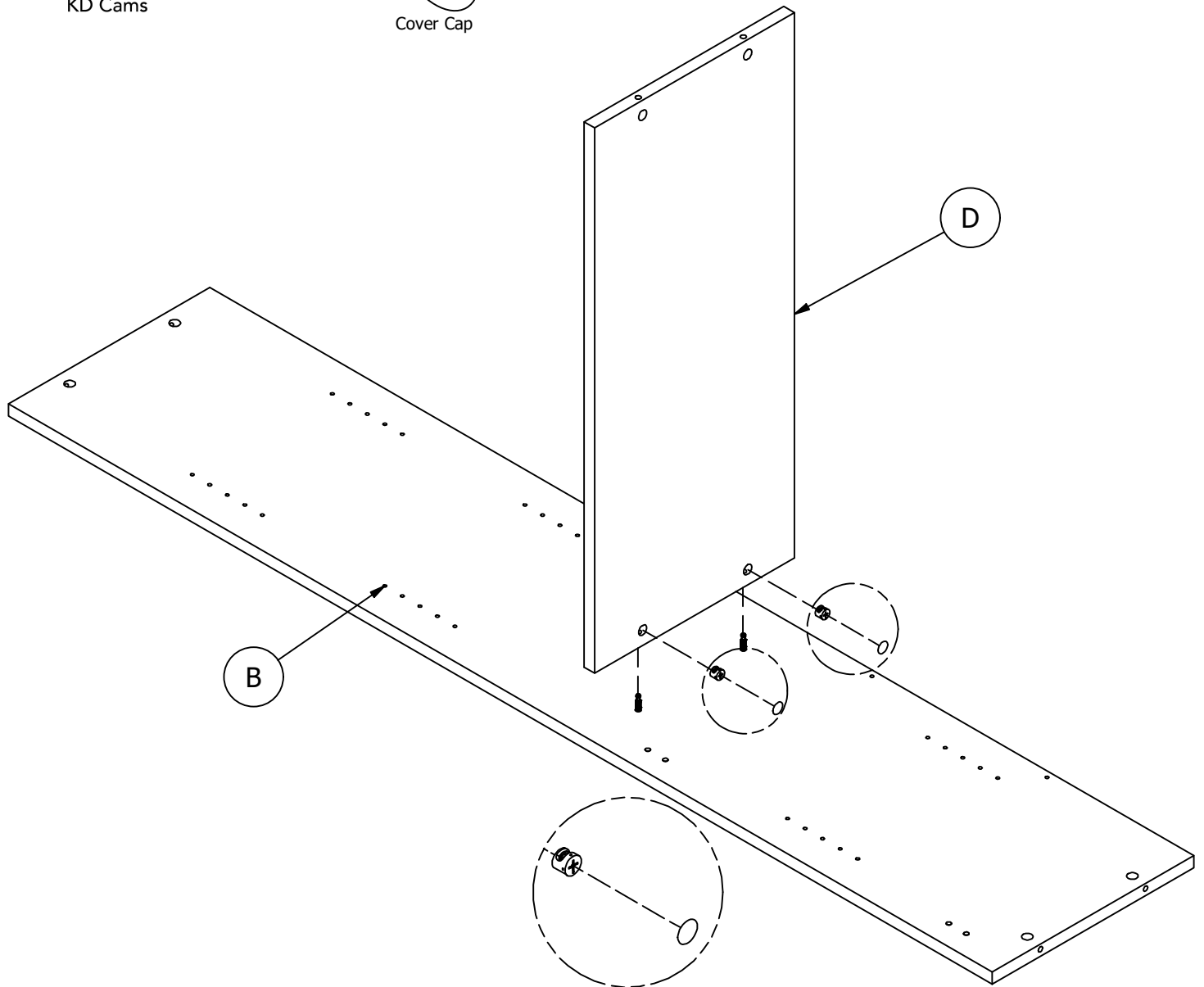
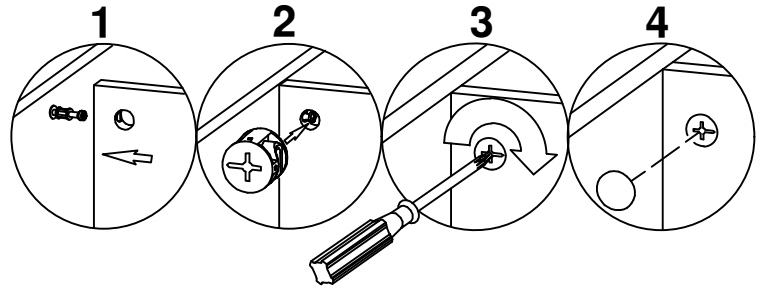

Have an assembly question or need a replacement part? Just call **1-800-950-4782**, we are here to help.

STEP 3

Assemble Panels

A173226H

Scan QR Code to Watch Video on:



How to Tighten KD Cams

H71659

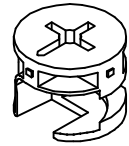

KD Cam

[2]

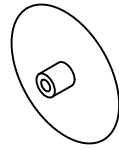

Cover Cap

[2]

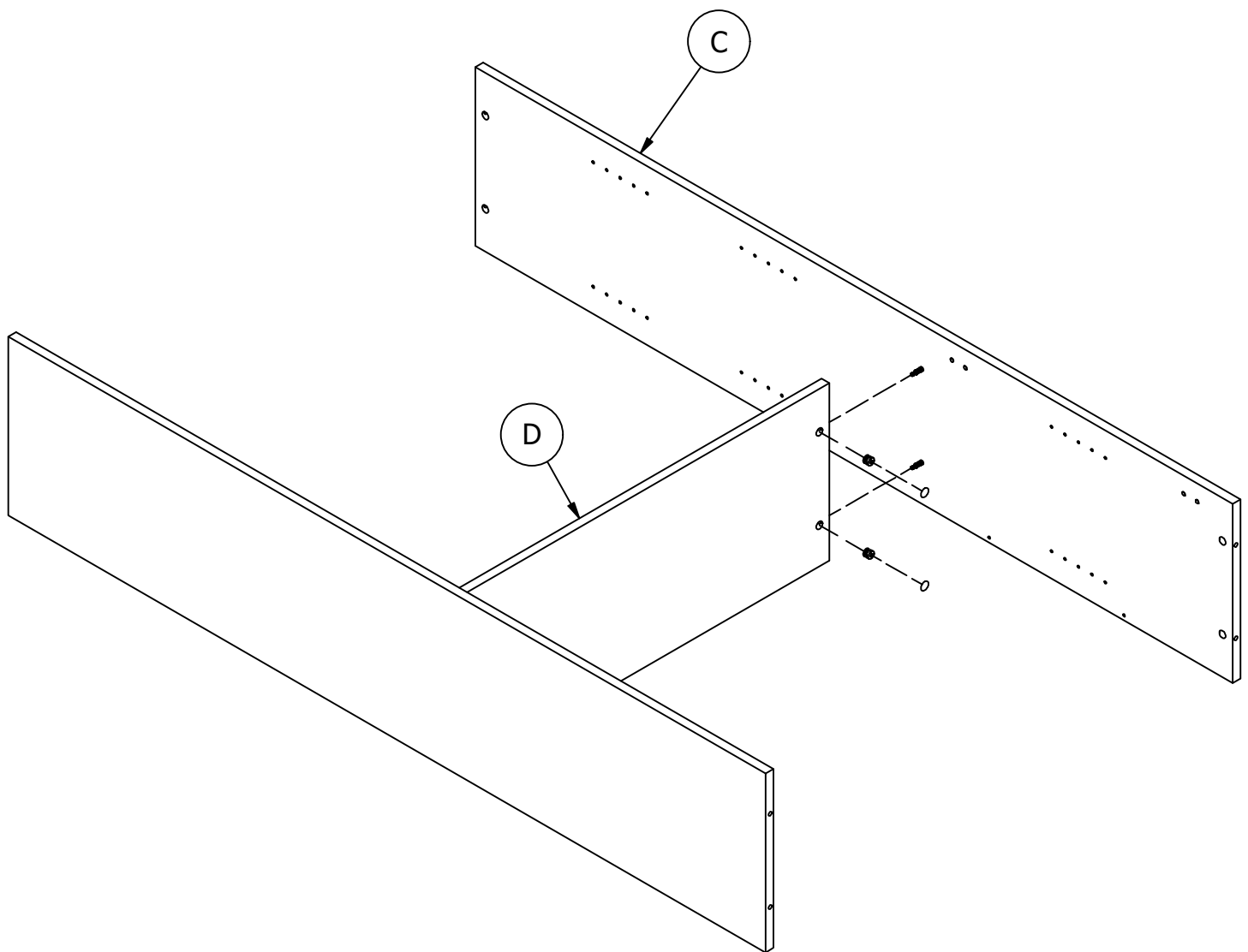
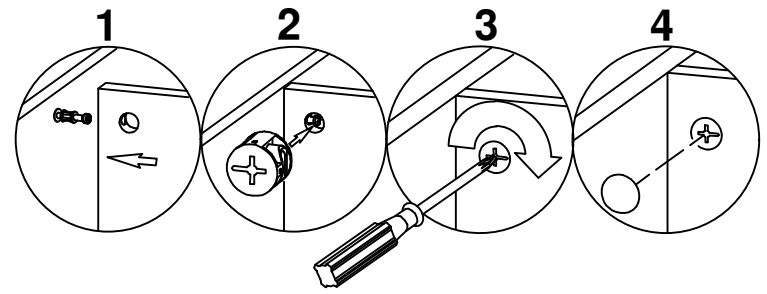

Have an assembly question or need a replacement part? Just call **1-800-950-4782**, we are here to help.

STEP 4

Prepare Panels

A173226H

H72988

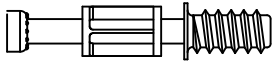

[8]

KD Bolt

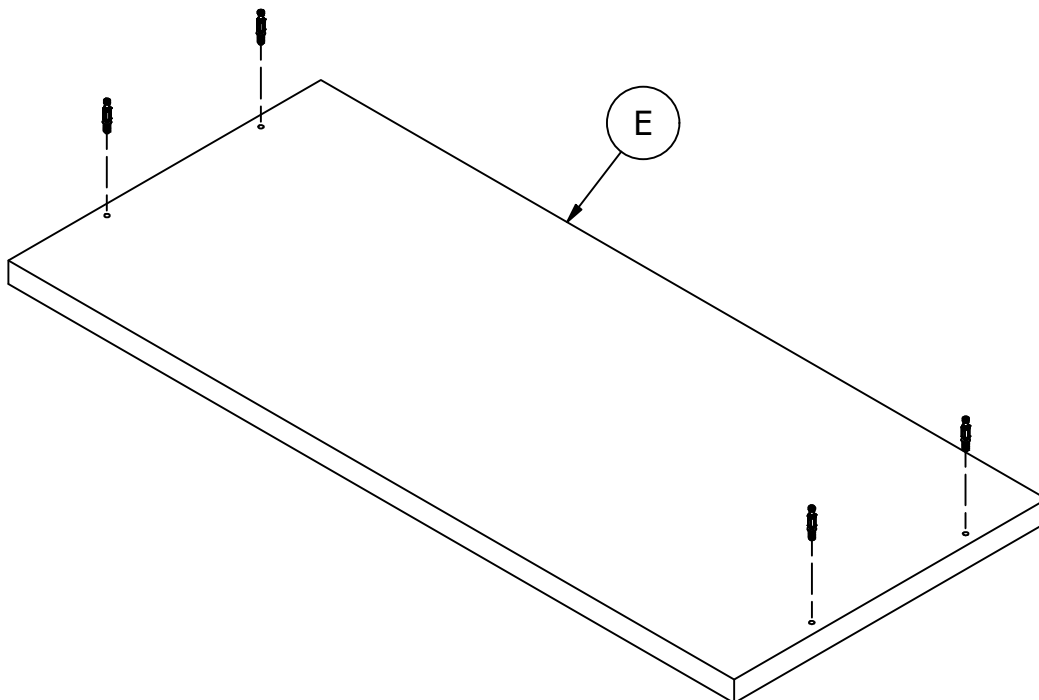
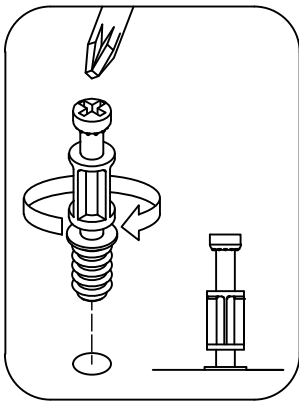
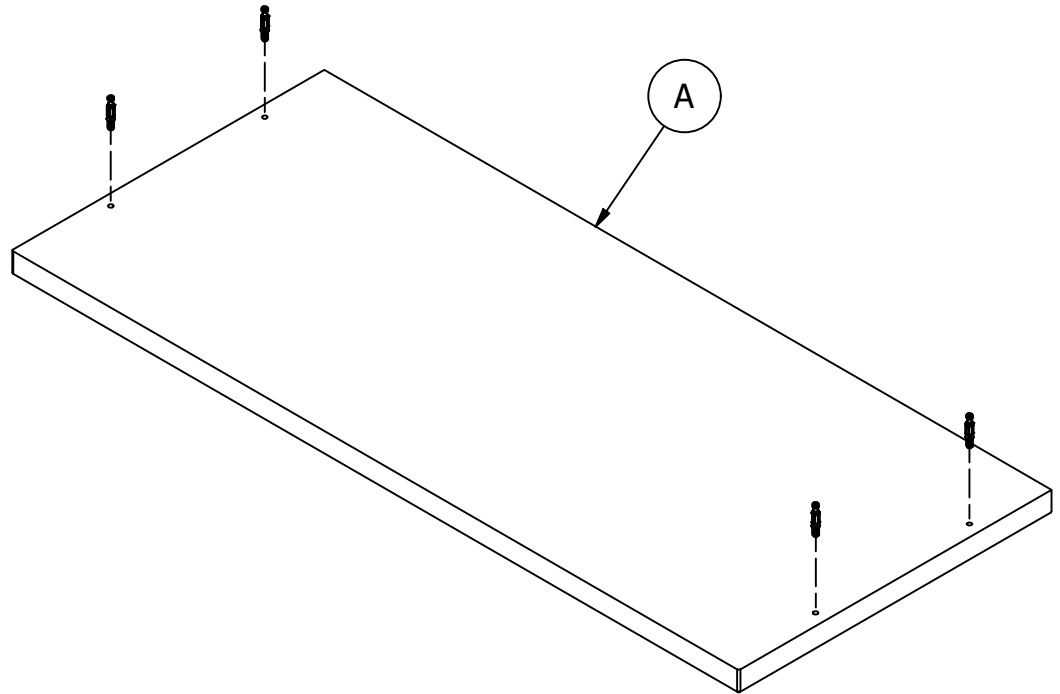

Have an assembly question or need a replacement part? Just call **1-800-950-4782**, we are here to help.

STEP 5

Assemble Panels

A173226H

Scan QR Code to Watch Video on:



How to Tighten KD Cams

H71659

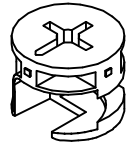

KD Cam

[4]

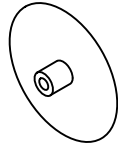

Cover Cap

[4]

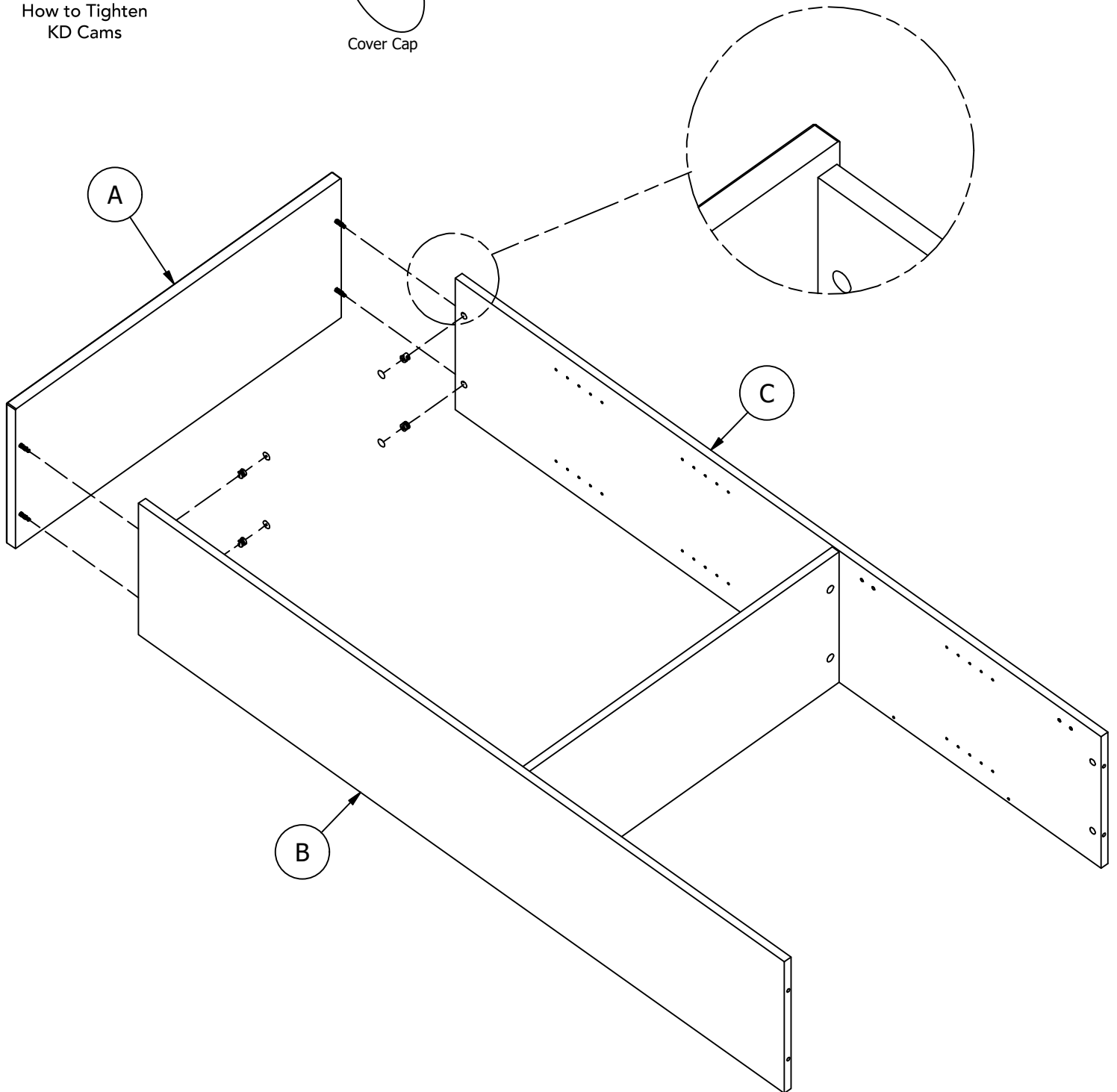
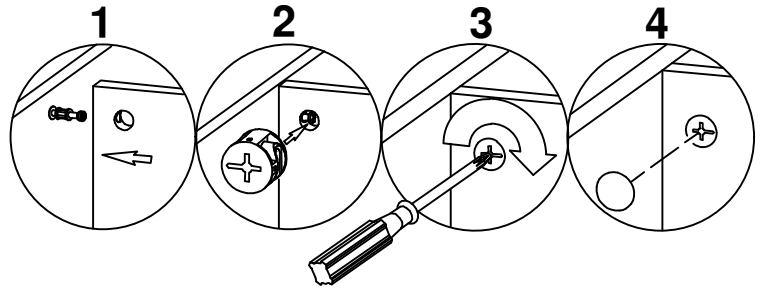

Have an assembly question or need a replacement part? Just call **1-800-950-4782**, we are here to help.

STEP 6

Assemble Panels

A173226H

Scan QR Code to Watch Video on:



How to Tighten KD Cams

H71659

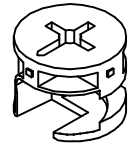

KD Cam

[4]

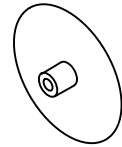

Cover Cap

[4]

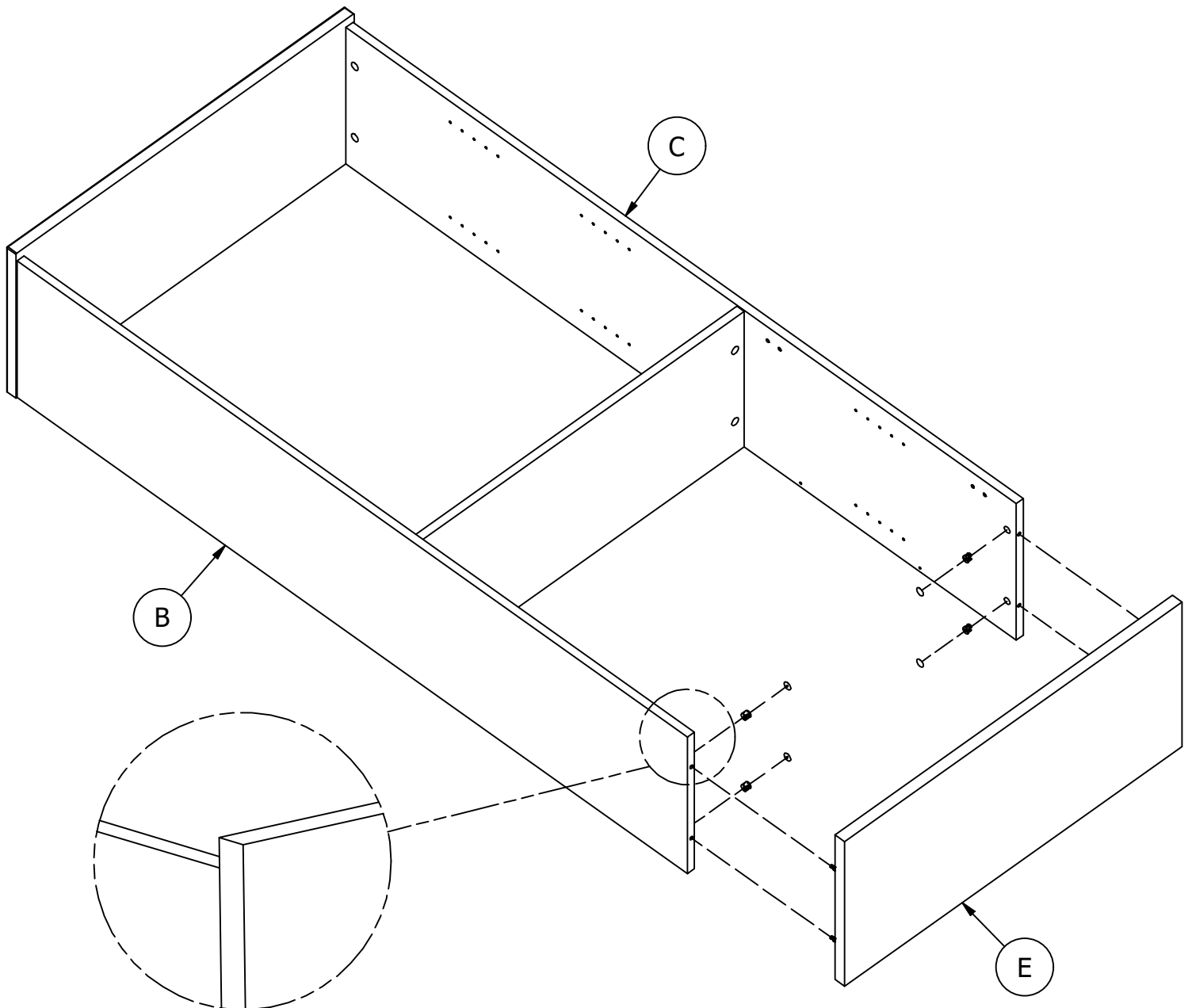
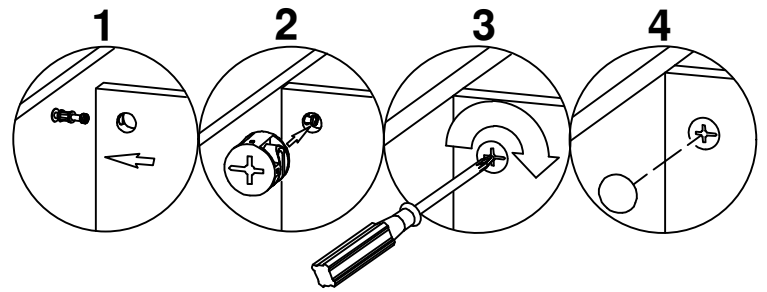

Have an assembly question or need a replacement part? Just call **1-800-950-4782**, we are here to help.

Team Lift

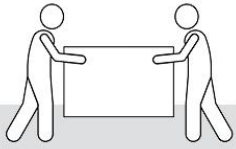

H34174

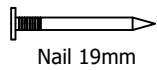

[49]

Nail 19mm

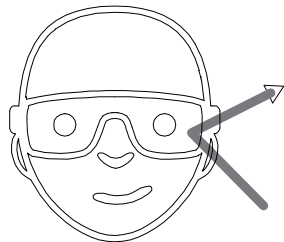

Safety glasses
Gafas de seguridad
Lunettes de protection

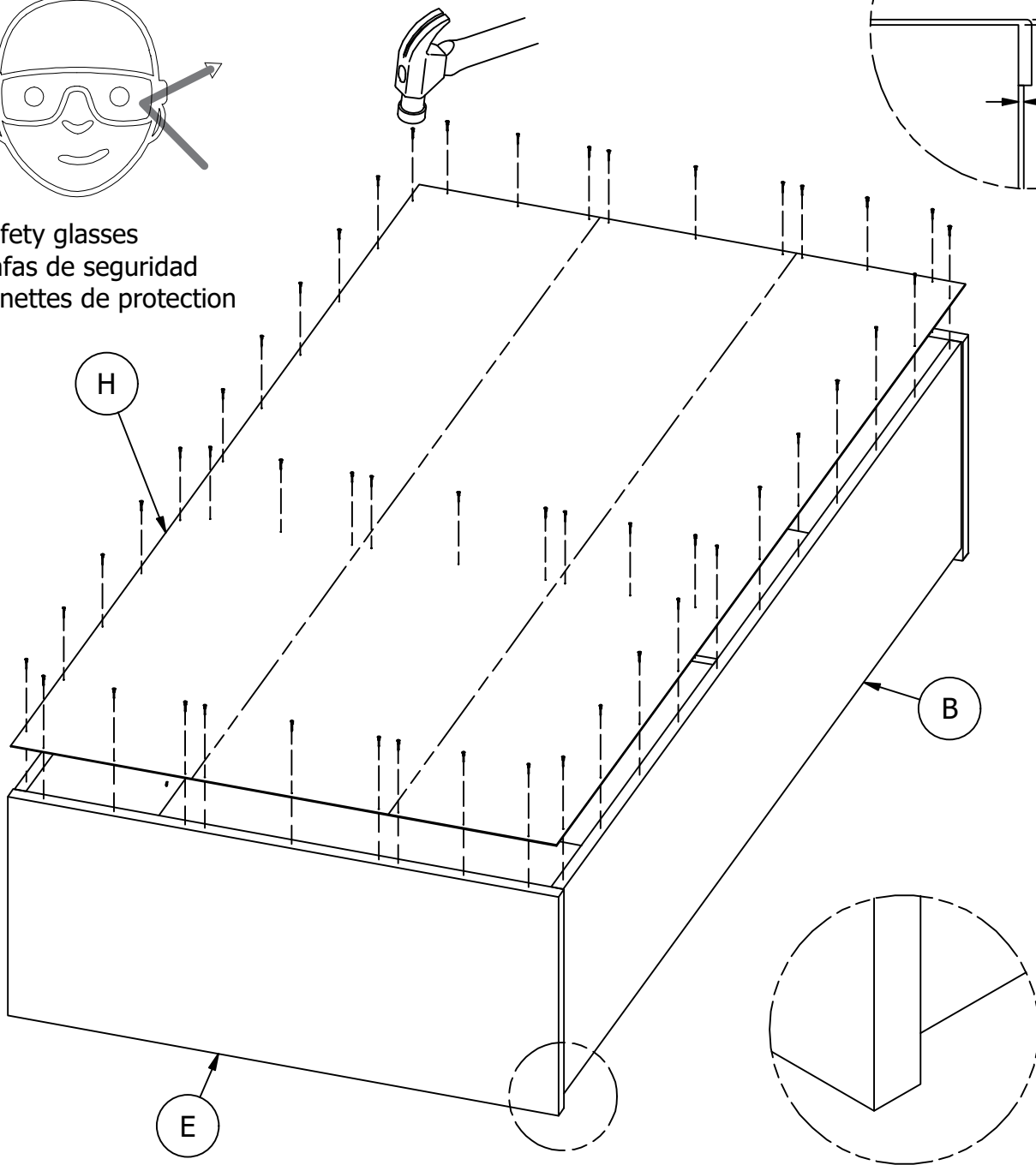
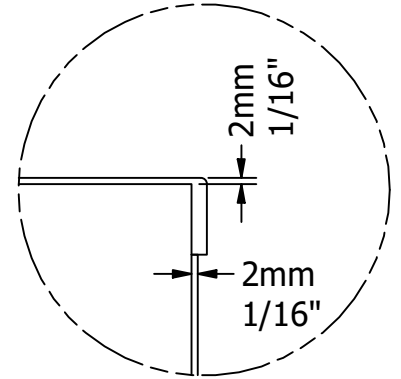

Have an assembly question or need a replacement part? Just call
1-800-950-4782, we are here to help.

Secure unit to the wall with a tip-over restraint.

Unidad de seguro a la pared con un sistema de retención de un vuelco.

Fixer l'unité au mur avec un dispositif de retenue renversement.

1. Place unit in desired location.
2. Locate wall stud nearest unit center. **FIG A**
3. On wall, mark center of stud location 1" below top of unit. **FIG A**
4. If a wall stud cannot be located mark hollow wall at unit center. **FIG A**
5. On back of unit, mark corresponding location 3/8" below top of unit. **FIG B**

1. Coloque la unidad en el lugar deseado.
2. Localice pie derecho de pared centro de unidad más próxima.
3. En la pared del, marque el centro de la ubicación del montante 1 "abajo la parte superior de la unidad.
4. Si un poste de la pared no se puede localizar marcar pared hueca en el centro de la unidad.
5. En el dorso de la unidad, marque la ubicación 3/8 correspondiente abajo la parte superior de la unidad.

1. Placez l'unité à l'endroit désiré.
2. Localiser centre d'unité la plus proche de la paroi Stud.
3. Sur le mur, centre de emplacement du montant 1 "ci-dessous dessus de l'appareil de la marque.
4. Si un montant de mur ne peut pas être situé marquer mur creux au centre de l'unité.
5. Le dos de l'appareil, marquer l'emplacement 3/8 correspondant ci-dessous dessus de l'appareil.

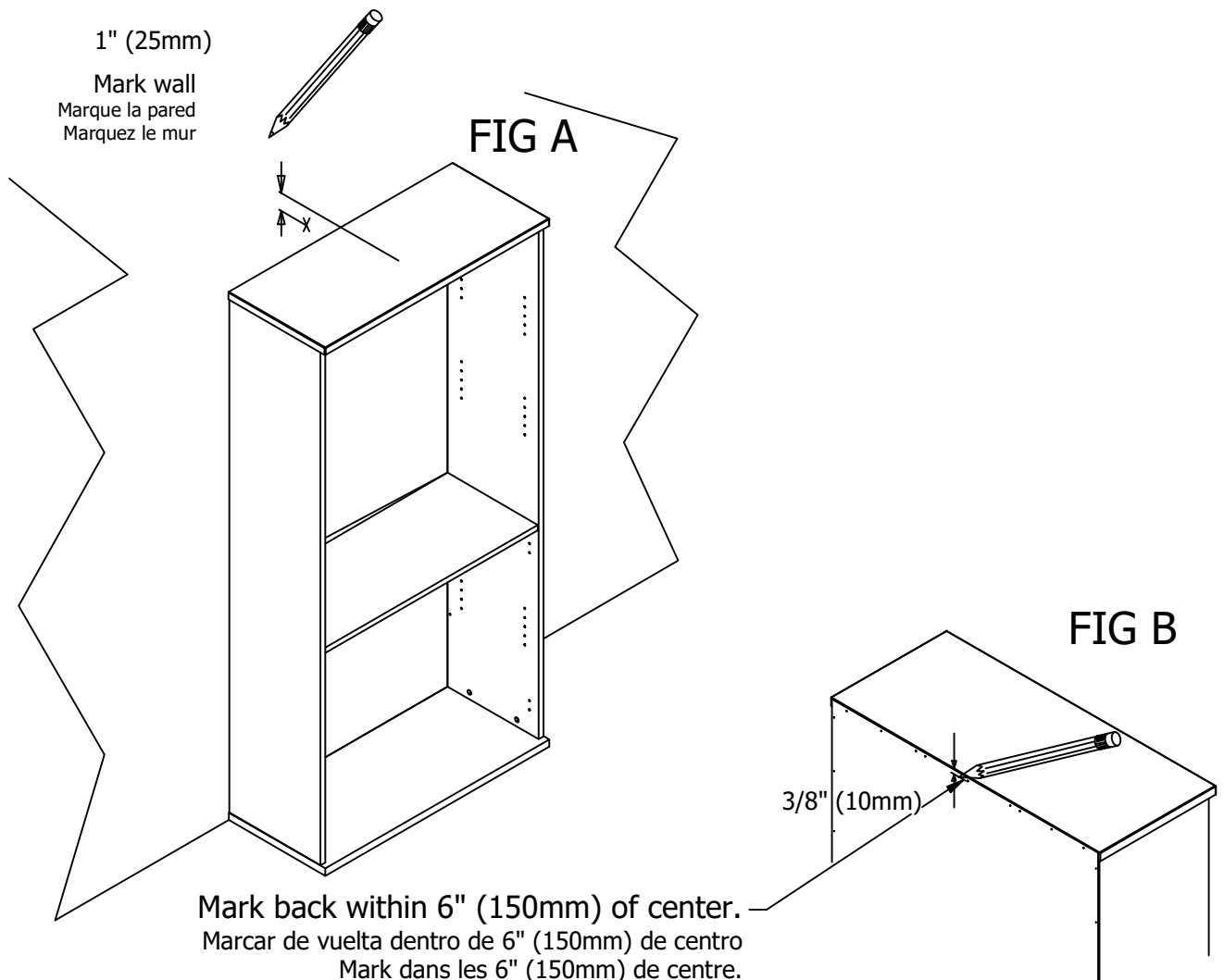

Have an assembly question or need a replacement part? Just call
1-800-950-4782, we are here to help.

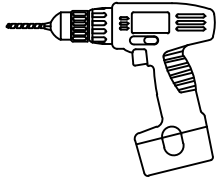

WALL STUD ATTACHMENT

Drill 1/8" hole 2" deep at mark on wall.
 Taladro 1/8 "agujero 2" de profundidad en la marca en la pared.
 Percer 1/8 "trou de 2" de profondeur à la marque sur le mur.

H181434

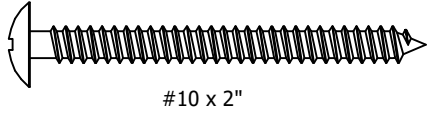

[1]

H181412

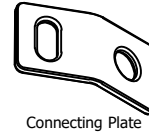

[1]

H181412

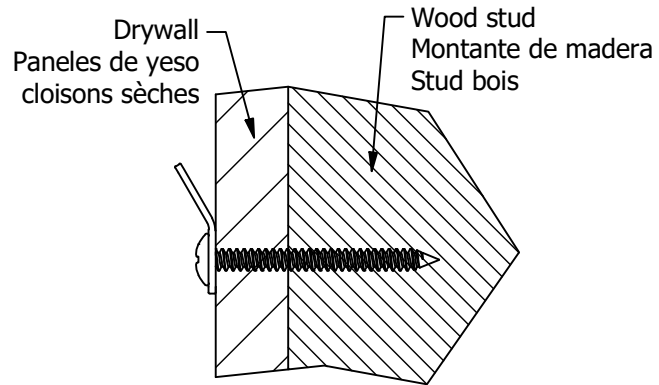
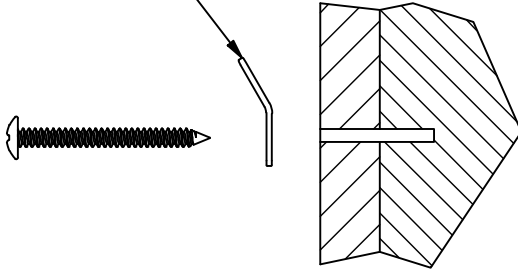

HOLLOW WALL ATTACHMENT

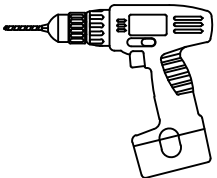

Drill 1/2" hole 1" deep at mark on wall.
 Taladro 1/2 "agujero 1" de profundidad en la marca en la pared.
 Percer 1/2 "trou de 1" de profondeur à la marque sur le mur.

H181419

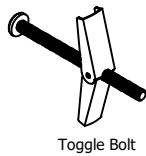

[1]

H181412

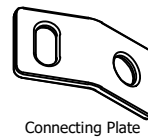

[1]

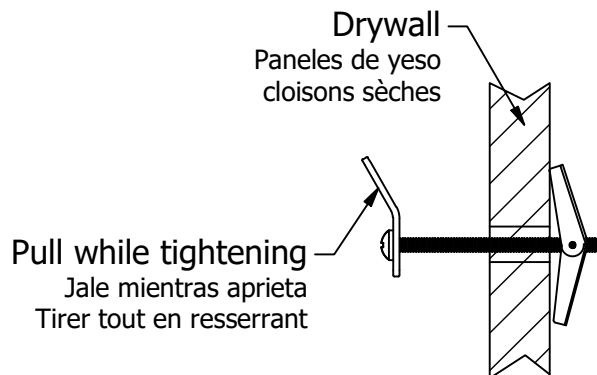
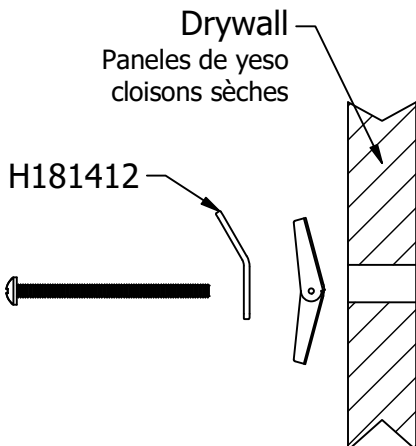

Have an assembly question or need a replacement part? Just call
1-800-950-4782, we are here to help.

H107572

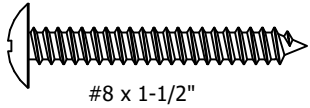

[1]

#8 x 1-1/2"

H181412



[1]

Connecting Plate

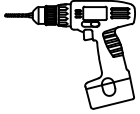

Drill 1/8" hole 1" deep at mark on unit.

Taladro 1/8 "agujero de 1" de profundidad en la marca de la unidad.

Perçer 1/8 "trou 1" de profondeur à la marque sur l'unité.

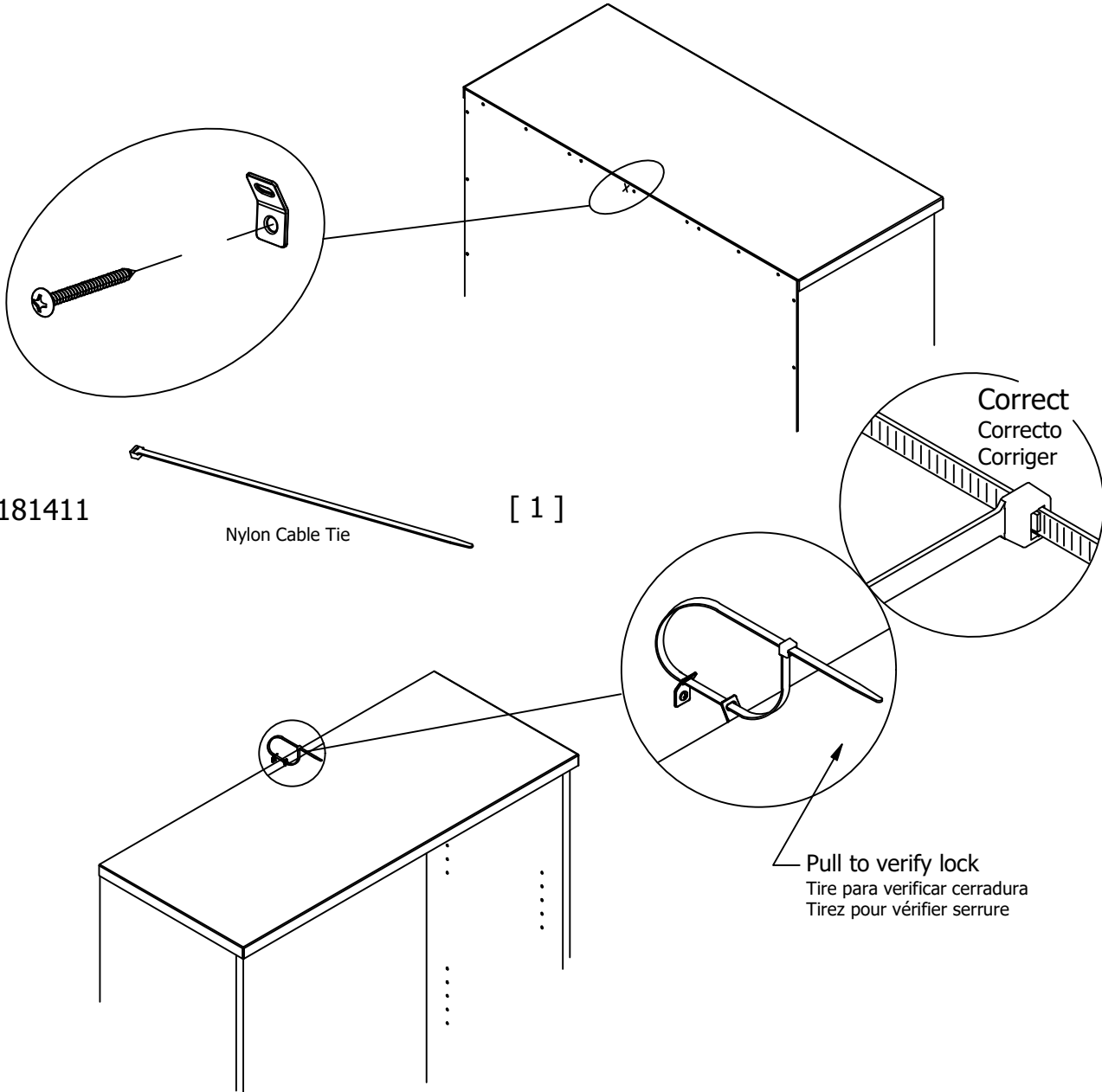

H181411

Nylon Cable Tie

[1]

Use replacement cable tie with minimum breaking strength of 120lbs.

Utilice reemplazo empate Cable con resistencia a la rotura mínima de 120 libras.

Utilisez remplacement Attache de câble avec une force de rupture minimale de 120 lbs.

Have an assembly question or need a replacement part? Just call

1-800-950-4782, we are here to help.

STEP 11

Maximum Loading and Cleaning

A173226H

Scan QR Code to Watch Video on:



How to Clean the Surface

H23604

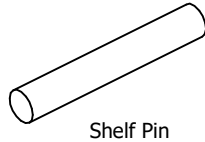

[12]

Shelf Pin

H126396

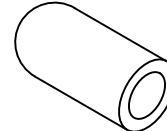

[12]

Shelf Pin Sleeve

Gently clean surfaces with a damp sponge eraser.

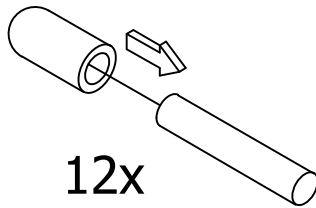

12x

Maximum Weight: 50 Lbs.
Peso Máximo: 50 Libras
Poids Maximum: 22.7 kilogramme

Maximum Weight: 0 Lbs.
Peso Máximo: 0 Libras
Poids Maximum: 0.0 kilogramme

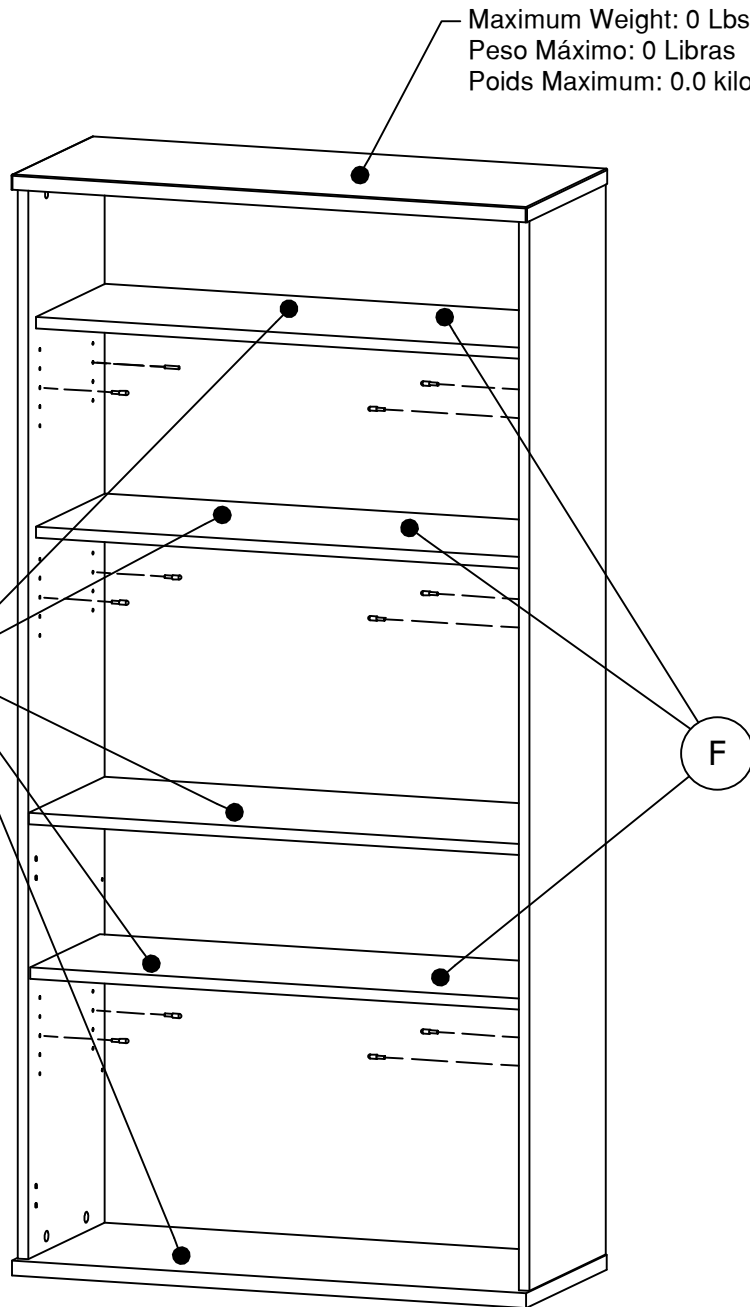

Congratulations! You are all done. If you have any questions or concerns, please call.

Have an assembly question or need a replacement part? Just call **1-800-950-4782**, we are here to help.

WC12914

- | | |
|-----------------|-----------------|
| A [1] W128019 | E [1] W145774 |
| B [1] W173211 | F [3] W166112 |
| C [1] W173212 | H [1] W145775 |
| D [1] W128020 | |

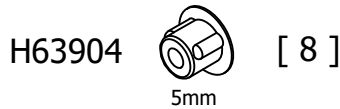
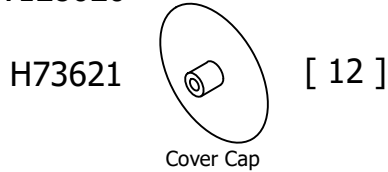

WC24414

- | | |
|-----------------|-----------------|
| A [1] W96095 | E [1] W145779 |
| B [1] W173213 | F [3] W166114 |
| C [1] W173214 | H [1] W145780 |
| D [1] W96098 | |

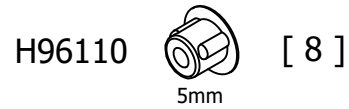
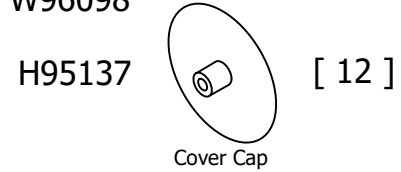

WC36714

- | | |
|-----------------|-----------------|
| A [1] W128026 | E [1] W145784 |
| B [1] W173215 | F [3] W166116 |
| C [1] W173216 | H [1] W145785 |
| D [1] W128027 | |

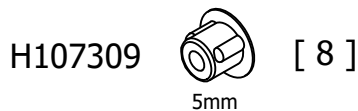
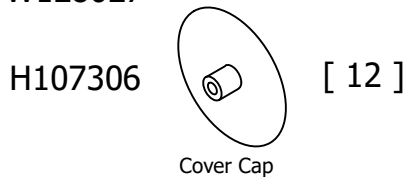

WC72414

- | | |
|-----------------|-----------------|
| A [1] W96976 | E [1] W145799 |
| B [1] W173223 | F [3] W166124 |
| C [1] W173224 | H [1] W145800 |
| D [1] W96977 | |

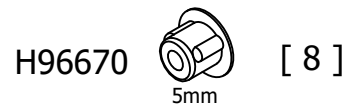
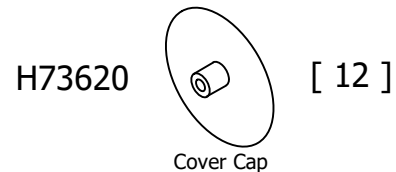

SCB136SG

- | | |
|-----------------|-----------------|
| A [1] W189339 | E [1] W191935 |
| B [1] W189343 | F [3] W189342 |
| C [1] W189344 | H [1] W184422 |
| D [1] W189340 | |

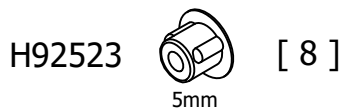
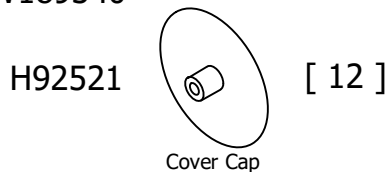

SCB136PG

- | | |
|-----------------|-----------------|
| A [1] W191688 | E [1] W191692 |
| B [1] W191689 | F [3] W191693 |
| C [1] W191690 | H [1] W191694 |
| D [1] W191691 | |

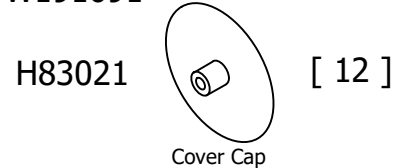

SCB136BW

- | | |
|-----------------|-----------------|
| A [1] W205549 | E [1] W205554 |
| B [1] W205552 | F [3] W205551 |
| C [1] W205553 | H [1] W205548 |
| D [1] W205550 | |

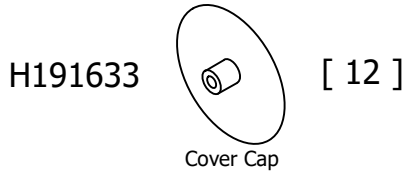

SCB136MH

- | | |
|-----------------|-----------------|
| A [1] W205556 | E [1] W205561 |
| B [1] W205559 | F [3] W205558 |
| C [1] W205560 | H [1] W205555 |
| D [1] W205557 | |

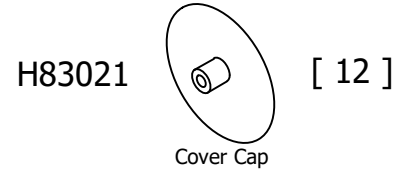

SCB136NE

- | | |
|-----------------|-----------------|
| A [1] W216028 | E [1] W216032 |
| B [1] W216029 | F [3] W216033 |
| C [1] W216030 | H [1] W216034 |
| D [1] W216031 | |

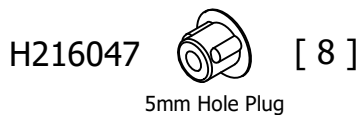

SCB136WH

- | | |
|-----------------|-----------------|
| A [1] W191946 | E [1] W191950 |
| B [1] W191947 | F [3] W191951 |
| C [1] W191948 | H [1] W184376 |
| D [1] W191949 | |

