

PARTS LIST / LISTE DES PIÈCES / LISTA DE PIEZAS

ITEM NO. / NO D'ARTICLE / ARTICULO NO. : P361-270

DESCRIPTION / LA DESCRIPTION / DESCRIPCIÓN : UPH SIDE CHAIR / CHAISE D'APPOINT CAPITONNÉ / SILLA TAPIZADA

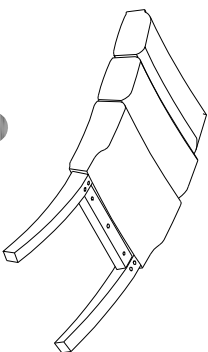
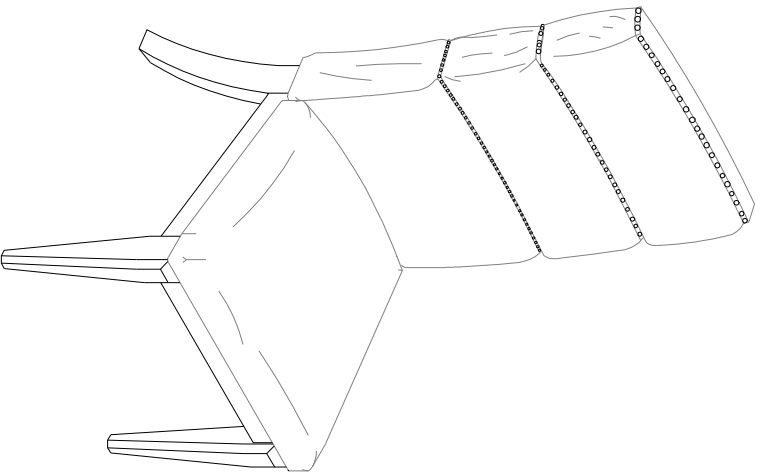

- A**
- x1 Chair back *
 - x1 Dossier de chaise
 - x1 Respaldo de la silla

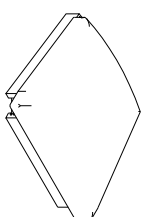

- B**
- x1 Seat Cushions *
 - x1 Coussins de siège
 - x1 Colchines de asientos

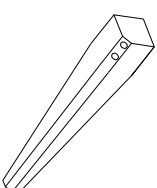

- C**
- x2 Left/Right front leg *
 - x2 Gauche/Bras patte avant
 - x2 Izquierda/Brazo pata delantera

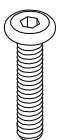

- D**
- x1 Allen bolt $\phi 1/4" \times 47mm$ *
 - x1 Vis à tête creuse hexagonale $\phi 1/4" \times 47mm$
 - x1 Perno Allen $\phi 1/4" \times 47mm$



- E**
- x1 Flat Washer $\phi 1/4" \times 19 \times 2mm$ *
 - x1 Rondelle plate $\phi 1/4" \times 19 \times 2mm$
 - x1 Arandela plana $\phi 1/4" \times 19 \times 2mm$



- F**
- x1 Lock washer $\phi 1/4"$ *
 - x1 Rondelle de blocage $\phi 1/4"$
 - x1 Arandela de Seguridad $\phi 1/4"$

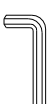

- G**
- x1 Allen Key 4mm *
 - x1 Clé hexagonale 4mm
 - x1 Llave Allen 4mm

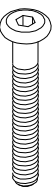

- H**
- x4 Allen bolt $\phi 5/16" \times 64mm$ *
 - x4 Vis à tête creuse hexagonale $\phi 5/16" \times 64mm$
 - x4 Perno Allen $\phi 5/16" \times 64mm$

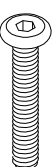

- I**
- x4 Allen bolt $\phi 5/16" \times 50mm$ *
 - x4 Vis à tête creuse hexagonale $\phi 5/16" \times 50mm$
 - x4 Perno Allen $\phi 5/16" \times 50mm$



- K**
- x8 Lock washer $\phi 5/16"$ *
 - x8 Rondelle de blocage $\phi 5/16"$
 - x8 Arandela de Seguridad $\phi 5/16"$



- L**
- x1 Allen Key 5mm *
 - x1 Clé hexagonale 5mm
 - x1 Llave Allen 5mm



- J**
- x8 Flat Washer $\phi 5/16" \times 19 \times 2mm$ *
 - x8 Rondelle plate $\phi 5/16" \times 19 \times 2mm$
 - x8 Arandela plana $\phi 5/16" \times 19 \times 2mm$

* Replaceable Part

Residential Use Only

ASSEMBLY INSTRUCTIONS/ NOTICE DE MONTAGE/ INSTRUCCIONES DE MONTAJE

ITEM NO./ NO D'ARTICLE/ ARTICULO NO. : P361-270

DESCRIPTION/ LA DESCRIPTION / DESCRIPCIÓN : UPH SIDE CHAIR / CHAISE D'APPOINT CAPTONNÉ / SILLA TAPIZADA

STEP 1 ÉTAPE 1 PASO 1

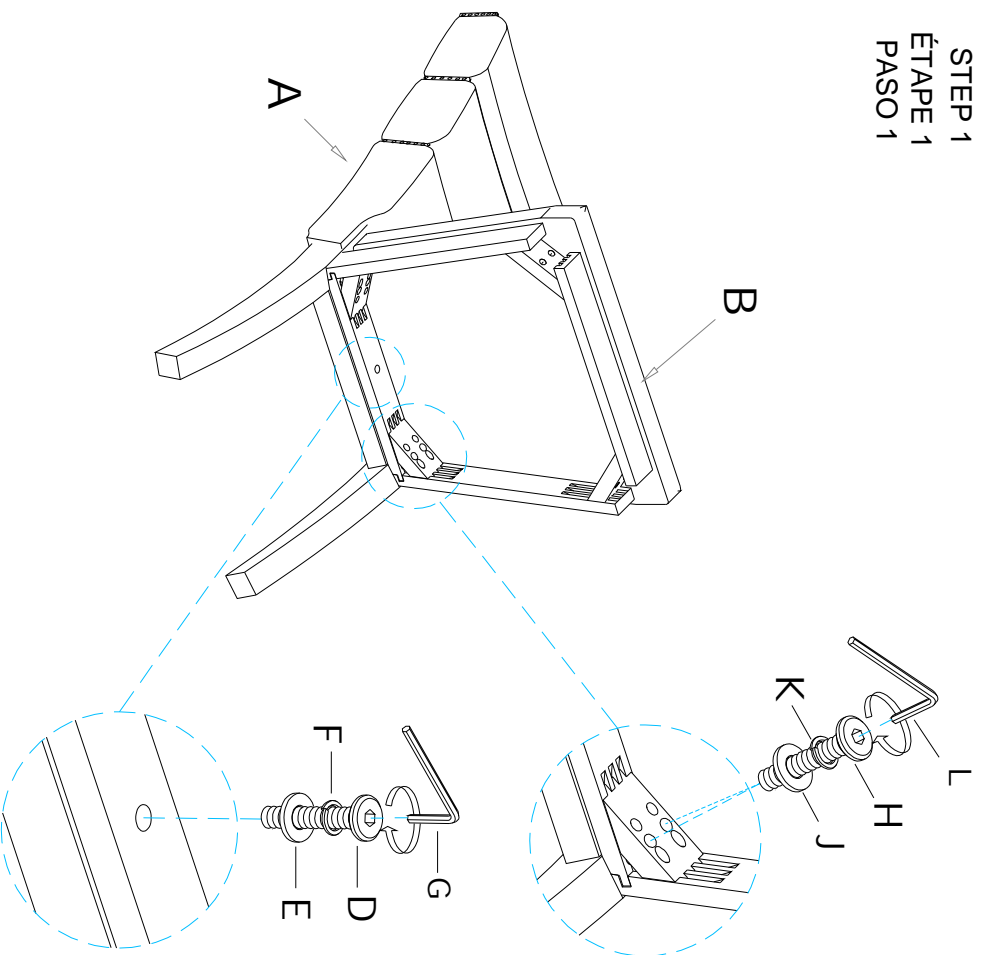

STEP 2 ÉTAPE 2 PASO 2

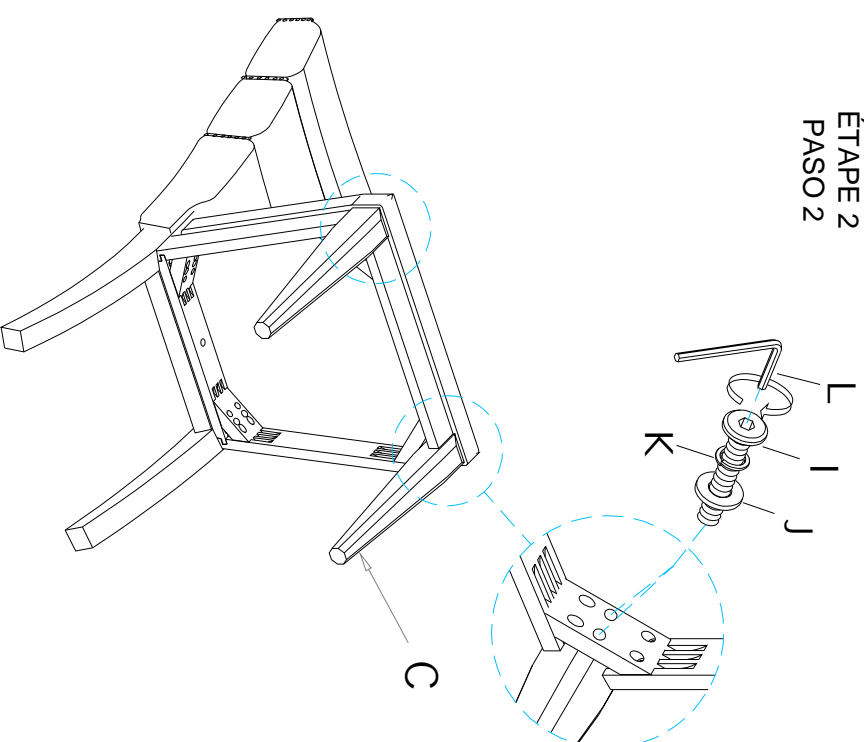

* Replaceable Part

REPLACEABLE PART / PARTIE REMPLAÇABLE / PARTE REEMPLAZABLE

ITEM NO./ NO D'ARTICLE/ARTICULO NO. : P361-270
 DESCRIPTION/ LA DESCRIPTION/ DESCRIPCIÓN : UPH SIDE CHAIR / CHAISE D'APPOINT CAPTONNÉ / SILLA TAPIZADA

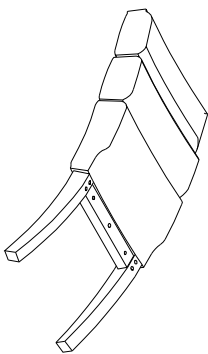
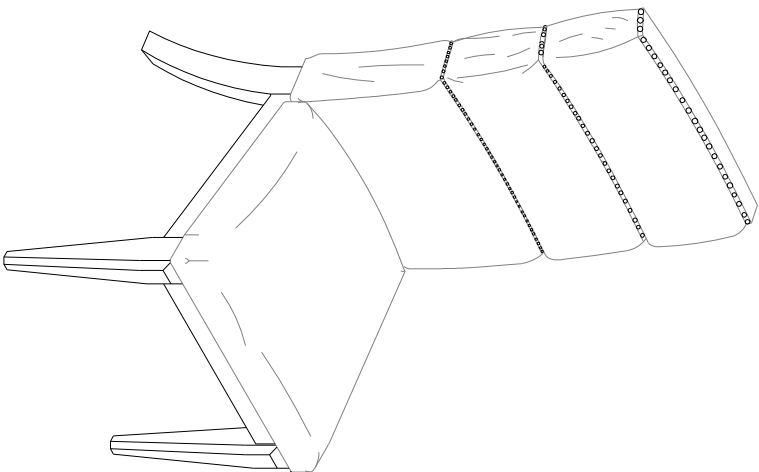

x1 RP361-270-BACK- Chair Back
 Dossier de chaise
 Pespado de silla *

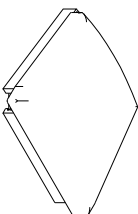

x1 RP361-270-FRAME- Seat frame with cushion
 Siège avec coussin
 Cojin de asiento con cuadro del asiento *



x1 RP361270-LEGL- Front leg (Left) *

Patte avant (Gauche)
 Pata delantera (Izquierda)

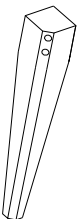

x1 RP361270-LEGR-Front leg (Right) *

Pate avant (Arrière)
 Pata delantera (Derecha)



x1 RP361270-HWKIT-Hardware
 Liste des pièces de quincaillerie
 Lista del kit de materiales *

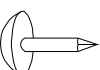

x4 RC-WH-NAIL - White Plastic Nail
 Clou en plastique
 Clavo de plástico

* Replaceable Part

Residential Use Only

Protect Your Wood or Laminate Flooring

* This statement applies to any floor without carpet.

If not careful, all furniture including upholstery and case pieces can scratch, scuff and even gouge floors. The recommendation is to have felt, rubber pads or area rugs under furniture on flooring without carpet.

Moving your furniture

Pushing and dragging furniture over floor without carpet can lead to scratches and scuffs. Have someone help when moving the larger pieces of furniture by lifting, try using a dolly or moving pads.

Felt and rubber pads

Applying furniture pads to the feet of furniture helps cushion contact points. Furniture pads can be found at local hardware stores. Felt pads slide easily across the floor, making them ideal for dining chairs and other pieces that move with use. Rubber pads will help furniture stay in place and are perfect for larger pieces, like sofas and loveseats.

Area rugs and rug pads

Using an are rug under furniture is another way to protect your floor from scratches and scuff marks. A rug pad under the area rug will provide extra cushion and added protection.

* *Replaceable Part*