

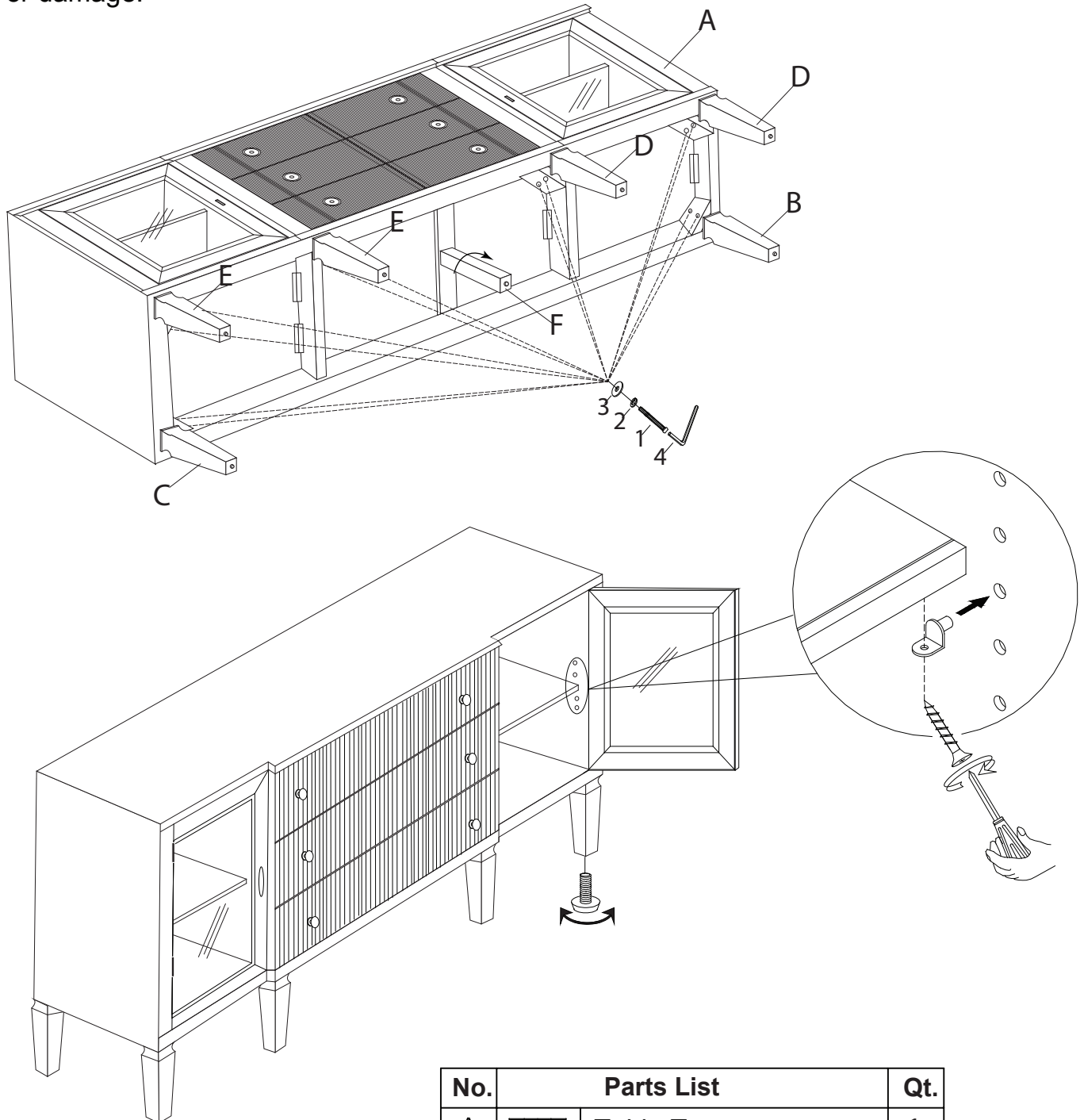







Thank you for purchasing this quality product from A.R.T. Furniture. Be sure to check all packing material for parts which may have come loose inside the carton during shipment. Identify and count all parts and compare with the parts list below.

**Note:** Some furniture is heavy, it is recommended that two people assembly this item to avoid injury or damage.



No.	Hardware List	Qt.
1	 $\frac{5}{16}$ " x 2" Bolt	12
2	 $\frac{5}{16}$ " Lock Washer	12
3	 $\frac{5}{16}$ " Flat Washer	12
4	 M5 Allen	1

No.	Parts List	Qt.
A	 Table Top	1
B	 Back leg Left	1
C	 Back leg Right	1
D	 Font leg Left	2
E	 Font leg Right	2
F	 Support legs	1