

# ASSEMBLY INSTRUCTION













ITEM# 5070-90267 6/6 PANEL HEADBOARD

5070-90268 6/6 Panel Footboard (C)

5070-90269 6/6 Panel Rails (C)

5070-90263 6/0 Panel Rails (C)

**Caution: Please make sure you have all parts indicated below prior to assembly.**  
**This unit is heavy and can best be assembled with the help of two or more persons.**

NO.	HARDWARE LIST		Q'TY
E		NUT	8
F		SPANNER WRENCH	8
G		CURVED WASHER	8
H		FULL THREADED BOLT	8
K		SCREW	20
R		4MM ALLEN WRENCH	1
Q		1/4" * 35MM BOLT	10
V		1/4" LOCK WASHER	10
U		1/4" FLAT WASHER	10
M		5MM ALLEN WRENCH	1
N		5/16" * 40MM BOLT	9
O		5/16" LOCK WASHER	9
P		5/16" FLAT WASHER	9

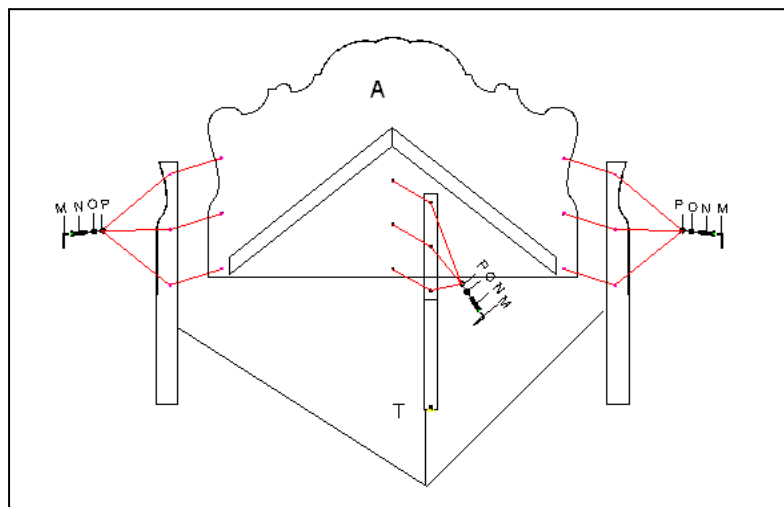
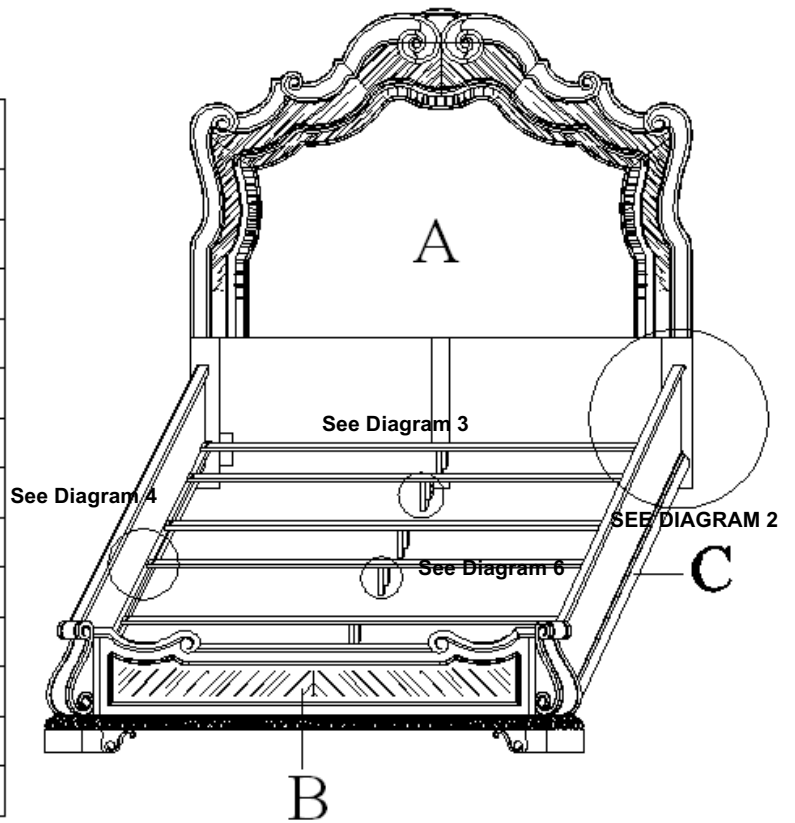

**DIAGRAM 1**

There are 2 hardware bags.

One is to assemble K/D posts to HB panel which is attached at the back of HB.

One is to assemble side rails to HB&FB which is in the box of side rails.

Please note.

### Assembly steps:

1. Attach two side posts (T) to each side of the back of the headboard (A) using bolts (N), lock washers (O) and flat washers (P). Secure bolts (N) by allen wrench (M) as shown in diagram 1. Then attach the middle post (T) to the center of headboard (A) in the same way. (See Diagram 1)

2. Insert 2 bolts (H) into holes of each side post on Headboard (A) and on Footboard (B), attach the end of side rails (C) to bolts (H) on posts using 2 curved washers (G) and 2 nuts (E), tighten nuts (E) securely with the spanner wrench (F). (See diagram 2)

Note: Please make sure the end of side rail with a rail must be placed on top when assembling 6/0 panel rails. (see diagram 7)

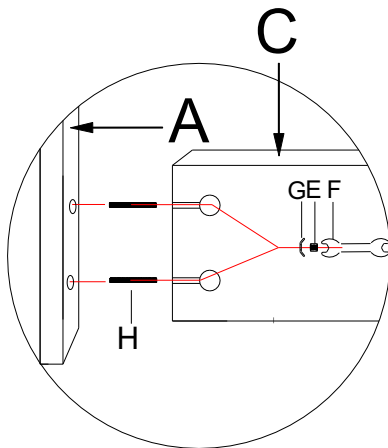

Diagram 2

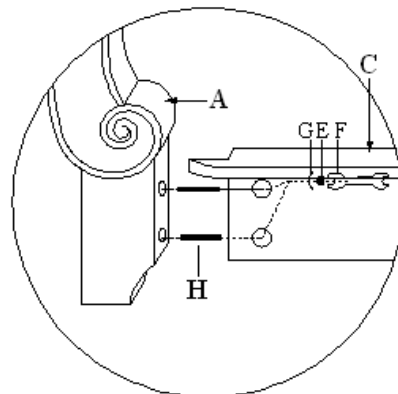
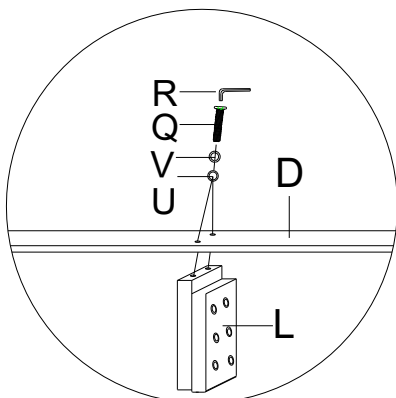

Diagram 7

3. Take out the center supports (L) from the rail box, attach center supports (L) to slats (D) using 2 bolts (Q), 2 lock washers (V) and 2 flat washers (U). Secure bolts (Q) by using allen wrench (R). (See diagram 3)



### Diagram 3

4. Attach slats (D) to side rails (C), align pre-drilled holes on the slat to holes on the cleat of side rail (C), using screws (K) to tighten both. (See diagram 4)

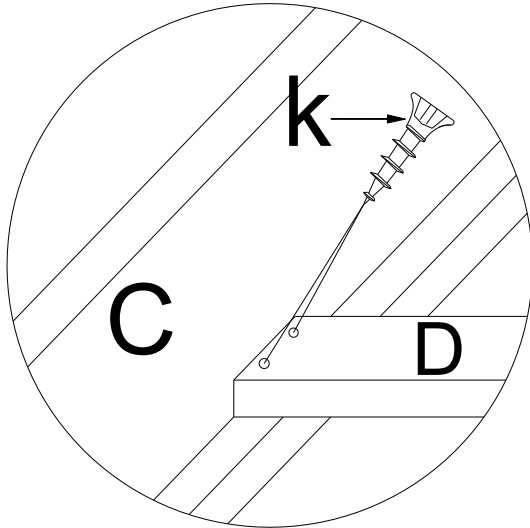

### Diagram 4

Note: You can change the height of slat by adjusting the height of cleat on side rails as shown in diagram 5, remove bolt (I), lock washer (W) and flat washer (J) from the cleat by turning the bolt (I) with allen wrench (M) in anti-clockwise direction, adjust the cleat to a desired position, and then secure lock washer, flat washer, bolt in a clockwise direction by turning with allen wrench (M).

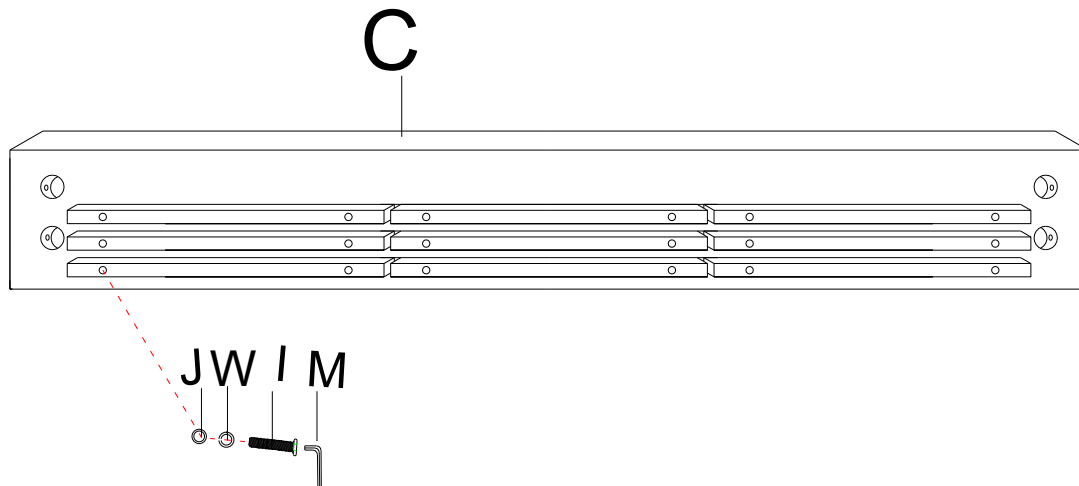

### Diagram 5

You can adjust the height of center supports (L) as shown in Diagram 6 to meet your need by the following steps.

1. Unscrew bolts on center supports (L) with allen wrench (R).

- Adjust the height of center supports, align the holes on 2pcs of woods and tighten them together with 2 bolts(Q), 2 lock washers (V) and 2 flat washers (U) by turning with allen wrench(R) in a clockwise direction.

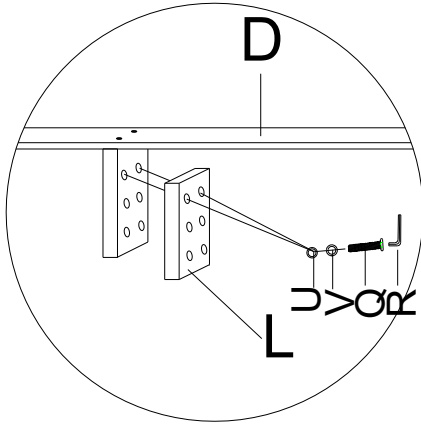

**Diagram 6**

***Cleaning Instruction: Clean finished parts with a mild dishwashing liquid and water solution on a damp cloth. Polish the finish with soft cloth and an industry recognized furniture polish.***