



Please read the following instructions and warnings before assembly and each use of the seat.

KEEP THIS INSTRUCTION MANUAL FOR FUTURE REFERENCE.

Tools required: Phillips screwdriver.
Requires one C (LR14) alkaline battery (not included) for vibration unit.

Keep small parts away from children.

For product support, contact us at 1-401-671-6551 or

www.summerinfant.com/contact

Use from birth until baby starts trying to sit up or has reached 20lbs (9kg) (whichever comes first).

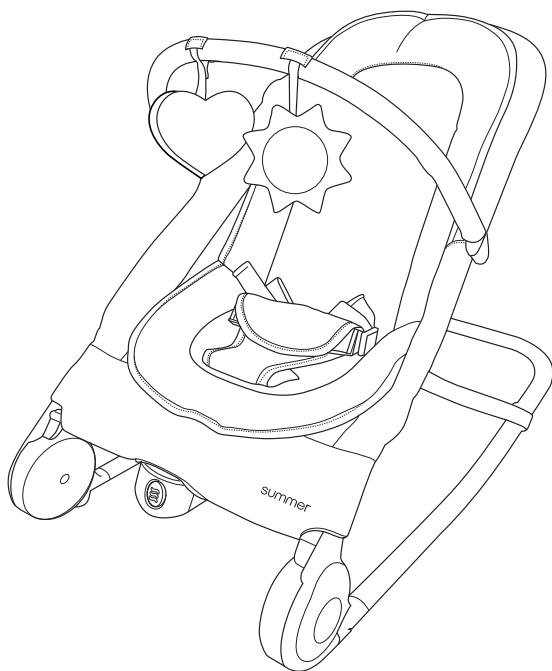

2-in-1 Bouncer & Rocker Duo™

INSTRUCTION MANUAL

WARNING

Read and follow all warnings and instructions before use of the product. Failure to do so could result in serious injury or death.

BOUNCER MODE:

FALL HAZARD: Babies have suffered skull fractures falling while in and from bouncers.

- Use bouncer **ONLY** on floor.
- **ALWAYS** use restraints and adjust to fit snugly.
- **NEVER** lift or carry baby in bouncer.

SUFFOCATION HAZARD: Babies have suffocated when bouncers tipped over on soft surfaces and/or when bouncers have been used as a sleep product.

- **NEVER** use on a bed, sofa, cushion, or other soft surface.
- Stay near and watch baby during use. This product is not safe for sleep or unsupervised use. If baby falls asleep, remove baby as soon as possible and place baby on a firm, flat sleep surface such as a crib or bassinet.

To prevent **falls** and **suffocation**:

- **ALWAYS** use restraints and adjust to fit snugly.
- **STOP** using bouncer when baby starts trying to sit up or has reached 20 lbs, whichever comes first.
- Do not use this product if it is damaged or broken.

ROCKER MODE:

- **FALL HAZARD:** Children have suffered head injuries falling from rockers.
- **ALWAYS** use restraints. Adjust to fit snugly.
- **NEVER** lift or carry baby in rocker.
- **STOP** using product when baby starts trying to sit up or has reached 20 lbs, whichever comes first.
- **ALWAYS** place rocker on floor. Never use on any elevated surface.
- **SUFFOCATION HAZARD:** Babies have suffocated when seats tipped over on soft surfaces.
- **NEVER** use on a bed, sofa, cushion, or other soft surface.
- Stay near and watch baby during use. This product is not safe for sleep or unsupervised use. If baby falls asleep, remove baby as soon as possible and place baby on a firm, flat sleep surface such as a crib or bassinet.
- **NEVER** leave baby unattended.
- The toybar is not a carry handle. **NEVER** use toybar to lift or carry product.
- **NEVER** adjust angle of product with child in seat.
- Never place child in product until frame is fully assembled and secured.

THIS PRODUCT SHOULD NOT REPLACE RESPONSIBLE ADULT SUPERVISION.

components:



IMPORTANT! Before assembly, inspect this product for damaged hardware, loose joints or missing parts. Never use if any parts are missing or broken.

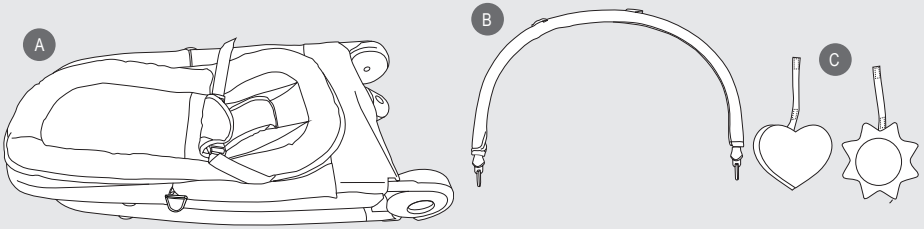

- A Bouncer
- B Toybar
- C Toys

features:

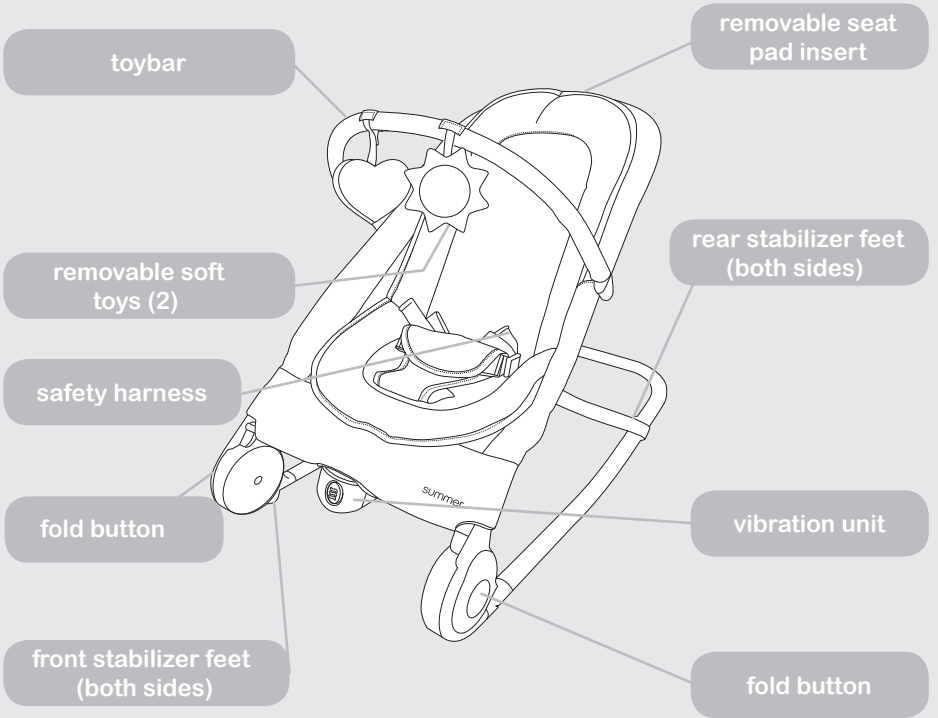

assembly instructions:

- 1 To unfold, press buttons on both sides of the frame, and raise seat up into one of 2 positions until it clicks into place.

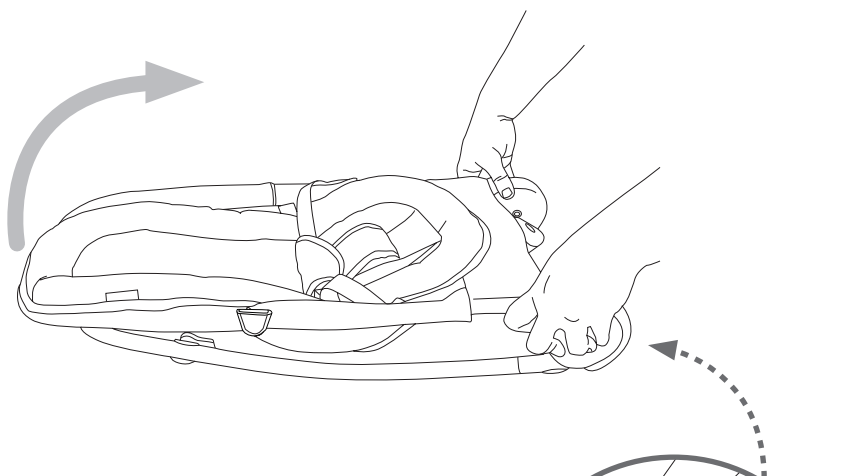

NEVER adjust angle of product with child in the seat.

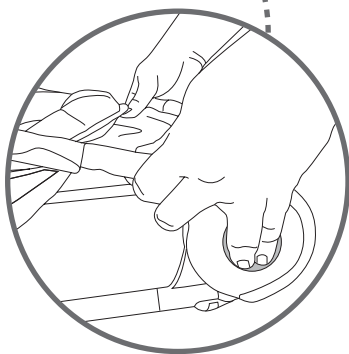

Position 1 - Rocker Mode

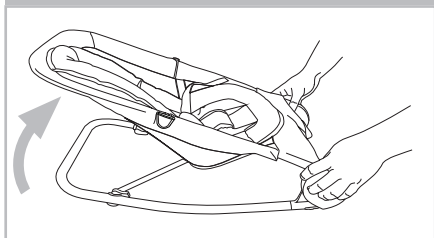

Position 2 - Bouncer Mode

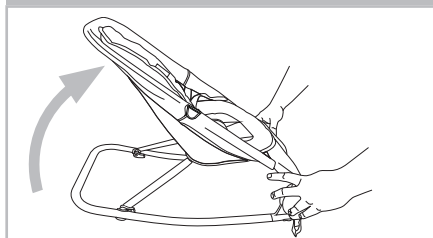

stabilizer feet position:

Position 1 - Rocker mode:

- 2** Rotate front and rear stabilizer feet in for rocker mode.

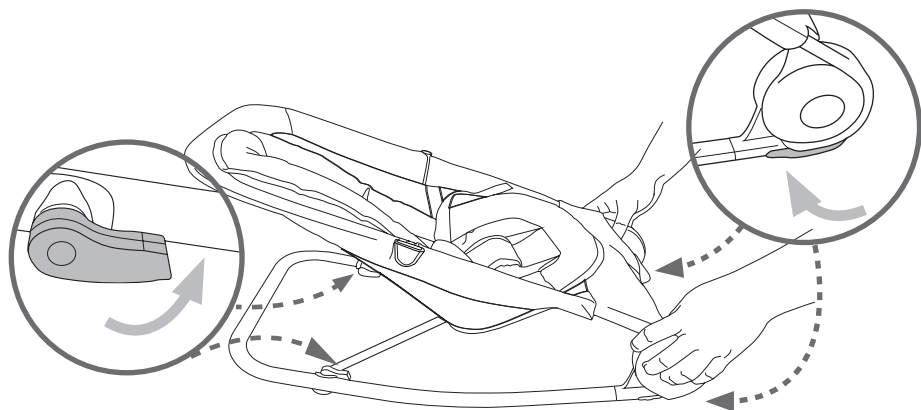

Position 2 - Bouncer mode:

- 3** Rotate front and rear stabilizer feet out for bouncer mode.

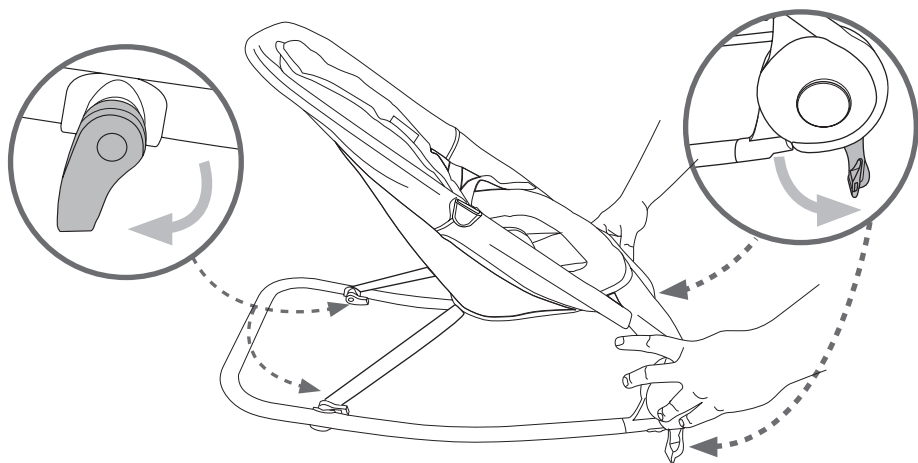

assembly instructions:

- 4** Align toybar with mounts on each side of the bouncer frame. Insert toybar until both sides click into place.

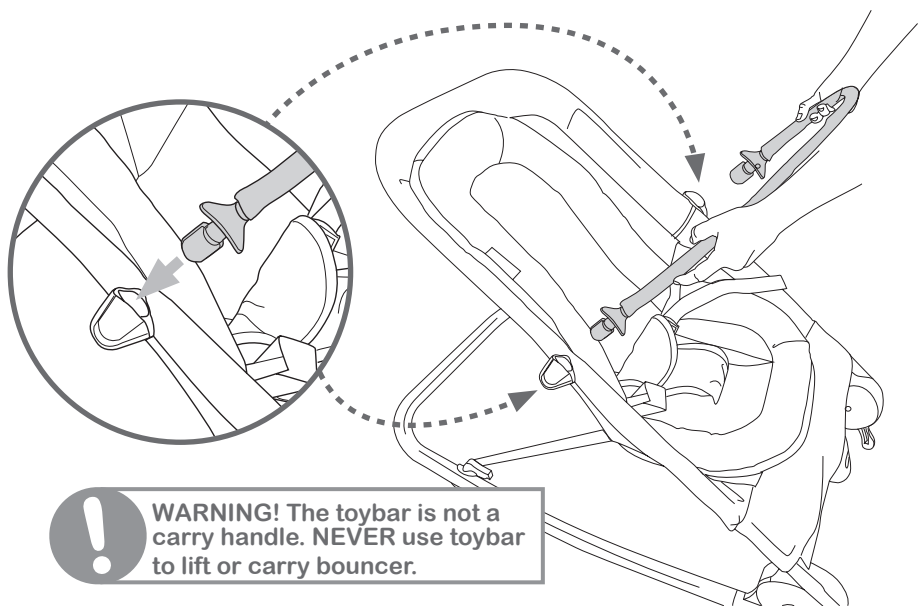

- 5** Thread straps on toys through the loops and fasten to toybar as shown.

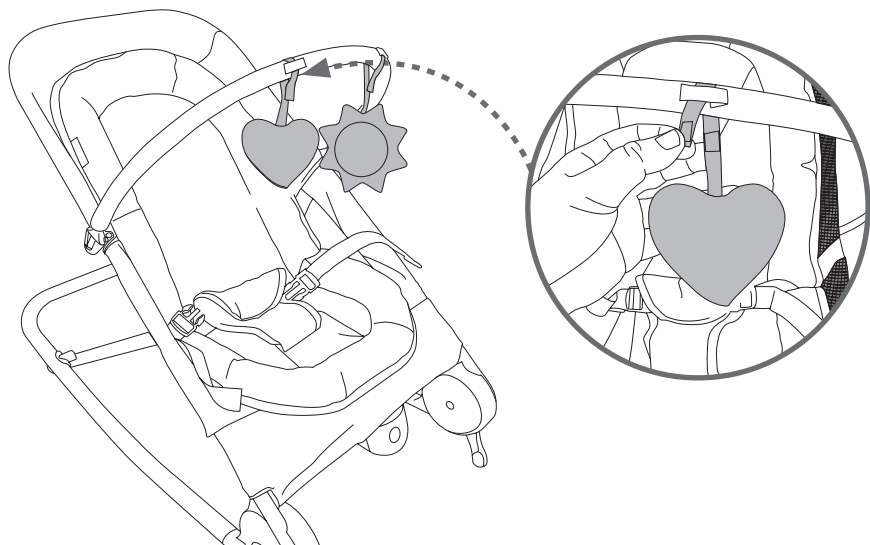

3-pt harness:

- 1 Secure infant in bouncer by adjusting the 3-pt harness to fit snugly around the infant's waist.

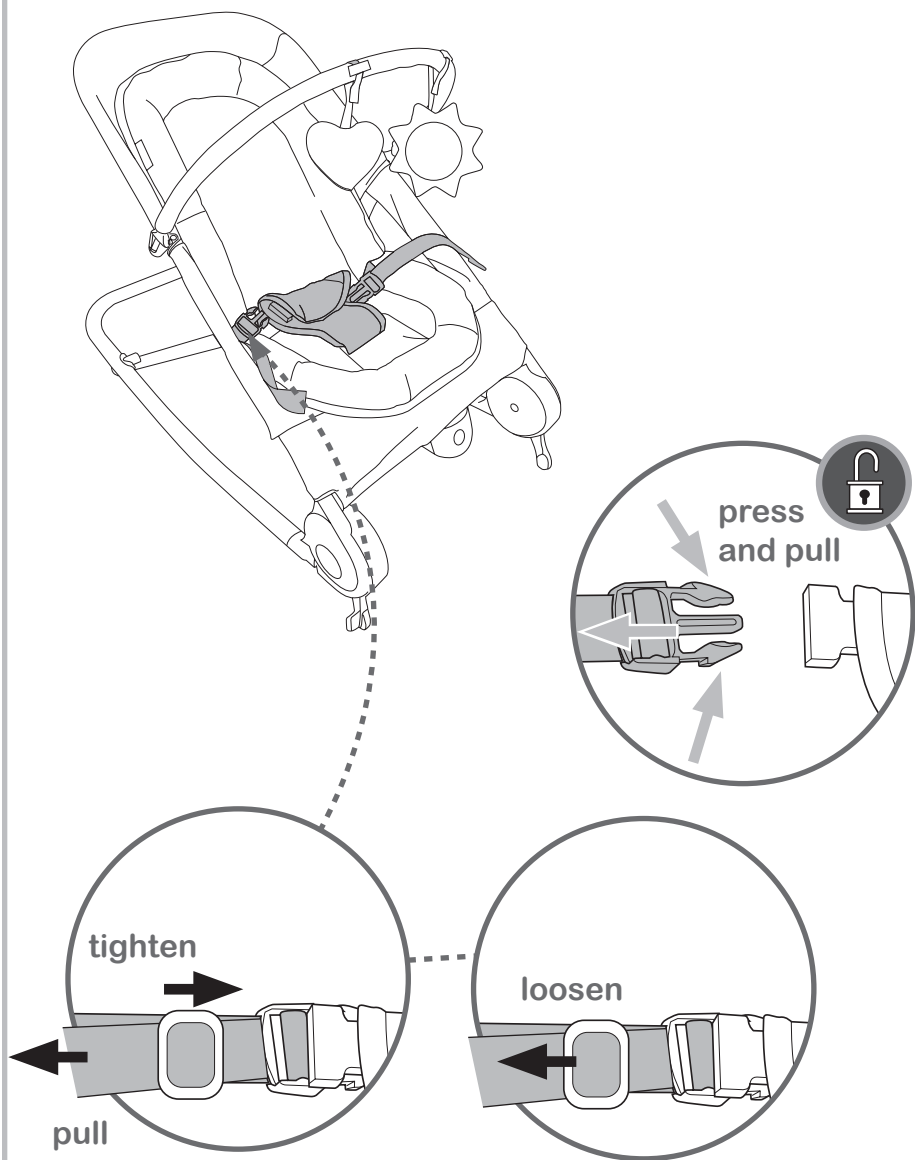

storing bouncer:

- 1 fold in stabilizer feet into rocker position.



Product should not be used in the storage position.

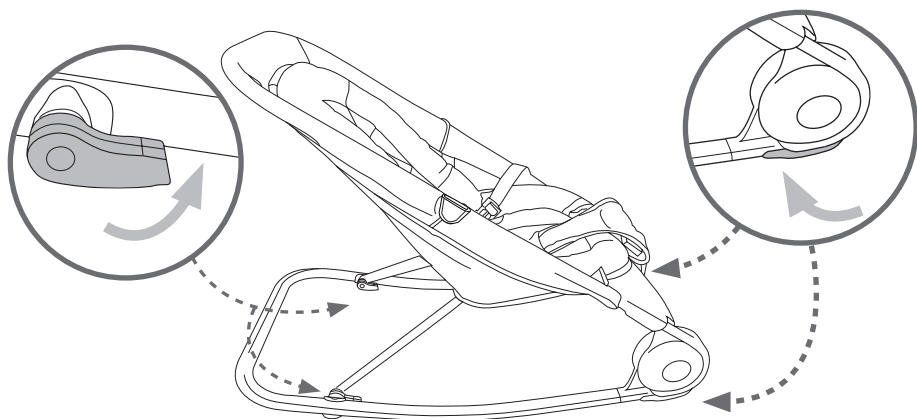

- 2 Remove toybar from frame.

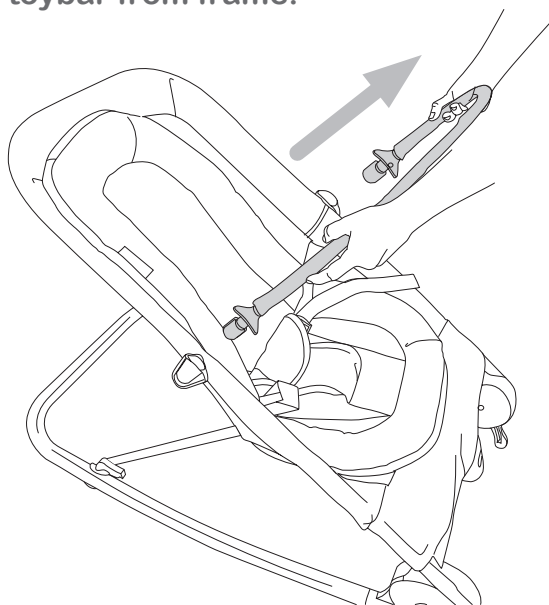

storing bouncer (cont.):

- 3 Press fold buttons on both sides of the frame, and lower seat into position until it clicks into place.

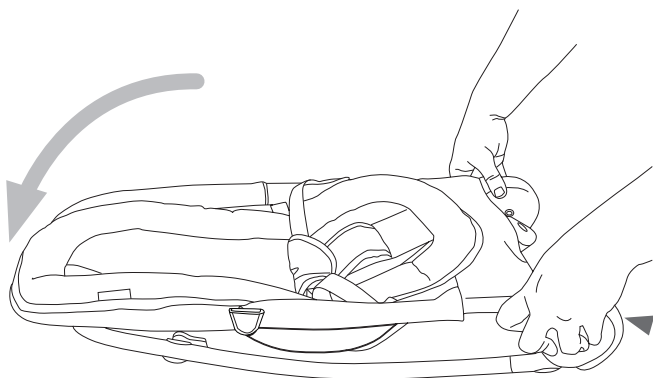

NEVER adjust angle of product with child in the seat.

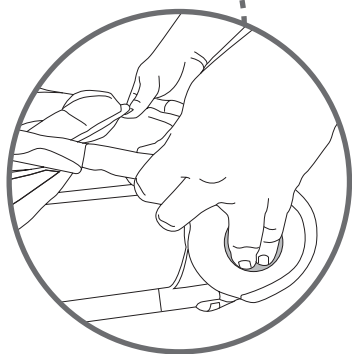

removing seat insert:

- 1 Unlock safety harness.

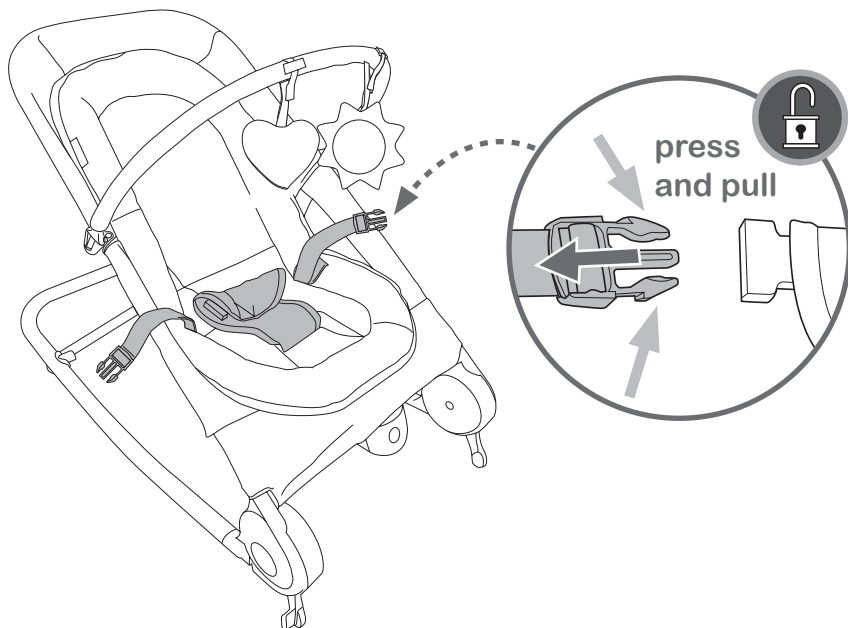

- 2 Remove toybar from frame.

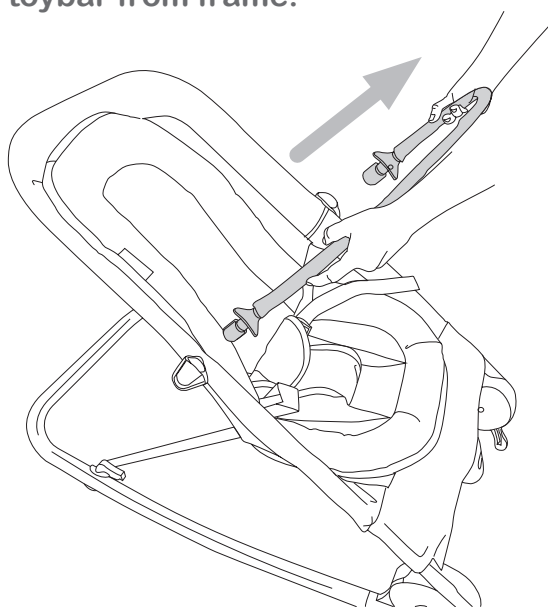

removing seat insert:

- 3 Slide crotch strap through the seat insert, then lift seat insert off the bouncer.

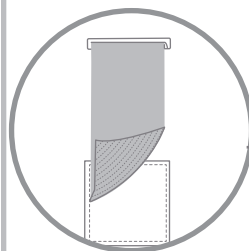

Remove insert from loop.

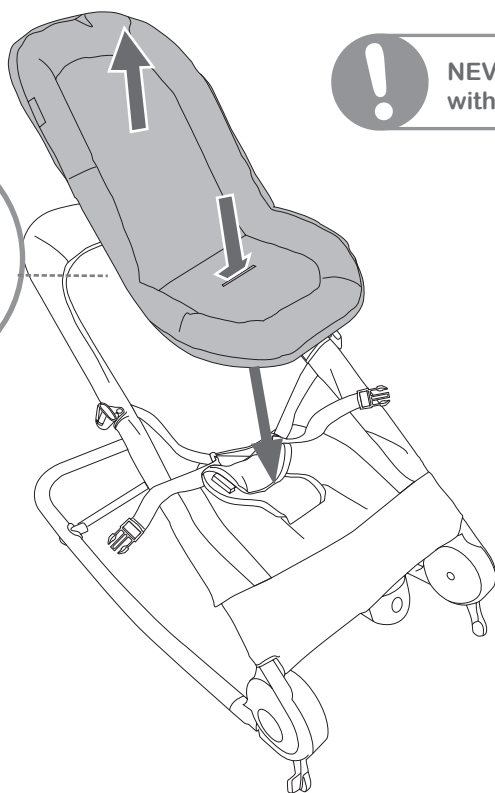

NEVER use product without the insert.

vibration unit:

- 1 Using a Philips screw driver, remove the cover of the battery compartment.

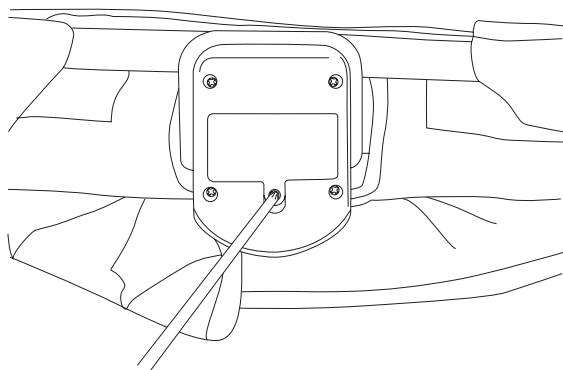

- 2 Insert 1 "C" (1.5V) battery into the battery compartment. Replace the door and secure with screw.

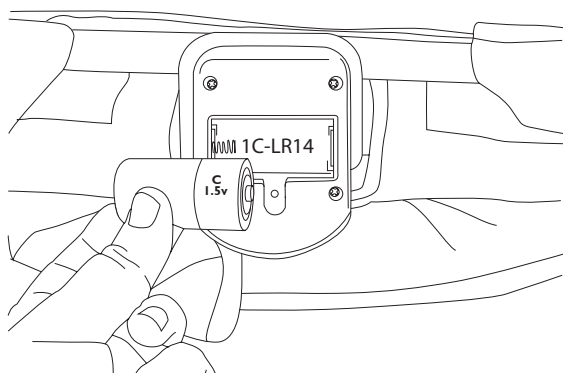

vibration unit (cont.):

- 1 To operate the vibration unit, press button to turn on, then press again to turn off.

NOTE: The vibration unit turns off after approximately 15 minutes.

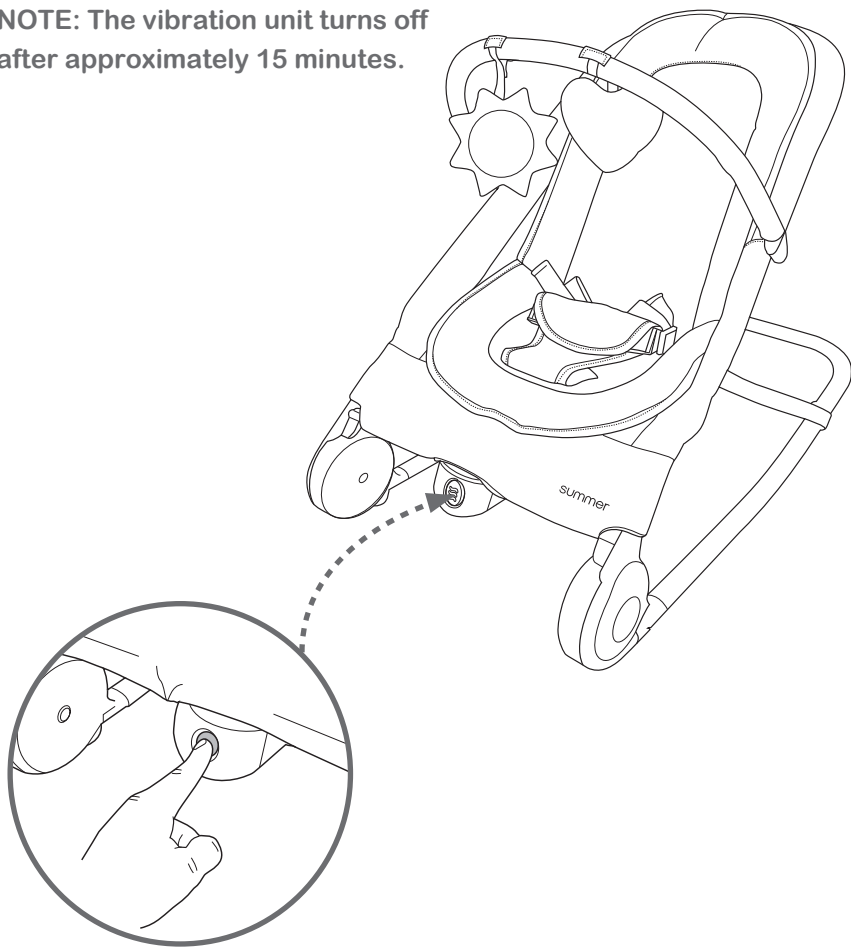

Battery Safety Information

FOR SAFE BATTERY USE:

- Keep batteries out of children's reach.
- Recommended type batteries—alkaline disposables, 1-C (LR14-1.5V). Change batteries when product ceases to operate satisfactorily.
- Do not mix old and new batteries.
- Do not mix alkaline, standard (carbon-zinc), or rechargeable (nickel-cadmium) batteries.
- Remove batteries when product is stored for long periods of time or when batteries are exhausted.
- Dispose of exhausted batteries properly.
- Non-rechargeable batteries are not to be recharged.
- Rechargeable batteries are to be removed from the toy before being charged.
- Rechargeable batteries are only to be charged under adult supervision.
- Batteries are to be inserted with the correct polarity.

CAUTION

To prevent battery leaks, which can burn skin and eyes:

- Remove the batteries when storing the product for a long time.
- Dispose of used batteries immediately.
- The supply terminals are not to be short-circuited.

Care and Maintenance

- Spot clean stains on fabric by hand washing with cold water and mild soap. Do not bleach. Air dry. Do not iron.
- Clean plastic and metal surfaces as well as toys with a soft damp cloth. Do not use abrasive cleaners or solvents.
- Removable fabric insert :
Machine wash in cold water, delicate cycle.
Do not bleach. Line dry. Do not iron.
Never use product without the insert.
- Inspect this product for damaged hardware, loose joints or missing parts. Never use if any parts are missing or broken.

Radio and Television Interference

Changes and Modifications not expressly approved by Summer Infant (USA), Inc. can void your authority to operate this equipment under Federal Communications Commission rules.

This device complies with part 15 of the FCC Rules.

Operation is subject to the following two conditions:

(1) This device may not cause harmful interference, and
(2) this device must accept any interference received, including interference that may cause undesired operation.

NOTE: This equipment has been tested and found to comply with the limits for a Class B digital device, pursuant to Part 15 of the FCC Rules. These limits are designed to provide reasonable protection against harmful interference in a residential installation.

This equipment generates, uses and can radiate radio frequency energy and, if not installed and used in accordance with the instructions, may cause harmful interference to radio communications.

However, there is no guarantee that interference will not occur in a particular installation. If this equipment does cause harmful interference to radio or television reception, which can be determined by turning the equipment off and on, the user is encouraged to try to correct the interference by one or more of the following measures:

- Reorient or relocate the receiving antenna.
- Increase the separation between the equipment and receiver.
- Connect the equipment into an outlet on a circuit different from that to which the receiver is needed.
- Consult the dealer or an experienced radio/TV technician for help.

Summer Infant stands behind all of its products. If you are not completely satisfied or have any questions, please contact our Consumer Relations Team at **1-401-671-6551** or **www.summerinfant.com/contact**

Summer Infant (USA), Inc.

1275 Park East Drive
Woonsocket, RI 02895 USA
1-401-671-6551
© 2023 Summer Infant, Inc.

Colors and styles may vary.
MADE IN CHINA.
D0000001023B_2.23