

SIDES	BOTTOM
Material: Steel - 0.1793" - STAINLESS STEEL 304	

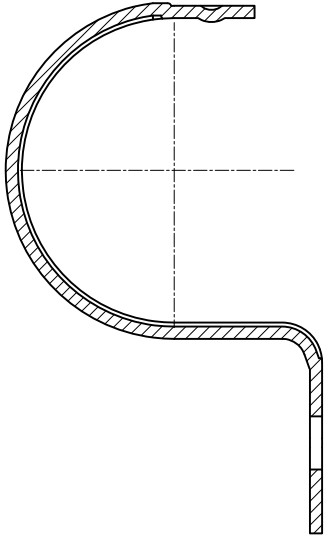

CUTAWAY VIEW B-B

CUTAWAY VIEW A-A

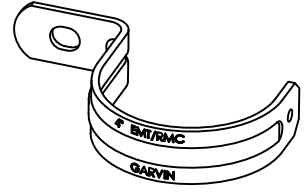
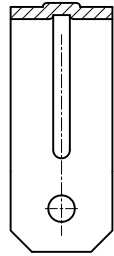
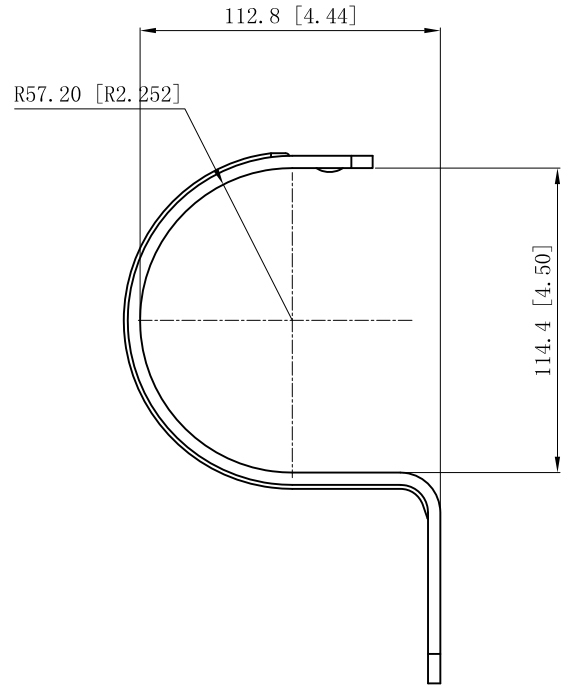
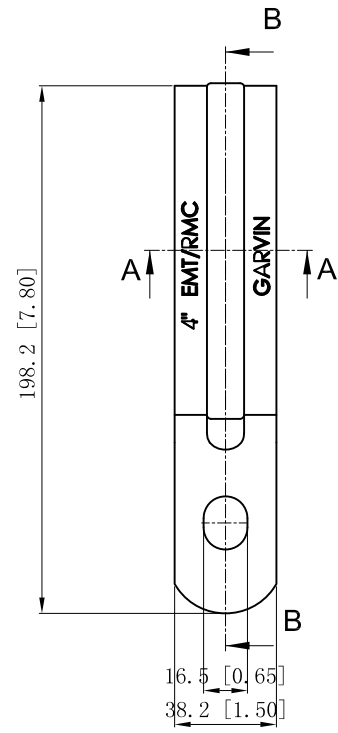

DESCRIPTION
TRADE REFERENCE TERMS

This data sheet is for reference only .GARVIN INDUSTRIES reserves the right to make changes to the design without prior notice.

STANDARD PACKING
10 PCS

GARVIN INDUSTRIES		
TITLE ONE-HOLE STRAPS		
SIZE A4	DWG NO. OHSSR-400	REV
DATA SHEET		