

**Elegant Home Fashions  
Mercer Linen Tower**

**EHF-F0017**

**TIME SAVER!**  
3D Interactive Instruction

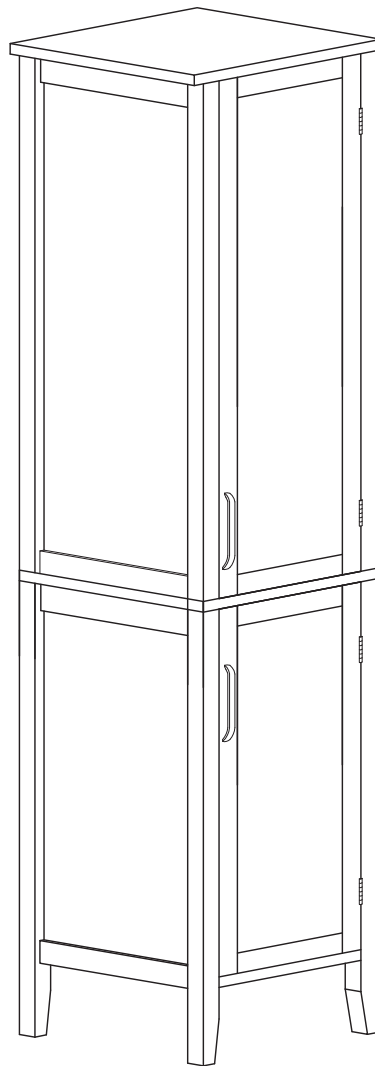

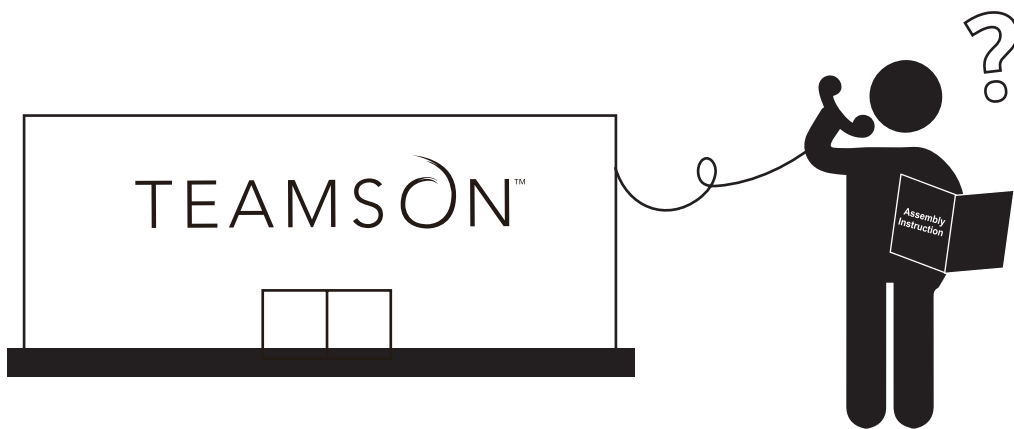
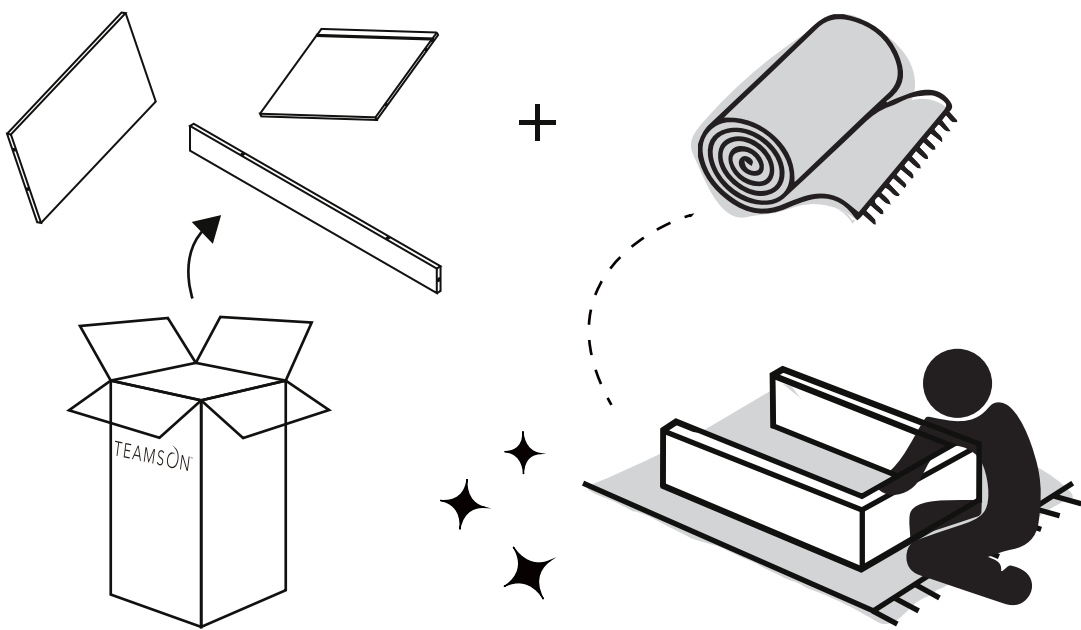
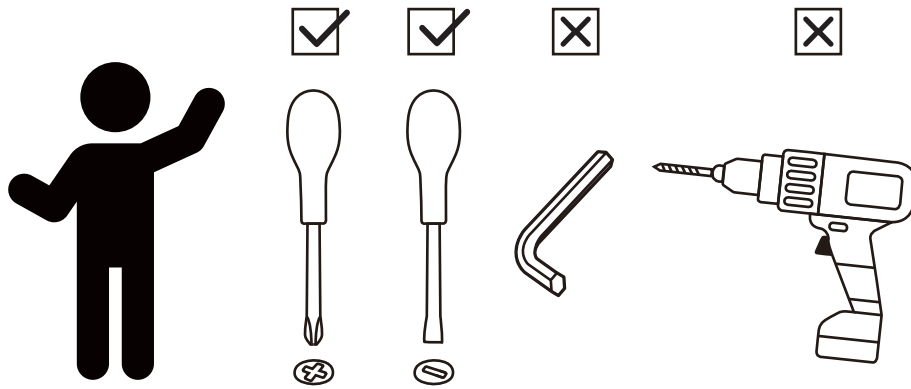

\*\* Got questions? Please have your product code (on the first page of this instruction, e.g. TD-12345A) and the order number ready, give us a call or email us through our customer care support! We are always ready to assist you!

# TEAMSON HOME



Warranty sign up

[www.teamsonhome.com](http://www.teamsonhome.com)

**Serving you well gives us great joy!**

**USA . . . . +1(770)-246-4898**

Mon - Fri 9:00am ~ 5:00pm EST

✉ [service@eleganthf.net](mailto:service@eleganthf.net)

**EU . . . . . +44(0)1952-916-050**

Mon - Thu 9:00am ~ 5:00pm GMT

Friday 9:00am ~ 4:00pm GMT

✉ [support@teamson.co.uk](mailto:support@teamson.co.uk)

#### ASSEMBLY INSTRUCTIONS-IMPORTANT

Carefully unpack & identify each component before attempting to assemble. Refer to parts list. Please take care when assembling the unit and always set the parts on a clean, soft surface. If you require any assistance with assembly, parts, please call the company you place order with or please email to:[service@eleganthf.net](mailto:service@eleganthf.net)

#### INSTRUCCIONES PARA ARMAR-IMPORANT:

Desempaque cuidadosamente e identifique cada componente antes de tartar de empezar su ensambladura. Verifique la lista de partes. Por favor tenga cuidado cuando arme la unidad y siempre coloque las piezas sobre una superficie plana, suave y limpia. Si necesita ayuda con el armado, envíe un correo electzórico a [service@eleganthf.net](mailto:service@eleganthf.net)

#### DIRECTIVES DE MONTAGE-IMPORTANT:

Avant de commencer l' assemblage, déballez délicatement toutes les pièces et repérez-les sur la liste des pièces. Procédez avec soins durant l' assemblage et posez toujours les pièces sur une surface proper, douce et lisse. sie vouo plait e-mail á [service@eleganthf.net](mailto:service@eleganthf.net)

**Thank you for choosing Teamson Home**

# Exploded Drawing

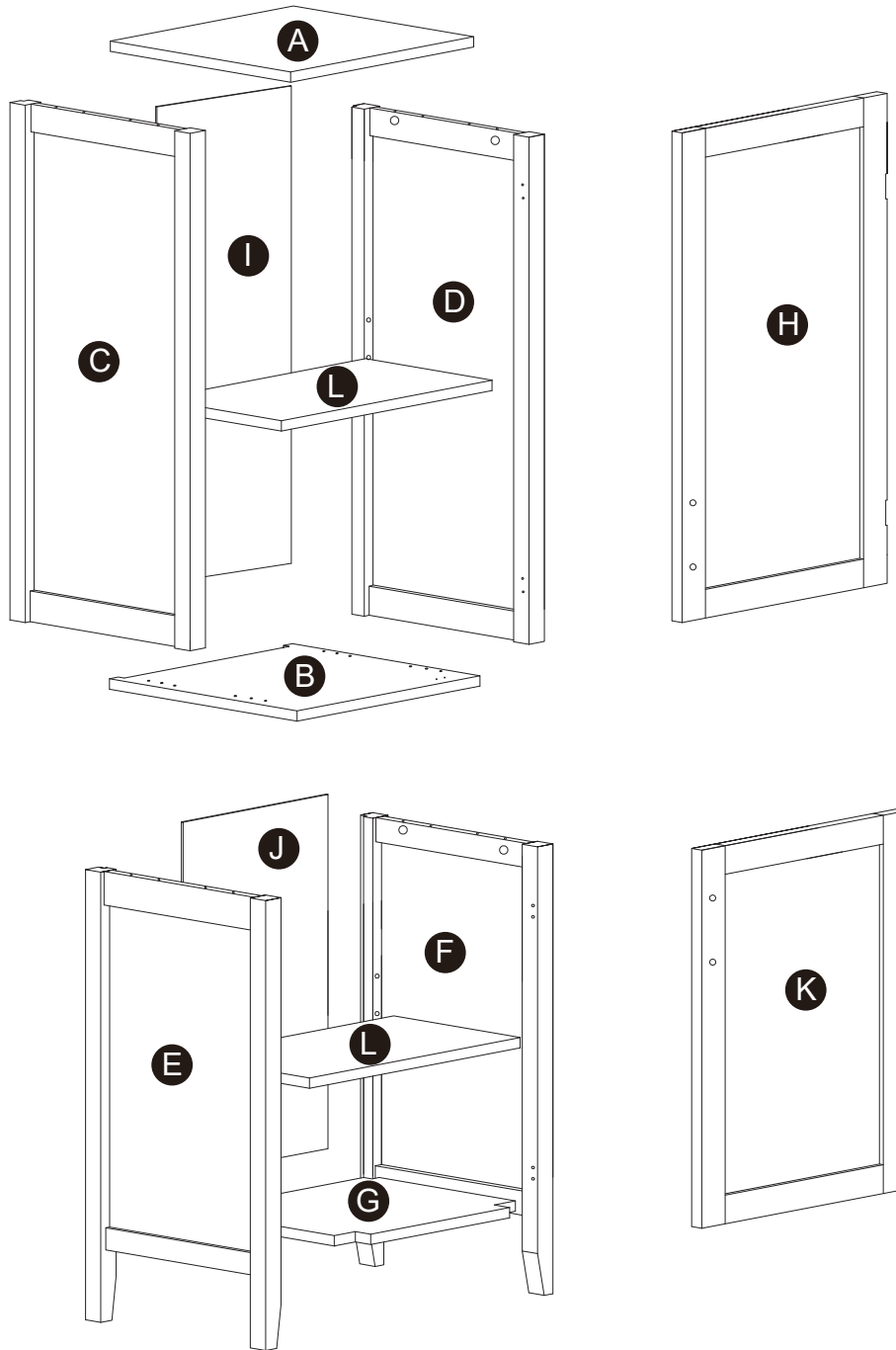

**Questions?**  
Scan Here

## Product Parts

A

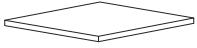

B



C

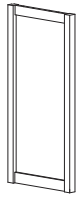

D

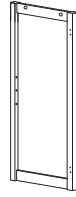

E

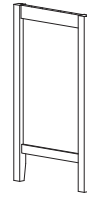

F

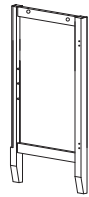

G

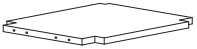

H

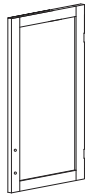

I



J

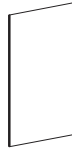

K

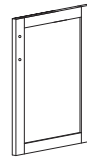

L



2 pcs



**Questions?**  
Scan Here

### **!** WARNING:

1. Do not let any sharp objects touch or rub the surface of the product.
2. When assembling, do not let children play around the working area.
3. Please confirm all parts are correct before starting the assembly process.
4. Do not tighten all bolts and screws completely until the entire unit has been assembled and set up.

# Hardware

1

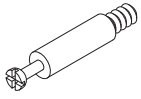

12 pcs

2

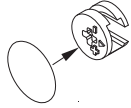

12 pcs

3



8 pcs

4



4 pcs

5

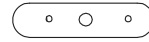

2 pcs

6



2 pcs

7

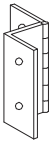

4 pcs

8



18 pcs

9

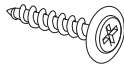

26 pcs

10

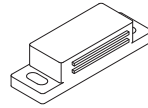

2 pcs

11

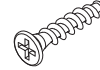

4 pcs

12



2 pcs

13

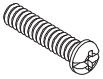

4 pcs

14

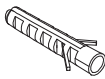

1 pc

15

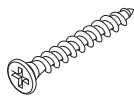

1 pc

16

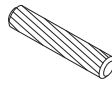

14 pcs

17



4 pcs

18



1 pc

19



1 pc

20



2 pcs

21

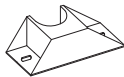

1 pc



Questions?  
Scan Here

# Step 1

- 1
8 pcs
4
4 pcs
8
2 pcs
10
2 pcs
- 11
4 pcs
16
2 pcs
21
1 pc

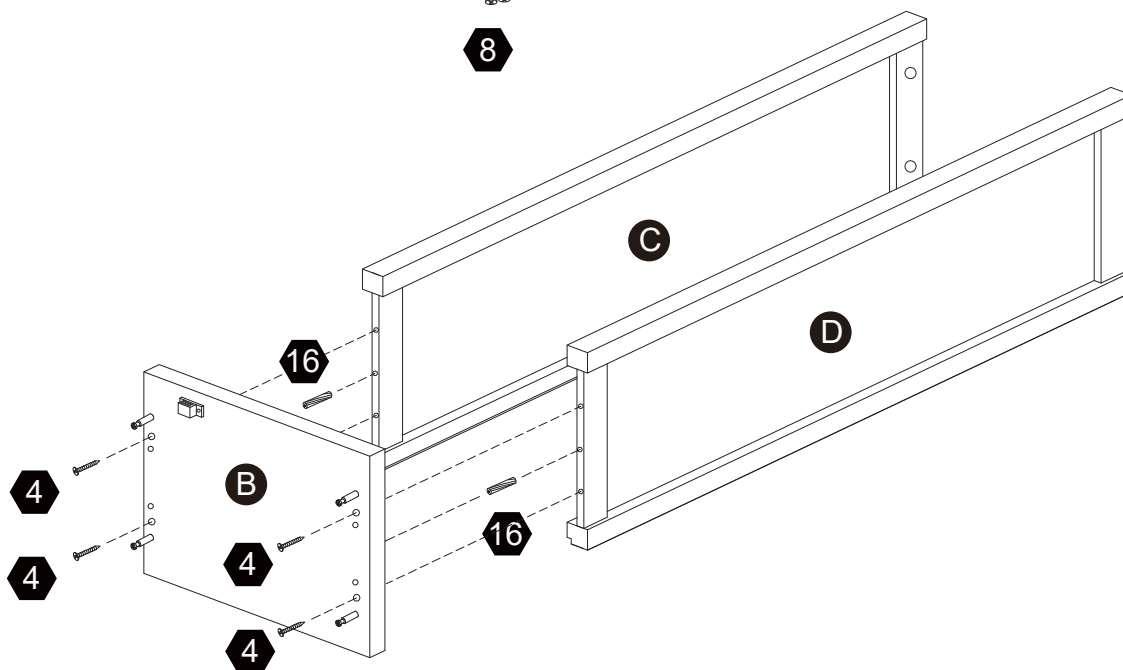
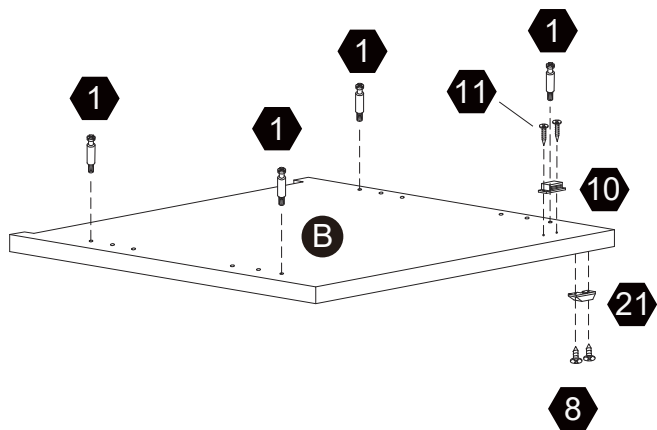
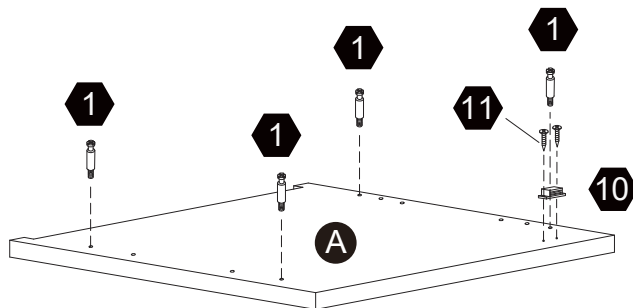

**Questions?**  
 Scan Here

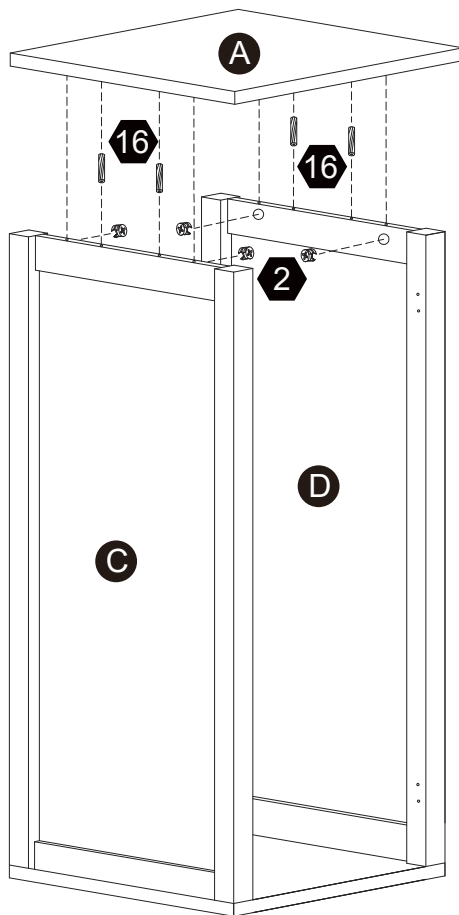
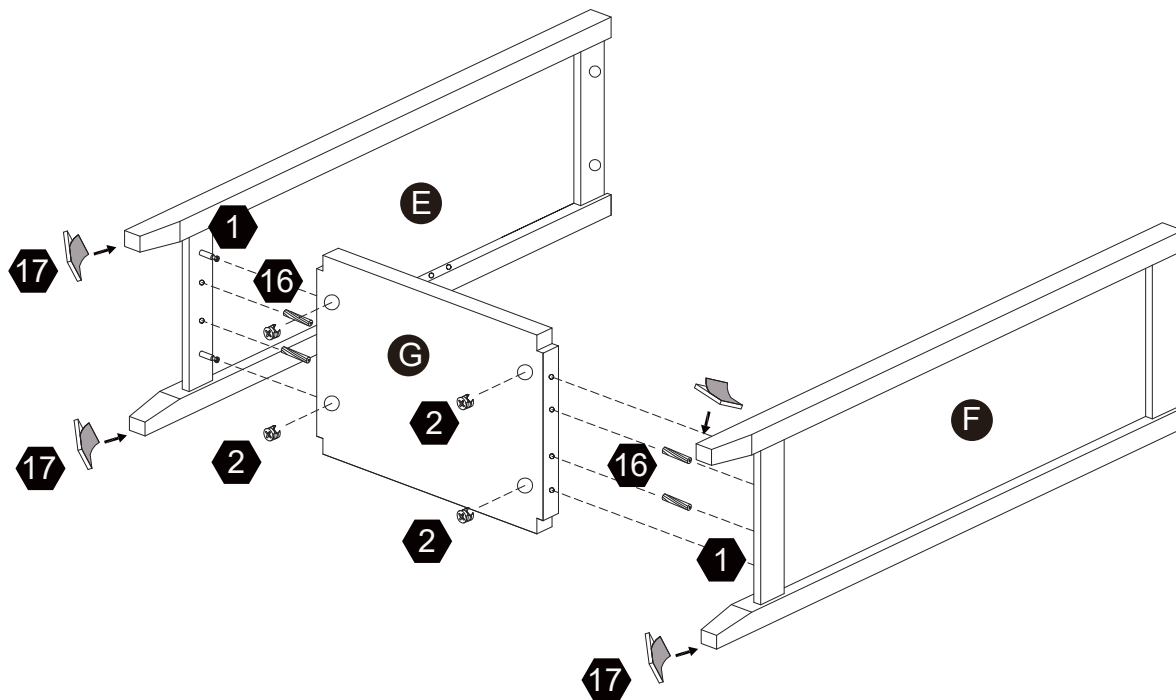

## Step 2



← **Questions?**  
Scan Here

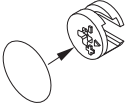

# Step 3

**2**  4 pcs **9**  26 pcs **16**  4 pcs

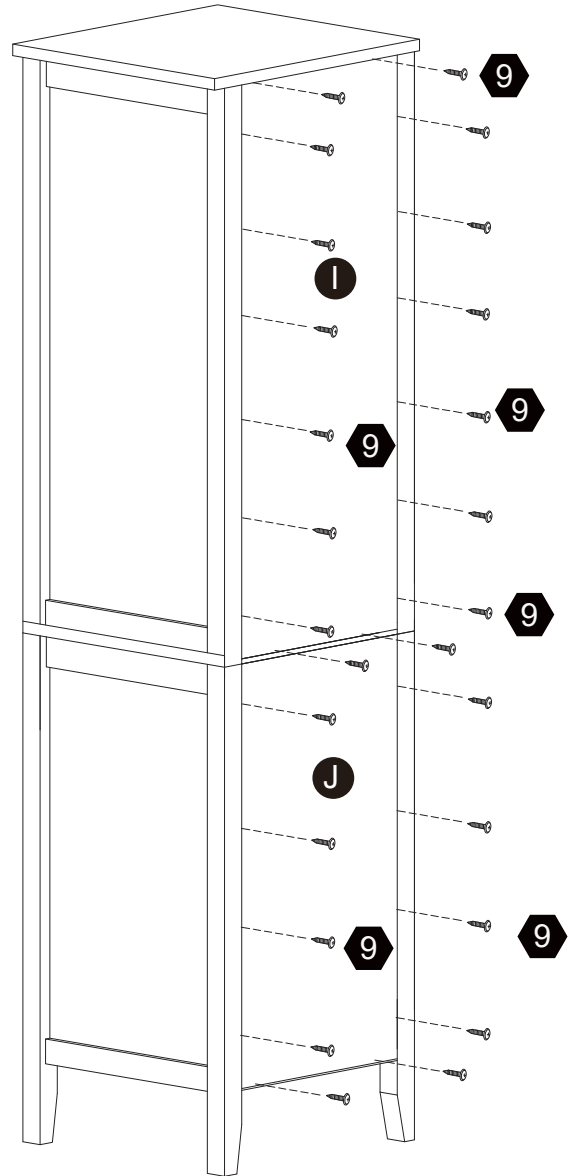
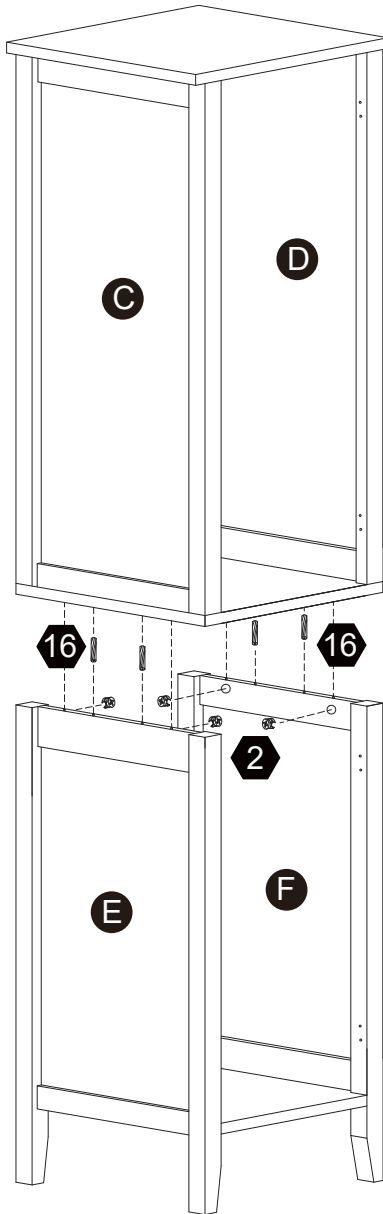

 **Questions?**  
Scan Here

## Step 4

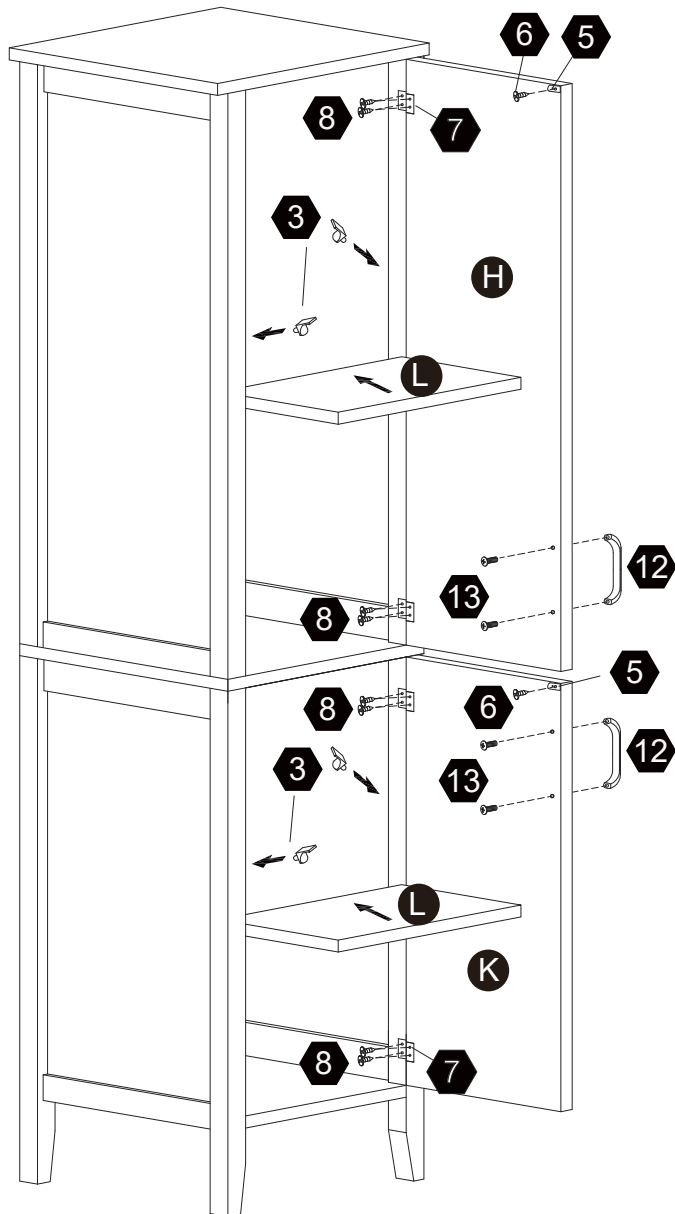
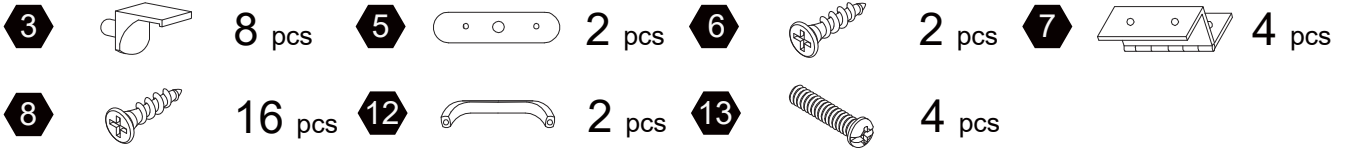

← **Questions?**  
Scan Here

## Step 5

18



1 pc

19



1 pc

20



1 pc

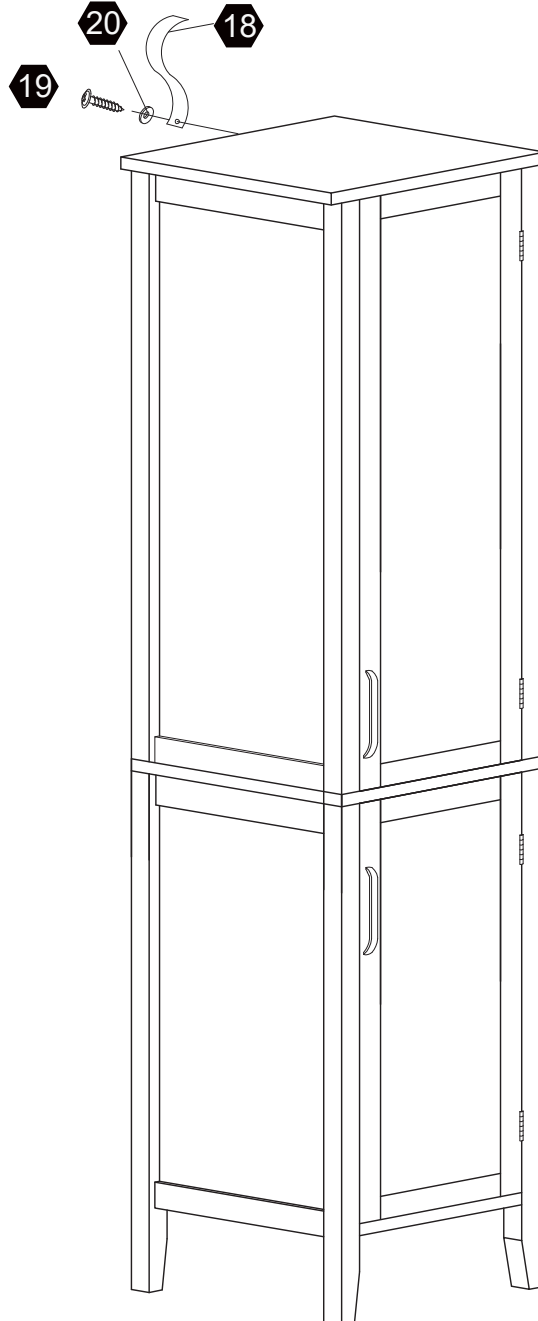

**Questions?**  
Scan Here

## Step 6

14

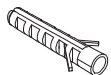

1 pc

15

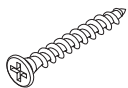

1 pc

20



1 pc

### Warning:

Serious or fatal injuries can occur from furniture tip-over. To help prevent furniture tip-over: Use provided mounting hardware to secure furniture to the wall.

This may reduce but not eliminate the risk of furniture tip-over.

Do not allow children to climb on furniture.

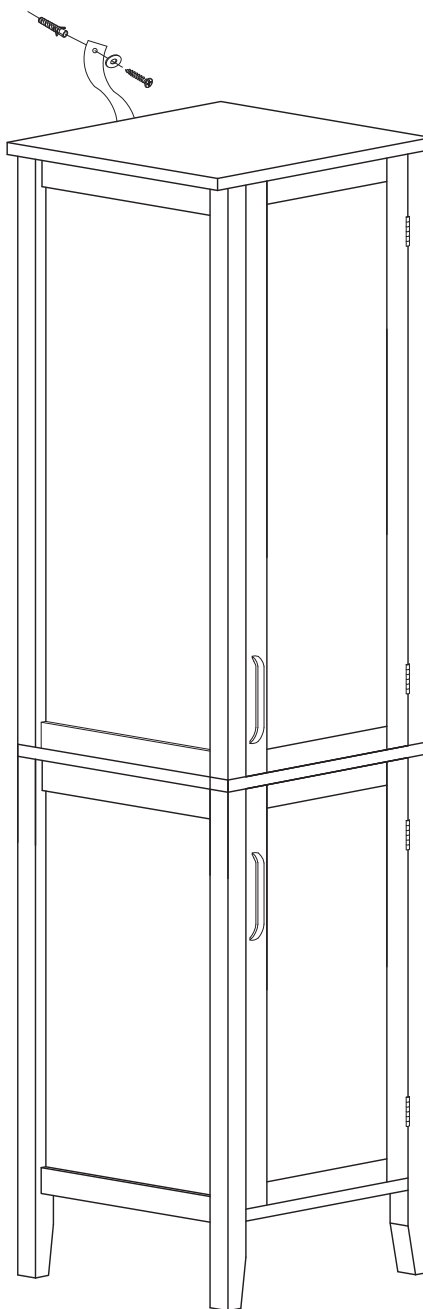
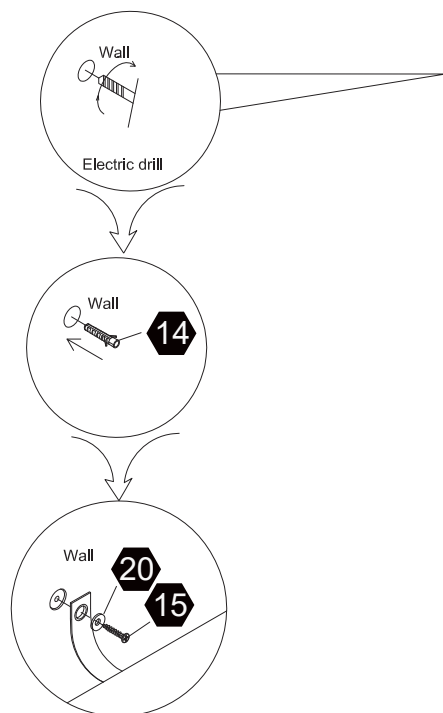

**Questions?**  
Scan Here