

c:\users\y\manivata\building\_drops\inc\building\_drops\inc\ev-24-0946.1 - engineering evaluation - base shoe system and posted glass railing\dwgs\post\_rail\other states\glw001.dwg 1/30/2025 12:18 PM

# FUTUREGLASS GLASS WAREHOUSE

## FABRIKASI POSTED GLASS RAILING SYSTEM

### GENERAL NOTES:

1. THE PRODUCT SHOWN HEREIN IS DESIGNED AND MANUFACTURED TO COMPLY WITH THE CURRENT EDITION OF THE INTERNATIONAL BUILDING CODE (IBC).
2. FOR FALL PROTECTION REQUIREMENTS, THIS PRODUCT HAS BEEN ANALYZED IN ACCORDANCE WITH SECTION 1607.9.1 AND MEETS THE REQUIREMENTS OF THE 50 PLF LINEAR LOAD AND 200 LB CONCENTRATED LOAD SPECIFIED IN ASCE 7 SECTION 4.5.1.
3. ADEQUACY OF THE EXISTING STRUCTURAL CONCRETE/MASONRY AND 2X FRAMING AS A MAIN WIND FORCE RESISTING SYSTEM CAPABLE OF WITHSTANDING AND TRANSFERRING APPLIED PRODUCT LOADS TO THE FOUNDATION IS THE RESPONSIBILITY OF THE ENGINEER OR ARCHITECT OF RECORD FOR THE PROJECT OF INSTALLATION.
4. THE INSTALLATION DETAILS DESCRIBED HEREIN ARE GENERIC AND MAY NOT REFLECT ACTUAL CONDITIONS FOR A SPECIFIC SITE. IF SITE CONDITIONS CAUSE INSTALLATION TO DEVIATE FROM THE REQUIREMENTS DETAILED HEREIN, A LICENSED ENGINEER OR ARCHITECT SHALL PREPARE SITE SPECIFIC DOCUMENTS FOR USE WITH THIS DOCUMENT.
5. APPROVED IMPACT PROTECTIVE SYSTEM **IS REQUIRED** ON THIS PRODUCT IN AREAS REQUIRING IMPACT RESISTANCE.
6. POST MATERIAL: 6063-T5 ALUMINUM
7. GLASS MEETS THE REQUIREMENTS OF ASTM E1300 GLASS CHARTS. SEE SHEET 4 FOR QUALIFIED GLASS OPTIONS.

### INSTRUCTIONS FOR USE:

1. DETERMINE DESIGN WIND LOAD REQUIREMENTS BASED ON WIND VELOCITY, BUILDING HEIGHT, AND WIND ZONE USING THE APPLICABLE ASCE 7 STANDARD. (SEE SHEET 7 FOR TYPICAL WIND LOADS).
2. SEE DESIGN PRESSURE TABLES ON SHEET 3 FOR DESIRED POST SPACING AND POST HEIGHT.
3. SELECT GLASS TYPE FROM SHEET 4 WITH DESIGN PRESSURE HIGHER THAN STEP 1 ABOVE.
4. SELECT ANCHOR TYPE FROM SHEETS 5 & 6 WITH DESIGN PRESSURE HIGHER THAN STEP 1 ABOVE.

TABLE OF CONTENTS	
SHEET	SHEET DESCRIPTION
1	GENERAL NOTES
2	ELEVATION
3	POST DESIGN PRESSURE TABLES
4	GLASS ALLOWABLE WIND LOAD TABLES
5	ANCHOR SCHEDULE AND INSTALLATION DETAIL
6	ALLOWABLE ANCHOR WIND LOAD TABLES
7	ALLOWABLE WIND LOADS PER ASCE 7
8	WIND SPEED MAP

**FUTUREGLASS**

GLASSWAREHOUSE

FUTUREGLASS  
GLASS WAREHOUSE  
1319 ROCKY POINT DRIVE, SUITE 200  
OCEANSIDE, CA 92056

TITLE: FABRIKASI POSTED GLASS RAILING SYSTEM

GENERAL NOTES

PREPARED BY:  
**BUILDING DROPS, INC.**  
1900 NE MIAMI COURT, STE. 2-15  
MIAMI, FL 33132  
PH: (954)399-8478  
FAX: (954)744-4738  
WEB: www.buildingdrops.com



**BUILDING DROPS**

REMARKS	BY	DATE
DRAWING FORMAT UPDATE	DI	11/2024

THE INSTALLATION DETAILS DESCRIBED HEREIN ARE GENERIC AND MAY NOT REFLECT ACTUAL CONDITIONS FOR A SPECIFIC SITE. IF SITE CONDITIONS CAUSE INSTALLATION TO DEVIATE FROM THE REQUIREMENTS DETAILED HEREIN, A LICENSED ENGINEER OR ARCHITECT SHALL PREPARE SITE SPECIFIC DOCUMENTS FOR USE WITH THIS DOCUMENT.

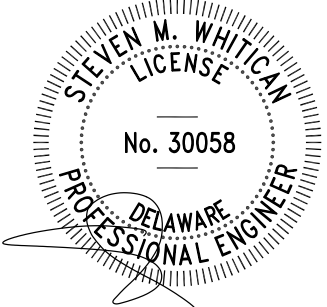

BUILDING DROPS, INC  
1900 NE MIAMI COURT, STE. 2-15  
MIAMI, FL 33132  
FBPE CERT. OF AUTHORIZATION No. 29578

DATE: <b>07.30.2024</b>	
DWG. BY: <b>SH</b>	CHK. BY: <b>HFN</b>
SCALE: <b>NTS</b>	
DWG. #: <b>GLW001</b>	
SHEET: <b>1</b>	
<b>OF 8</b>	

c:\users\y\manivata\building\_drops\inc\building\_drops\landing - common\projects\glass\_warehouse\lc\rev-24-0946.1 - engineering\_evaluation - base shoe system and posted glass railing\dwgs\post\_rail\other states\glw001.dwg 1/30/2025 12:18 PM

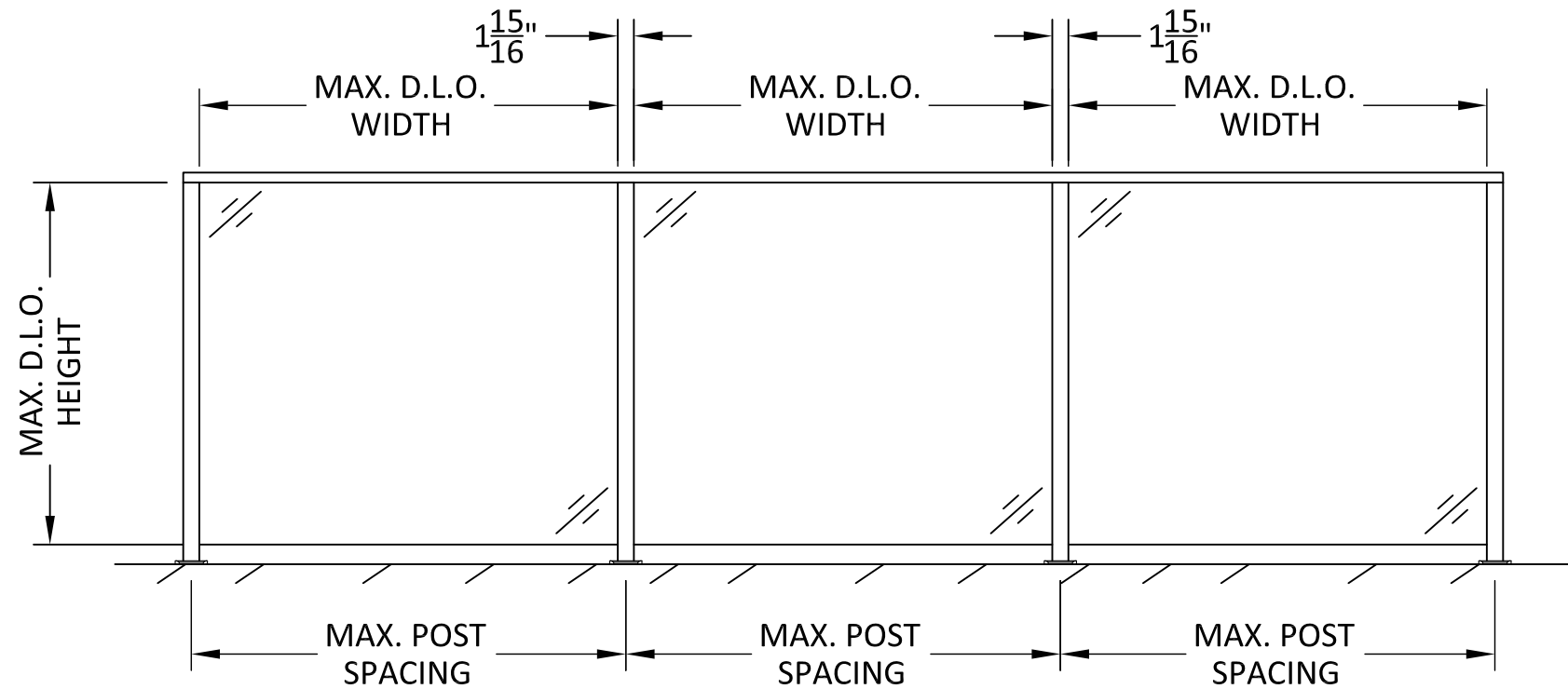

TYPICAL POSTED RAILING ELEVATION

GLASS WIDTH = POST SPACING - .663"  
GLASS HEIGHT = VARIES

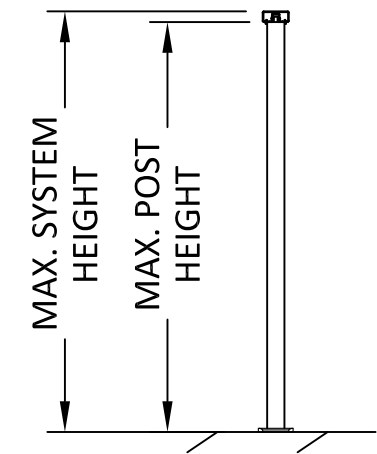

TYPICAL VERTICAL SECTION

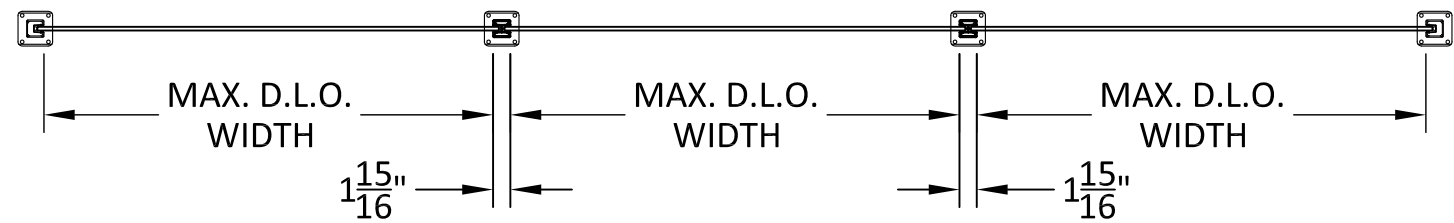

TYPICAL TOP VIEW

**FUTUREGLASS**  
  
GLASSWAREHOUSE  
  
FUTUREGLASS  
GLASS WAREHOUSE  
1319 ROCKY POINT DRIVE, SUITE 200  
OCEANSIDE, CA 92056

TITLE: FABRIKASI POSTED GLASS RAILING SYSTEM  
ELEVATION

PREPARED BY:  
**BUILDING DROPS, INC.**  
1900 NE MIAMI COURT, STE. 2-15  
MIAMI, FL 33132  
PH: (954)399-8478  
FAX: (954)744-4738  
WEB: www.buildingdrops.com



REMARKS	BY	DATE
DRAWING FORMAT UPDATE	DI	11/2024

THE INSTALLATION DETAILS DESCRIBED HEREIN ARE GENERIC AND MAY NOT REFLECT ACTUAL CONDITIONS FOR A SPECIFIC SITE. IF SITE CONDITIONS CAUSE INSTALLATION TO DEVIATE FROM THE REQUIREMENTS DETAILED HEREIN, A LICENSED ENGINEER OR ARCHITECT SHALL PREPARE SITE SPECIFIC DOCUMENTS FOR USE WITH THIS DOCUMENT.

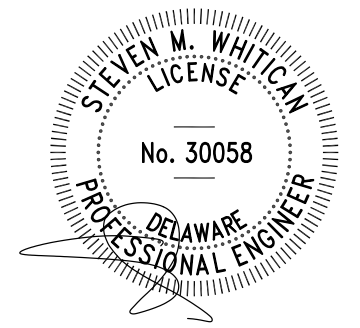

BUILDING DROPS, INC  
1900 NE MIAMI COURT, STE. 2-15  
MIAMI, FL 33132  
FBPE CERT. OF AUTHORIZATION No. 29578

DATE:	07.30.2024	
DWG. BY:	SH	CHK. BY: HFN
SCALE:	NTS	
DWG. #:	GLW001	

SHEET:  
**2**  
OF 8

## INTERMEDIATE POST

ALLOWABLE INTERMEDIATE POST WIND LOAD (PSF)								
POST HEIGHT (IN.)	POST SPACING (IN.)							
	36	42	48	54	60	66	72	78
36	87.7	75.1	65.7	58.4	52.6	47.8	43.8	40.5
42	64.4	55.2	48.3	42.9	38.6	35.1	32.2	29.7
48	49.3	42.3	37.0	32.9	29.6	26.9	24.7	22.8
54	39.0	33.4	29.2	26.0	23.4	21.3	-	-
60	31.6	27.1	23.7	21.0	18.9	-	-	-

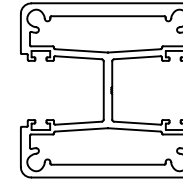

## END POST

ALLOWABLE INTERMEDIATE POST WIND LOAD (PSF)								
POST HEIGHT (IN.)	POST SPACING (IN.)							
	36	42	48	54	60	66	72	78
36	166.9	143.0	125.2	111.2	100.1	91.0	83.4	77.0
42	122.6	105.1	91.9	81.7	73.6	66.9	61.3	56.6
48	93.9	80.5	70.4	62.6	56.3	51.2	46.9	43.3
54	74.2	63.6	55.6	49.4	44.5	40.5	37.1	34.2
60	60.1	51.5	45.1	40.0	36.0	32.8	30.0	27.7

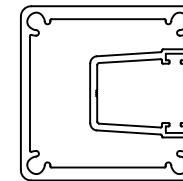

## 90 DEGREE CORNER POST

ALLOWABLE INTERMEDIATE POST WIND LOAD (PSF)								
POST HEIGHT (IN.)	POST SPACING (IN.)							
	36	42	48	54	60	66	72	78
36	133.5	114.4	100.1	89.0	80.1	72.8	66.7	61.6
42	98.1	84.1	73.6	65.4	58.8	53.5	49.0	45.3
48	75.1	64.4	56.3	50.1	45.1	41.0	37.5	34.7
54	59.3	50.9	44.5	39.6	35.6	32.4	29.7	27.4
60	-	-	-	-	-	-	-	-

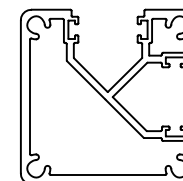

FUTUREGLASS

GLASSWAREHOUSE

FUTUREGLASS  
GLASS WAREHOUSE  
1319 ROCKY POINT DRIVE, SUITE 200  
OCEANSIDE, CA 92056

TITLE: FABRIKASI POSTED GLASS  
RAILING SYSTEM

POST DESIGN  
PRESSURE TABLES

PREPARED BY: BUILDING DROPS, INC.

1900 NE MIAMI COURT, STE. 2-15  
MIAMI, FL 33132  
PH: (954)399-8478  
FAX: (954)744-4738  
WEB: www.buildingdrops.com



REMARKS	BY	DATE
DRAWING FORMAT UPDATE	DI	11/2024

THE INSTALLATION DETAILS DESCRIBED HEREIN ARE GENERIC AND MAY NOT REFLECT ACTUAL CONDITIONS FOR A SPECIFIC SITE. IF SITE CONDITIONS CAUSE INSTALLATION TO DEVIATE FROM THE REQUIREMENTS DETAILED HEREIN, A LICENSED ENGINEER OR ARCHITECT SHALL PREPARE SITE SPECIFIC DOCUMENTS FOR USE WITH THIS DOCUMENT.

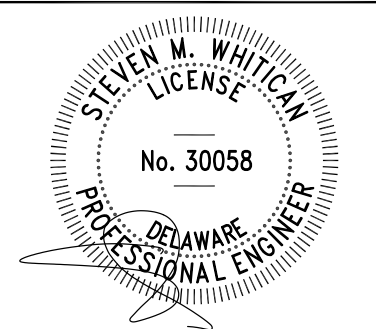

BUILDING DROPS, INC  
1900 NE MIAMI COURT, STE. 2-15  
MIAMI, FL 33132  
FBPE CERT. OF AUTHORIZATION No. 29578

DATE: 07.30.2024

DWG. BY: SH  
CHK. BY: HFN

SCALE: NTS

DWG. #: GLW001

SHEET:

3

OF 8

# GLASS ALLOWABLE WIND LOAD TABLES

TABLE 2: 5/16" MONOLITHIC TEMPERED GLASS

ALLOWABLE GLASS WIND LOAD TABLE (PSF)								
GLASS HEIGHT (IN)	POST SPACING (IN)							
	36.0	42.0	48.0	54.0	60.0	66.0	72.0	78.0
36.0	121.3	89.1	68.2	-	-	-	-	-
42.0	121.3	89.1	68.2	53.9	-	-	-	-
48.0	121.3	89.1	68.2	53.9	43.7	-	-	-
54.0	121.3	89.1	68.2	53.9	43.7	36.1	-	-
60.0	121.3	89.1	68.2	53.9	43.7	36.1	30.3	-

TABLE 3: 3/8" MONOLITHIC TEMPERED GLASS

ALLOWABLE GLASS WIND LOAD TABLE (PSF)								
GLASS HEIGHT (IN)	POST SPACING (IN)							
	36.0	42.0	48.0	54.0	60.0	66.0	72.0	78.0
36.0	179.2	131.7	100.8	79.7	64.5	53.3	44.8	-
42.0	179.2	131.7	100.8	79.7	64.5	53.3	44.8	38.2
48.0	179.2	131.7	100.8	79.7	64.5	53.3	44.8	38.2
54.0	179.2	131.7	100.8	79.7	64.5	53.3	44.8	38.2
60.0	179.2	131.7	100.8	79.7	64.5	53.3	44.8	38.2

TABLE 4: 1/2" MONOLITHIC TEMPERED GLASS

ALLOWABLE GLASS WIND LOAD TABLE (PSF)								
GLASS HEIGHT (IN)	POST SPACING (IN)							
	36.0	42.0	48.0	54.0	60.0	66.0	72.0	78.0
36.0	312.9	229.9	176.0	139.1	112.6	93.1	78.2	66.7
42.0	312.9	229.9	176.0	139.1	112.6	93.1	78.2	66.7
48.0	312.9	229.9	176.0	139.1	112.6	93.1	78.2	66.7
54.0	312.9	229.9	176.0	139.1	112.6	93.1	78.2	66.7
60.0	312.9	229.9	176.0	139.1	112.6	93.1	78.2	66.7

TABLE 4: 7/16" O.A. LAMINATED GLASS: 3/16" TEMPERED GLASS - 0.060" PVB - 3/16" TEMPERED GLASS

ALLOWABLE GLASS WIND LOAD TABLE (PSF)								
GLASS HEIGHT (IN)	POST SPACING (IN)							
	36.0	42.0	48.0	54.0	60.0	66.0	72.0	78.0
36.0	136.8	108.2	88.4	73.9	-	-	-	-
42.0	136.8	108.2	88.4	73.9	62.9	54.2	-	-
48.0	136.8	108.2	88.4	73.9	62.9	54.2	47.2	41.5
54.0	136.8	108.2	88.4	73.9	62.9	54.2	47.2	41.5
60.0	136.8	108.2	88.4	73.9	62.9	54.2	47.2	41.5

TABLE 5: 7/16" O.A. LAMINATED GLASS: 3/16" TEMPERED GLASS - 0.060" SENTRYGLAS - 3/16" TEMPERED GLASS

ALLOWABLE GLASS WIND LOAD TABLE (PSF)								
GLASS HEIGHT (IN)	POST SPACING (IN)							
	36.0	42.0	48.0	54.0	60.0	66.0	72.0	78.0
36.0	234.7	175.2	135.6	108.0	87.9	73.0	61.5	52.5
42.0	234.7	175.2	135.6	108.0	87.9	73.0	61.5	52.5
48.0	234.7	175.2	135.6	108.0	87.9	73.0	61.5	52.5
54.0	234.7	175.2	135.6	108.0	87.9	73.0	61.5	52.5
60.0	234.7	175.2	135.6	108.0	87.9	73.0	61.5	52.5

TABLE 6: 9/16" O.A. LAMINATED GLASS: 1/4" TEMPERED GLASS - 0.060" PVB - 1/4" TEMPERED GLASS

ALLOWABLE GLASS WIND LOAD TABLE (PSF)								
GLASS HEIGHT (IN)	POST SPACING (IN)							
	36.0	42.0	48.0	54.0	60.0	66.0	72.0	78.0
36.0	188.1	147.8	120.3	100.4	85.3	73.6	64.2	-
42.0	188.1	147.8	120.3	100.4	85.3	73.6	64.2	56.5
48.0	188.1	147.8	120.3	100.4	85.3	73.6	64.2	56.5
54.0	188.1	147.8	120.3	100.4	85.3	73.6	64.2	56.5
60.0	188.1	147.8	120.3	100.4	85.3	73.6	64.2	56.5

TABLE 7: 9/16" O.A. LAMINATED GLASS: 1/4" TEMPERED GLASS - 0.060" SENTRYGLAS - 1/4" TEMPERED GLASS

ALLOWABLE GLASS WIND LOAD TABLE (PSF)								
GLASS HEIGHT (IN)	POST SPACING (IN)							
	36.0	42.0	48.0	54.0	60.0	66.0	72.0	78.0
36.0	326.4	244.4	189.5	151.1	123.2	102.3	86.3	73.7
42.0	326.4	244.4	189.5	151.1	123.2	102.3	86.3	73.7
48.0	326.4	244.4	189.5	151.1	123.2	102.3	86.3	73.7
54.0	326.4	244.4	189.5	151.1	123.2	102.3	86.3	73.7
60.0	326.4	244.4	189.5	151.1	123.2	102.3	86.3	73.7

FUTUREGLASS

GLASSWAREHOUSE

FUTUREGLASS  
GLASS WAREHOUSE  
1319 ROCKY POINT DRIVE, SUITE 200  
OCEANSIDE, CA 92056

TITLE: FABRIKASI POSTED GLASS RAILING SYSTEM

GLASS ALLOWABLE WIND LOAD TABLES

PREPARED BY: BUILDING DROPS, INC.

1900 NE MIAMI COURT, STE. 2-15  
MIAMI, FL 33132  
PH: (954)399-8478  
FAX: (954)744-4738  
WEB: www.buildingdrops.com



REMARKS	BY	DATE
DRAWING FORMAT UPDATE	DI	11/2024

THE INSTALLATION DETAILS DESCRIBED HEREIN ARE GENERIC AND MAY NOT REFLECT ACTUAL CONDITIONS FOR A SPECIFIC SITE. IF SITE CONDITIONS CAUSE INSTALLATION TO DEVIATE FROM THE REQUIREMENTS DETAILED HEREIN, A LICENSED ENGINEER OR ARCHITECT SHALL PREPARE SITE SPECIFIC DOCUMENTS FOR USE WITH THIS DOCUMENT.

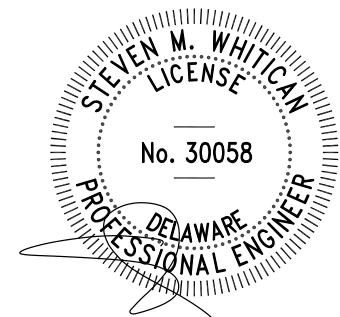

BUILDING DROPS, INC  
1900 NE MIAMI COURT, STE. 2-15  
MIAMI, FL 33132  
FBPE CERT. OF AUTHORIZATION No. 29578

DATE: 07.30.2024

DWG. BY: SH      CHK. BY: HFN

SCALE: NTS

DWG. #: GLW001

SHEET:

4

OF 8

c:\users\y\Documents\building\_drops\nc\building\_drops\glass\_warehouse\_lic\rev-24-09\46.1 - engineering evaluation - base shoe system and posted glass railing\dwgs\post\_railing\other states\glw001.dwg 1/30/2025 12:18 PM

c:\users\y\antwata\building\_drops\nc\building\_drops\warehouse\_1c\rev-24-0946.1 - engineering evaluation - base shoe system and posted glass railing\dwg\post\_rail\other states\glw001.dwg 1/30/2025 12:18 PM

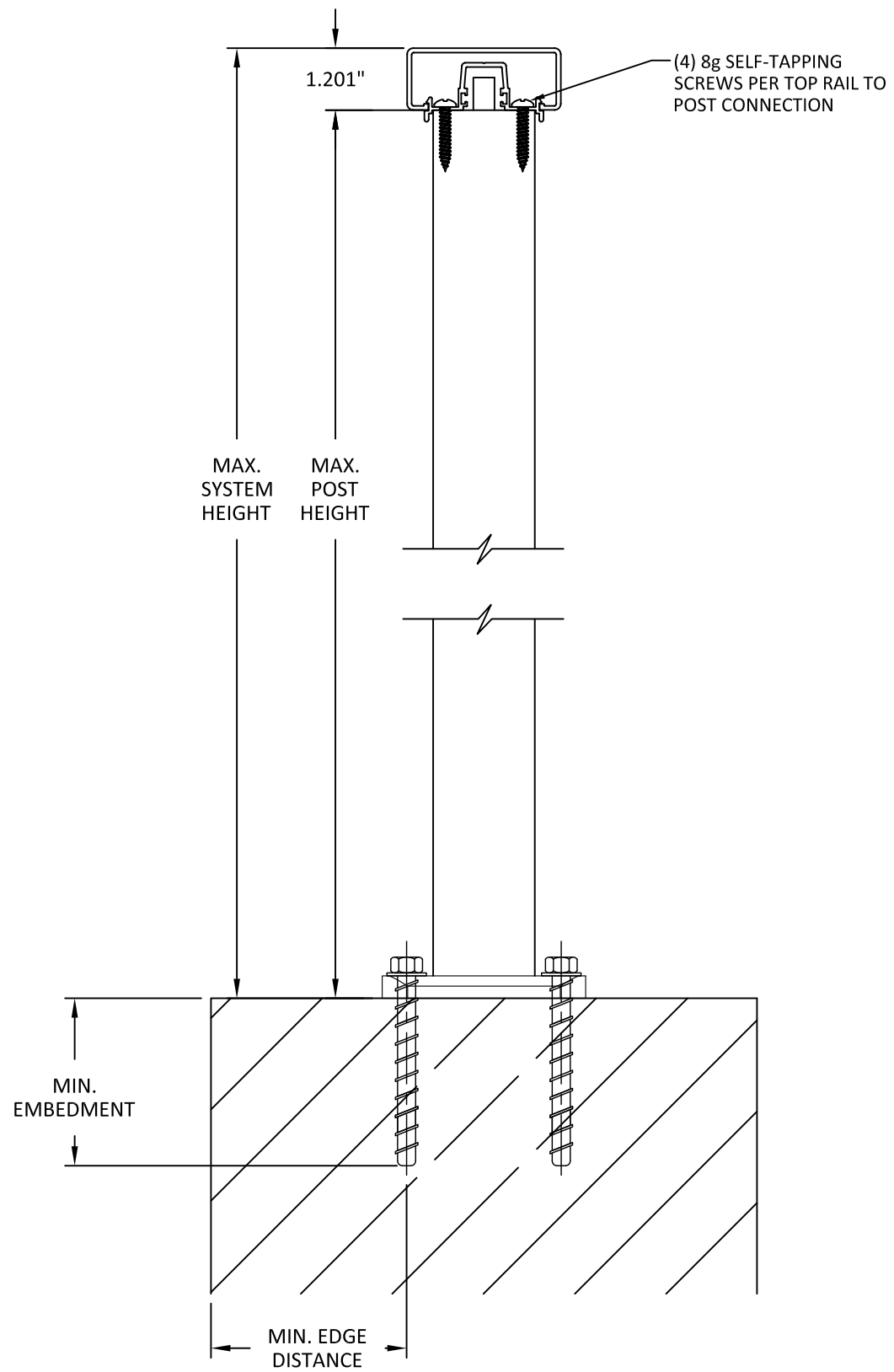

ANCHOR SCHEDULE						
OPTION	ANCHOR TYPE	BRAND	SUBSTRATE	EMBEDMENT (IN)	EDGE DISTANCE (IN)	ANCHOR QUANTITY
A	WOOD	5/16" LAG SCREW	0.55 S.G.	1.5000	0.7500	4
B		3/8" LAG SCREW	0.55 S.G.	1.5000	0.7500	4
C		1/2" LAG SCREW	0.55 S.G.	1.5000	0.7500	4
D	STEEL	5/16" SELF-TAPPING SCREW	45000 PSI	3 THREADS	0.5000	4
E		3/8" SELF-TAPPING SCREW	45000 PSI	3 THREADS	0.5000	4
F		1/2" SELF-TAPPING SCREW	45000 PSI	3 THREADS	0.5000	4
G	CONCRETE	1/4" DEWALT SCREW-BOLT+	3000 PSI	2.5000	3.0000	4
H		3/8" DEWALT SCREW-BOLT+	3000 PSI	2.5000	3.0000	4
I		1/2" DEWALT SCREW-BOLT+	3000 PSI	2.5000	3.0000	4

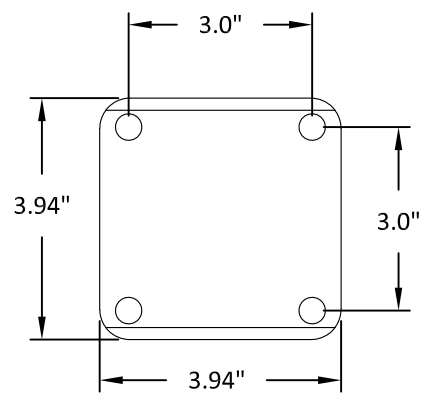

BASE PLATE TOP VIEW

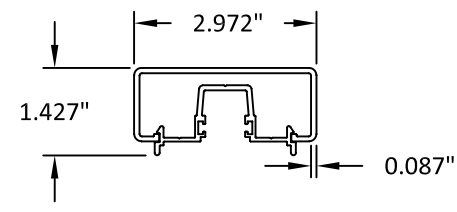

GSW005/006 TOP RAIL:  
• MAX. SPAN: 7.33 FT

**FUTUREGLASS**  
GLASSWAREHOUSE  
FUTUREGLASS  
GLASS WAREHOUSE  
1319 ROCKY POINT DRIVE, SUITE 200  
OCEANSIDE, CA 92056

TITLE: **FABRIKASI POSTED GLASS RAILING SYSTEM**  
ANCHOR SCHEDULE & INSTALLATION DETAIL

PREPARED BY: **BUILDING DROPS, INC.**  
1900 NE MIAMI COURT, STE. 2-15  
MIAMI, FL 33132  
PH: (954)399-8478  
FAX: (954)744-4738  
WEB: www.buildingdrops.com



REMARKS	BY	DATE
DRAWING FORMAT UPDATE	DI	11/2024

THE INSTALLATION DETAILS DESCRIBED HEREIN ARE GENERIC AND MAY NOT REFLECT ACTUAL CONDITIONS FOR A SPECIFIC SITE. IF SITE CONDITIONS CAUSE INSTALLATION TO DEVIATE FROM THE REQUIREMENTS DETAILED HEREIN, A LICENSED ENGINEER OR ARCHITECT SHALL PREPARE SITE SPECIFIC DOCUMENTS FOR USE WITH THIS DOCUMENT.

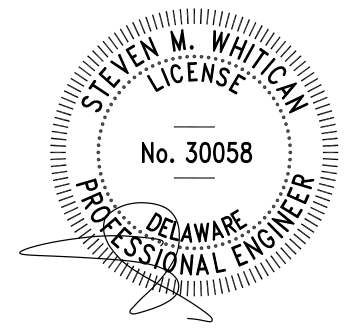

BUILDING DROPS, INC  
1900 NE MIAMI COURT, STE. 2-15  
MIAMI, FL 33132  
FBPE CERT. OF AUTHORIZATION No. 29578

DATE: <b>07.30.2024</b>
DWG. BY: <b>SH</b> CHK. BY: <b>HFN</b>
SCALE: <b>NTS</b>
DWG. #: <b>GLW001</b>

SHEET:  
**5**  
OF 8

# ALLOWABLE ANCHOR WIND LOAD TABLES

## ANCHOR TYPE G

ALLOWABLE ANCHOR WIND LOAD (PSF)								
POST HEIGHT (IN.)	POST SPACING (IN.)							
	36	42	48	54	60	66	72	78
36	43.6	37.4	32.7	29.1	26.2	23.8	21.8	20.1
42	32.0	27.5	24.0	21.4	19.2	17.5	16.0	14.8
48	24.5	21.0	18.4	16.3	14.7	13.4	12.3	11.3
54	19.4	16.6	14.5	12.9	11.6	10.6	9.7	8.9
60	15.7	13.5	11.8	10.5	9.4	8.6	7.8	7.2

## ANCHOR TYPES: B, E, & H

ALLOWABLE ANCHOR WIND LOAD (PSF)								
POST HEIGHT (IN.)	POST SPACING (IN.)							
	36	42	48	54	60	66	72	78
36	56.7	48.6	42.5	37.8	34.0	30.9	28.4	26.2
42	41.7	35.7	31.2	27.8	25.0	22.7	20.8	19.2
48	31.9	27.3	23.9	21.3	19.1	17.4	15.9	14.7
54	25.2	21.6	18.9	16.8	15.1	13.7	12.6	11.6
60	20.4	17.5	15.3	13.6	12.2	11.1	10.2	9.4

## ANCHOR TYPES: A & D

ALLOWABLE ANCHOR WIND LOAD (PSF)								
POST HEIGHT (IN.)	POST SPACING (IN.)							
	36	42	48	54	60	66	72	78
36	48.4	41.5	36.3	32.3	29.1	26.4	24.2	22.4
42	35.6	30.5	26.7	23.7	21.4	19.4	17.8	16.4
48	27.3	23.4	20.4	18.2	16.4	14.9	13.6	12.6
54	21.5	18.5	16.1	14.4	12.9	11.7	10.8	9.9
60	17.4	14.9	13.1	11.6	10.5	9.5	8.7	8.0

## ANCHOR TYPES: C, F, & I

ALLOWABLE ANCHOR WIND LOAD (PSF)								
POST HEIGHT (IN.)	POST SPACING (IN.)							
	36	42	48	54	60	66	72	78
36	70.4	60.4	52.8	47.0	42.3	38.4	35.2	32.5
42	51.8	44.4	38.8	34.5	31.1	28.2	25.9	23.9
48	39.6	34.0	29.7	26.4	23.8	21.6	19.8	18.3
54	31.3	26.8	23.5	20.9	18.8	17.1	15.7	14.4
60	25.4	21.7	19.0	16.9	15.2	13.8	12.7	11.7

FUTUREGLASS

GLASSWAREHOUSE

FUTUREGLASS  
GLASS WAREHOUSE  
1319 ROCKY POINT DRIVE, SUITE 200  
OCEANSIDE, CA 92056

TITLE: FABRIKASI POSTED GLASS RAILING SYSTEM

ALLOWABLE ANCHOR WIND LOAD TABLES

PREPARED BY: BUILDING DROPS, INC.

1900 NE MIAMI COURT, STE. 2-15  
MIAMI, FL 33132  
PH: (954)399-8478  
FAX: (954)744-4738  
WEB: www.buildingdrops.com



REMARKS	BY	DATE
DRAWING FORMAT UPDATE	DI	11/2024

THE INSTALLATION DETAILS DESCRIBED HEREIN ARE GENERIC AND MAY NOT REFLECT ACTUAL CONDITIONS FOR A SPECIFIC SITE. IF SITE CONDITIONS CAUSE INSTALLATION TO DEVIATE FROM THE REQUIREMENTS DETAILED HEREIN, A LICENSED ENGINEER OR ARCHITECT SHALL PREPARE SITE SPECIFIC DOCUMENTS FOR USE WITH THIS DOCUMENT.

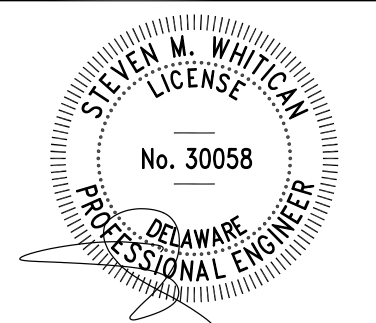

BUILDING DROPS, INC  
1900 NE MIAMI COURT, STE. 2-15  
MIAMI, FL 33132  
FBPE CERT. OF AUTHORIZATION No. 29578

DATE:	07.30.2024
DWG. BY:	SH
CHK. BY:	HFN
SCALE:	NTS
DWG. #:	GLW001

SHEET:  
**6**  
OF 8



c:\users\y\manwata\building\_drops\inc\building\_drops\_projects\glass\_warehouse\lc\rev-24-09\6.1 - engineering evaluation - base shoe system and posted glass railing\dwg\post\_rail\other states\glw001.dwg 1/30/2025 12:18 PM

# WIND SPEED MAP

mph (m/sec.)

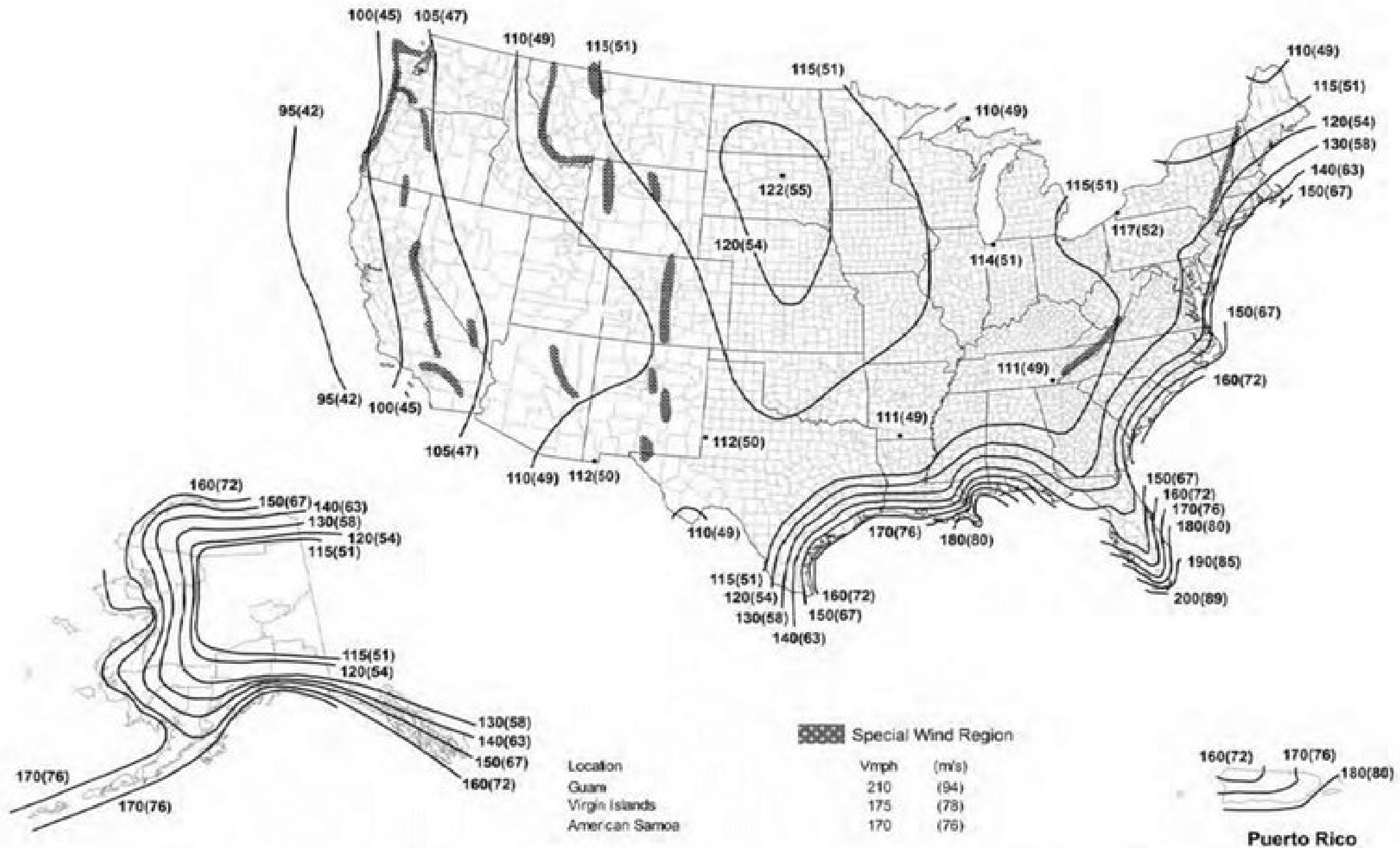

FUTUREGLASS

GLASSWAREHOUSE

FUTUREGLASS  
GLASS WAREHOUSE  
1319 ROCKY POINT DRIVE, SUITE 200  
OCEANSIDE, CA 92056

TITLE: FABRIKASI POSTED GLASS RAILING SYSTEM

WIND SPEED MAP

PREPARED BY: BUILDING DROPS, INC.

1900 NE MIAMI COURT, STE. 2-15  
MIAMI, FL 33132  
PH: (954)399-8478  
FAX: (954)744-4738  
WEB: www.buildingdrops.com



REMARKS	BY	DATE
DRAWING FORMAT UPDATE	DI	11/2024

THE INSTALLATION DETAILS DESCRIBED HEREIN ARE GENERIC AND MAY NOT REFLECT ACTUAL CONDITIONS FOR A SPECIFIC SITE. IF SITE CONDITIONS CAUSE INSTALLATION TO DEVIATE FROM THE REQUIREMENTS DETAILED HEREIN, A LICENSED ENGINEER OR ARCHITECT SHALL PREPARE SITE SPECIFIC DOCUMENTS FOR USE WITH THIS DOCUMENT.

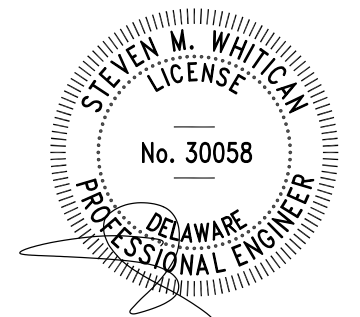

BUILDING DROPS, INC  
1900 NE MIAMI COURT, STE. 2-15  
MIAMI, FL 33132  
FBPE CERT. OF AUTHORIZATION No. 29578

DATE:	07.30.2024	
DWG. BY:	SH	CHK. BY: HFN
SCALE:	NTS	
DWG. #:	GLW001	

SHEET:  
**8**  
OF 8