

Features

- Two Lever handles offer separate control of hot and cold water
- 5-15/16" (151 mm) spout reach
- 1.2 gpm (4.5 lpm) maximum flow rate at 60 psi (4.14 bar)
- KOHLER® ceramic disc valves exceed industry longevity standards for a lifetime of durable performance
- Clicker drain with tailpiece and overflow
- Coordinates with other products in the Tone collection
- This product can help a building earn Water Efficiency points in LEED® Green Building Rating System

Material

- Premium material construction for durability and reliability
- KOHLER finishes resist corrosion and tarnishing

Installation

- For 8" – 16" (203 – 406 mm) centers
- Deck-mount
- Handles are preassembled on valves to simplify installation

Recommended Products/Accessories

- K-23726 Drain treatment
- K-27425 18" towel bar
- K-27426 24" towel bar
- K-27427 Robe hook
- K-27428 Towel ring
- K-27429 Pivoting toilet paper holder

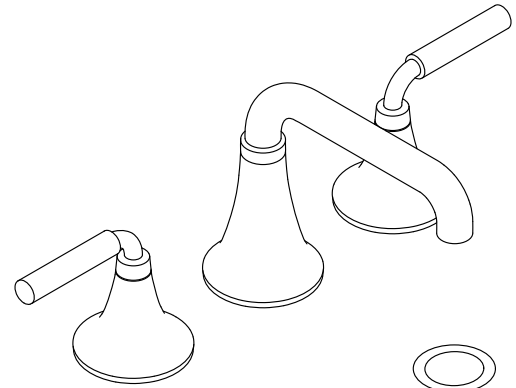

Codes/Standards





- ASME A112.18.1/CSA B125.1
- NSF/ANSI/CAN 61
- NSF/ANSI/CAN 372
- DOE - Energy Policy Act 1992
- EPA WaterSense®
- California Energy Commission (CEC)
- ADA
- ICC/ANSI A117.1
- CSA B651
- OBC

KOHLER® Faucet Lifetime Limited Warranty

See website for detailed warranty information.

Available Colors/Finishes

Color tiles intended for reference only.

Color	Code	Description
	CP	Polished Chrome
	BN	Vibrant® Brushed Nickel
	BL	Matte Black
	2MB	Vibrant® Brushed Moderne Brass
	BMB	Matte Black with Moderne Brass

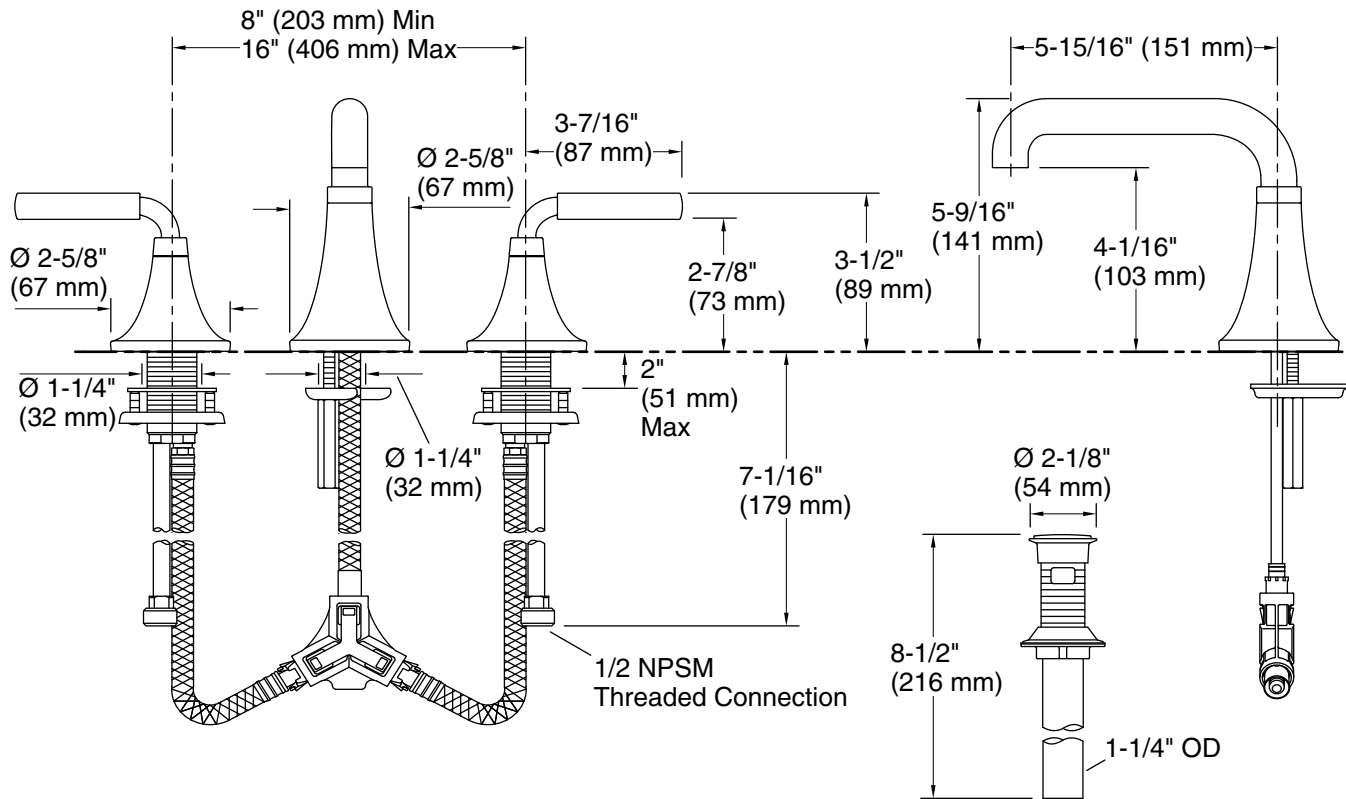

Technical Information

All product dimensions are nominal.

Faucet flow rate: 1.2 gal/min (4.5 l/min)

Drain included: Yes

Drain tailpiece included: Yes

Spout:

Spout reach: 5-15/16" (151 mm)

Notes

Install this product according to the installation instructions.

ADA, OBC, CSA B651 compliant when installed to the specific requirements of these regulations.