

USE AND CARE GUIDE

Item No.: HF42408AA-EU

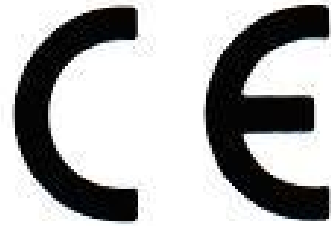
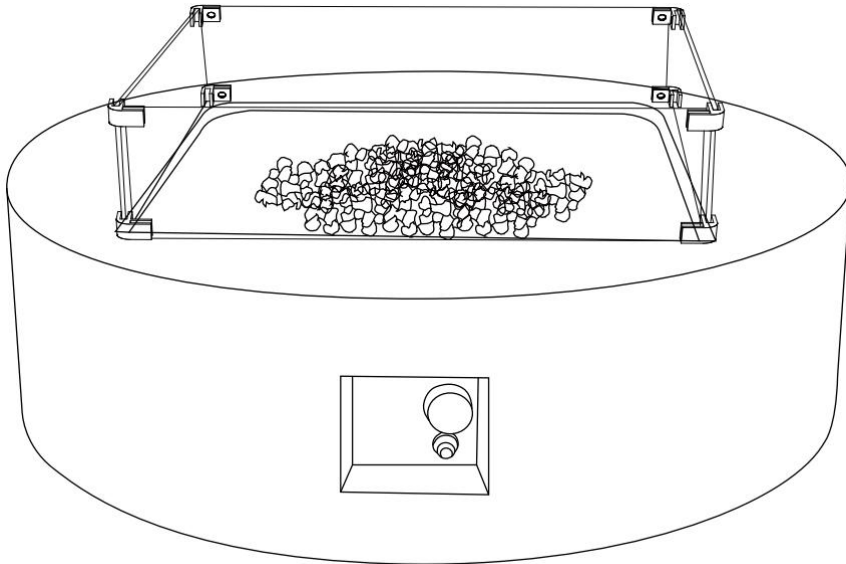

0359-17

0359CS02874

This appliance is intended for decorative purposes

Warning: For Outdoor use only!

Not for domestic use!

Keep the instruction for future reference!

**“These instructions are only valid if the country symbol appears on the instruction manual
and on the appliance”**



WARNING:

- Do not modify the appliance;
- Do not move the appliance during use;
- Turn off the gas supply at the gas container after use
- Accessible parts may be very hot. Keep young children away
- The appliance should not be used in basements or below ground level.
- The appliance must only be used for space heating.



WARNING:

THIS APPLIANCE HAS A NAKED FLAME; A SUITABLE GUARD SHOULD BE USED FOR THE PROTECTION OF YOUNG CHILDREN, THE ELDERLY AND THE INFIRM.



DANGER



CARBON MONOXIDE HAZARD

This appliance can produce carbon monoxide which has no odor.

Using it in an enclosed space can kill you.

Never use this appliance in an enclosed space such as a camper, tent, car or home.

INDEX

Specification	Page 3
Gas Fire pit Safety Warnings	Page 4
Liquid propane gas warnings	Page 7
Expanded View	Page 9
Installation	Page 10
Set up	Page 11
Connecting gas circuit to LPG cylinder	Page 12
Operating Instructions	Page 13
Leakage Testing	Page 14
Maintenance and Cleaning	Page 15
Storage (after use)	Page 16
Troubleshooting	Page 17

SPECIFICATION

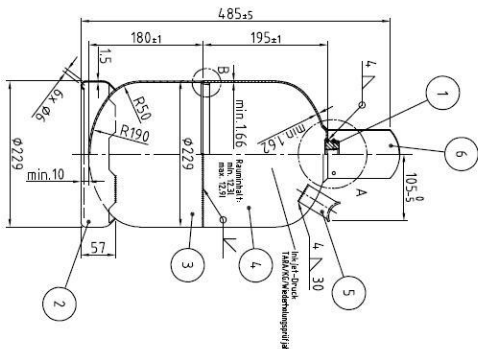
Product Name	Gas Fire pit			
Model	HF42408AA			
Gas Type	Butane at (28~30)mbar/ Propane at 37mbar	LPG gas mixture	LPG gas mixture	LPG gas mixture
Gas Category	I ₃₊ (28-30/37)	I _{3B/P} (30)	I _{3B/P} (37)	I _{3B/P} (50)
Heat input (Hs)	13 kW(946.4g/h)	13 kW(946.4g/h)	13 kW(946.4g/h)	13 kW(946.4g/h)
Gas pressure	G30 at 28-30mbar G31 at 37mbar	G30/G31 at 30mbar	G30/G31 at 37mbar	G30/G31 at 50mbar
Injector diameter (Ø) and No.	1.84 mm	1.84 mm	1.74 mm	1.59mm
Destination countries	GB,BE,CY,CZ,FR,GR,IE,IT,LV,LT,LU,PT, SK,SI,ES,CH	AL,BE,BG,CY,H R,DK,EE,FI,FR,HU,IS,IT,LT,LU,MT,MK,NL,NO,RO,SK,SI,SE,TR	PL	AT, DE, SK,CH,
Gas regulator	Certified regulator according to EN 12864 (flow rate: max. 1.5kg/h)			
Gas hose	Certified gas hose according to applicable EN-standard (max3.0m)			
Gas cylinder	Standard gas cylinder (recommend to use 4.5kg ~ 15kg)			
				
Primary air regulation	Fix - not adjustable			
Appliance mass:	50 kg			

This symbol is stick on in the higher part of the appliance (do not remove it).

**Attention:
Surface very hot!
Do not touch!!!!**



ATTENTION: This appliance is fitted with flexible gas rubber pipe and clamps that must be used; never use different kind and always according to the National Rules in force of the country of destination.

These components should be periodically substituted, according to the date reported on the body of each of them, or according to the National Rules in force of the country of destination.

Gas regulator and LPG cylinder are not included and have to be bought according to LPG compartment shape and cylinder support.

GAS FIREPIT SAFETY WARNINGS



WARNING:

Failure to heed the Dangers, Warnings and cautions contained in this Owner's Manual may result in a serious explosion causing damage to property, bodily injury.

GENERAL WARNINGS

FOR OUTDOOR USE ONLY--DO NOT OR STAND ON TABLE

Warning -For your safety

- If the information in this manual is not followed exactly, a fire or explosion may result causing property damage, personal injury or loss of life.
- **IMPORTANT NOTICE:** read and understand all warnings and precautions prior to assembly and use for you gas fireplace.
- **DANGER: Failure to follow the dangers, warning and cautions in this manual may cause a fire or explosion causing damage to property, serious bodily injury or death.**
- Minimum Clearance From Unit To Combustible Material:
72" (182.9cm) from the top; 36" (91.5cm) from all sides and back.

Do not locate this appliance under over-head unprotected combustible surfaces.

IF YOU SMELL GAS:

- 1. Shut off gas supply to the fireplace.**
 - 2. Extinguish any open flame.**
 - 3. Do not try lighting any appliance.**
 - 4. Do not touch any electrical switch nor use any phone in your building.**
 - 5. Immediately call your gas supplier from a neighbor's phone.**
 - 6. Follow the gas supplier's instructions.**
 - 7. If you cannot reach your gas supplier, call the fire department.**
- Never Improper installation, adjustment, alteration, service or maintenance can cause injury or property damage. Read the installation, operation and maintenance instructions thoroughly before installing or servicing this equipment.
 - Keep these instructions for future reference. If you are assembling this unit for some-one else, give this manual to him or her to read and keep for future reference.
 - This gas fireplace should ONLY be used outdoors in a well-ventilated space and should NOT be used inside a building, garage, or any other enclosed area.
 - Do NOT use this outdoor gas fireplace for indoor heating. TOXIC carbon monoxide fumes can accumulate and cause asphyxiation.
 - Never LEAVE this gas fireplace unattended when in use.
 - Children and adults should be alerted to the hazards of high surface temperatures and kept at a safe distance while fireplace is in use.
 - Do NOT operate light or use this fireplace within 8 feet of walls, structures or buildings.
 - Storage of this fireplace indoors is permissible only if it has been disconnected from its fuel supply (LP gas

cylinder).

- Gloves are strictly recommended to be used while moving this appliance, to protect your hands.
- Any sealed parts by Manufacture or his agent can not be altered by the user
- Do not store or use gasoline or other flammable vapors and liquids within 25 feet (7.62m) of this or any other appliance.
- Do NOT store any combustible materials in the base enclosure.
- The use of alcohol, prescription or non-prescription drugs may impair an individual's ability to properly assemble or safely operate this fireplace.
- Do not use in an explosive atmosphere. Keep gas fireplace area clear and free from combustible materials, gasoline and other flammable vapors and liquids.
- This outdoor fireplace is NOT to be operated by children. Young children should be closely supervised when in the vicinity of this outdoor fireplace.
- This outdoor fireplace is not to be installed or used in or on recreation vehicles and/or boats.
- Always use in accordance with all applicable local, state and national codes. Contact your local fire department for details on outdoor fires.
- Use the same precautions you would with any open fire with this outdoor fireplace.
- Do NOT burn solid fuels such as: wood, charcoal briquettes, lump charcoal, manufactured logs, driftwood, trash, leaves, paper, cardboard, plywood, painted or stained or pressure treated wood in this outdoor fireplace.
- Do NOT alter this outdoor fireplace in any manner.
- Do NOT use this outdoor fireplace until it is COMPLETELY assembled and all parts are securely fastened and tightened.
- Do NOT store another LP gas tank within 10 feet (3.05 m) of this outdoor fireplace while it is in operation.
- Do NOT use this outdoor fireplace near automobiles, trucks, vans or recreational vehicles.
- Do NOT use this outdoor fireplace under any overhead or near any unprotected combustible materials. Avoid using near or under overhanging trees and shrubs.
- Always use this outdoor fireplace on a hard, level, non-combustible surface such a concrete, rock or stone. An asphalt or blacktop surface may not be acceptable for this purpose.
- Do NOT use this outdoor fireplace if any part has been under water. Immediately call a qualified service technician to inspect the fireplace and to replace any part or control system and any gas control which has been under water.
- Do NOT wear flammable or loose clothing when operating this outdoor fireplace.
- Do NOT use in windy conditions.
- Keep all electrical cords away from a hot outdoor fireplace.
- Certain areas of this outdoor fireplace will become too hot to touch during and after use . Do not touch hot surfaces until the unit has cooled unless you are wearing protective gear such as insulated pot holders or heat resistant gloves or mittens to avoid burns.
- Children and adults should be alerted to the hazards of high surface temperatures and should stay away to avoid burns or clothing ignition.
- Do NOT hang or place clothing or other flammable materials on or near the gas fire-place.
- Any guard or other protective device removed for servicing the fireplace must be re-placed prior to operation.

-
- Do NOT attempt to move or store this outdoor fireplace until all parts are cool.
 - Do NOT lean over this outdoor fireplace when lighting or when in use.
 - Use only the regulator and hose assembly provided. Use only replacement regulator and hose assemblies specified by the manufacturer.
 - Storage of this outdoor fireplace indoors is permissible only if the tank is disconnected, removed from the outdoor fireplace and properly stored outdoors.
 - Do not attempt to disconnect the gas regulator from the tank or any gas fitting while the outdoor fireplace is in use.
 - Always shut off gas supply at the tank valve and disconnect regulator from the tank when the fireplace is not in use.
 - Do NOT sit on the mantle when the unit is in operation.
 - Do not throw anything onto the fire when the unit is in operation.
 - Lava rocks are very hot; please keep children or pets away at a safe distance.
 - It is essential to keep the outdoor fireplace valve compartment, burners, and circulating air passages clean. Inspect outdoor fireplace for debris before each use.
 - Prior to each gas fireplace operation, check the hose for evidence of excessive abrasion or wear by looking through the visual check hole. If the hose is damaged, cut or cracked, it must be replaced before using the gas fireplace. The hose assembly can only be replaced by a hose assembly specified by the manufacturer.
 - Before each use, remove the lava rocks. Examine the burner and its components. If dirty, clean with a soft brush and soapy water solution. Also examine the area around the burner. Any dirt or foreign material, such as spider webs or nests in this area should be removed. If it is evident that the burner is damaged, it must be replaced before the gas fireplace is used.
 - The burner assembly can only be replaced by a burner specified by the manufacturer. Place the hose out of the pathways where people may trip over it.
 - Do Not cross the hose between outdoor fireplace and the propane tank.
 - **Before installation, ensure that the local distribution conditions (identification of the type of gas and pressure) and the adjustment of the appliance are compatible.**
 - **the appliance shall be connected in accordance with national regulations.**
 - **any air supply shall be in accordance with national regulations.**
 - **WARNING: When the national conditions require it, it's necessary to change the flexible tube.**

LIQUID PROPANE GAS (LPG) WARNINGS

- LP gas is flammable and hazardous if handled improperly. Please review the characteristics before using any LP gas product.
- Propane Characteristics:
- Flammable, explosive under pressure, heavier than air, and settles in pools in low areas. In its natural state, propane has no odor. For your safety, an odorant is typically added. Contact with propane could burn the skin.
- Propane is extremely flammable and hazardous if handled improperly.

LP GAS WARNINGS:

- Cylinders must be stored outdoors in a well-ventilated area out of reach of children.
- Disconnected cylinders must have threaded valve plugs tightly installed and must
- not be in a building, garage or any other enclosed area.
- Never use a propane cylinder with a damaged body, valve, collar or footing.
- Dented or rusted propane cylinders may be hazardous and should be checked by your propane gas supplier.
- LP gas tank must be arranged for vapor withdrawal.
- The LP gas tank must have a tank collar to protect the tank valve.
- Never use an LP gas tank with a damaged body, valve, collar, or footing. Dented or rusted LP gas tanks may be hazardous and should be checked by your LP gas supplier prior to use.
- The LP gas tank should not be dropped or handled roughly.
- Tanks must be stored outdoors out of the reach of children. Do NOT store in a building, garage, or any other enclosed area.
- Never store your LP gas tank where temperatures can reach over 125°F.
- Do not store the LP gas cylinder in direct sunlight or near a source of heat or combustion.
- Never keep a filled LP gas tank in a hot car or car trunk. Heat will cause the gas pressure to increase, which may open the relief valve and allow gas to escape.
- Place dust cap on valve outlet whenever the LP gas tank is not in use. Only install the type of dust cap on the LP gas tank valve outlet that is provided with the LP gas tank valve. Other types of caps or plugs may result in leakage of propane.
- Do not store a spare LP gas cylinder under or near this appliance.
- Never fill the LP gas cylinder beyond 80% full.
- If the information in (a) and (b) is not followed exactly, a fire causing death or serious injury may occur.
- LP gas cylinders should be filled only by a certified LP gas dealer.
- the pressure regulator is set for the gas pressure of the local state
- Regulator outlet pressure is in line with the gas pressure of the local state.
- Never attempt to attach this appliance to the self-contained LP gas system of a camper trailer, motor home or house.

-
- Always use the pressure regulator and hose assembly provided with the appliance to connect to a LP gas cylinder. Never connect to an unregulated LP gas supply.
 - Contact your retailer's customer service department for replacement parts.
 - Hand turn the manual gas control valve. Never use tools. If the valve will not turn by hand, do not try to repair it. Call a certified gas technician. The use of force or any self attempted repair may result in a fire or explosion.
 - Use only the type of gas and the type of LPG cylinder specified by the manufacturer.
 - Appliance is fitted with gas regulator, flexible gas rubber pipe and clamps according to the National Rules in force of the country of destination.
 - Appliance must use an approved gas regulator (approved for a working temperature not lower than 50 °C) according to the EN Standard (see minimum, nominal and maximum pressure on page 11 - gas regulator inlet and outlet connection according to the National Rules in force) and flexible gas rubber pipe according to EN 16436-1 (with proper inner diameter according to gas inlet connection and National Rules in force) with a length not over 3.0 m and approved for a working temperature not lower than 60 °C. When substitution will be necessary, you have to purchase suitable gas regulator, flexible gas rubber pipe and clamps from your local gas dealer; gas regulator should be substituted not over 10 years.
 - Flexible gas rubber pipe must be carefully , avoiding any twisting. Never use a damaged gas regulator.
 - Never connect this appliance to an unregulated LPG source (gas regulator is mandatory to be used).
 - When the appliance is not in use, turn the LPG cylinder in "OFF" position.
 - Always perform a leakage test on gas connections whenever a LPG cylinder is connected. If bubbles form in Flexible gas rubber pipe must be located in the LPG compartment carefully, avoiding any twisting.
 - Never use a damaged gas regulator.
 - Always perform a leakage test on gas connections whenever a LPG cylinder is connected. If bubbles form in the leakage test solution, do not use it. Never use a flame to test for leakages. **It is strictly forbidden and dangerous!**
 - to change the gas cylinder in a amply ventilated area, away from any ignition source.
 - The tanker is away form the fireplace 60 inch.(see below picture).

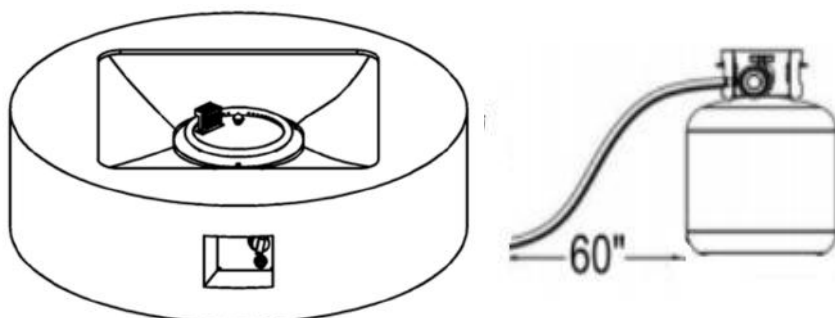

EXPANDED VIEW

ITEM	SPECIFICATION	QTY
1	Body	1
2	Lava rocks	1
3	Burner	1
4	Firebowl pan	1
5	Ignition pin	1
6	Thermocouple	1
7	Corrugated pipe	1
8	Injector	1
9	Gas valve	1
10	Control knob	1
11	Pulse ignition	1
12	Regulator	1
13	Ignition Screen	1
14	Grounding wire	1

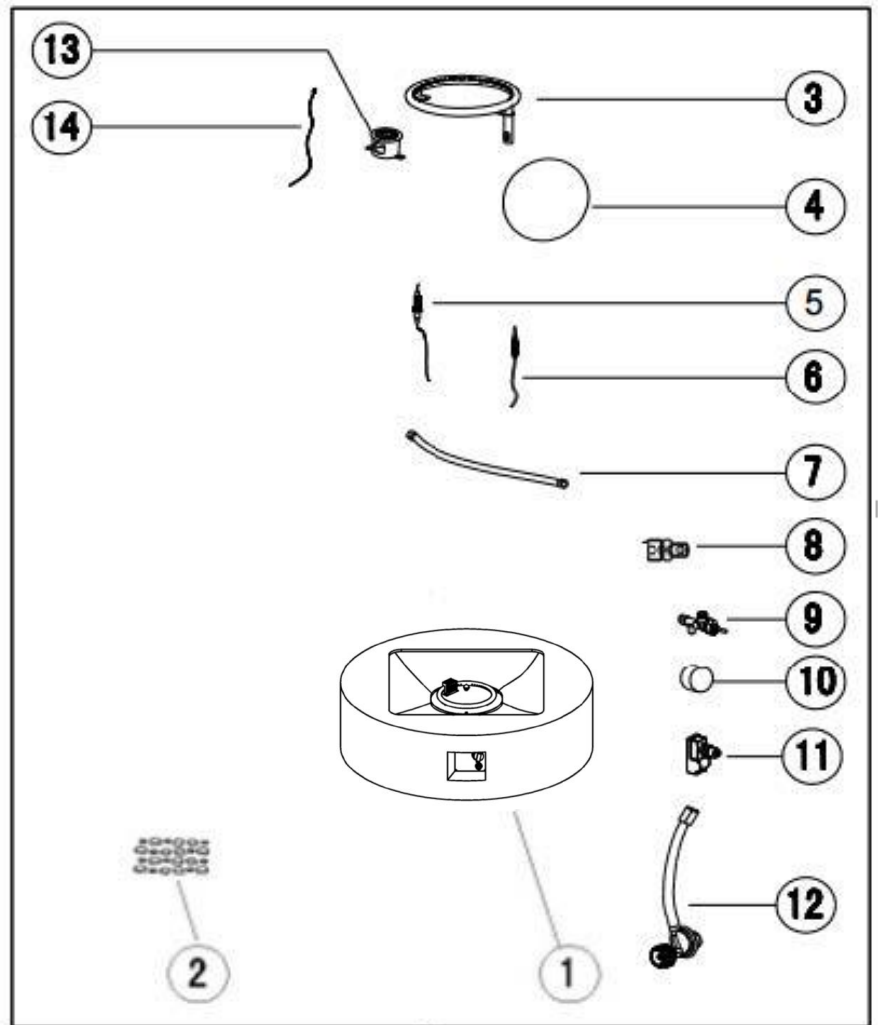





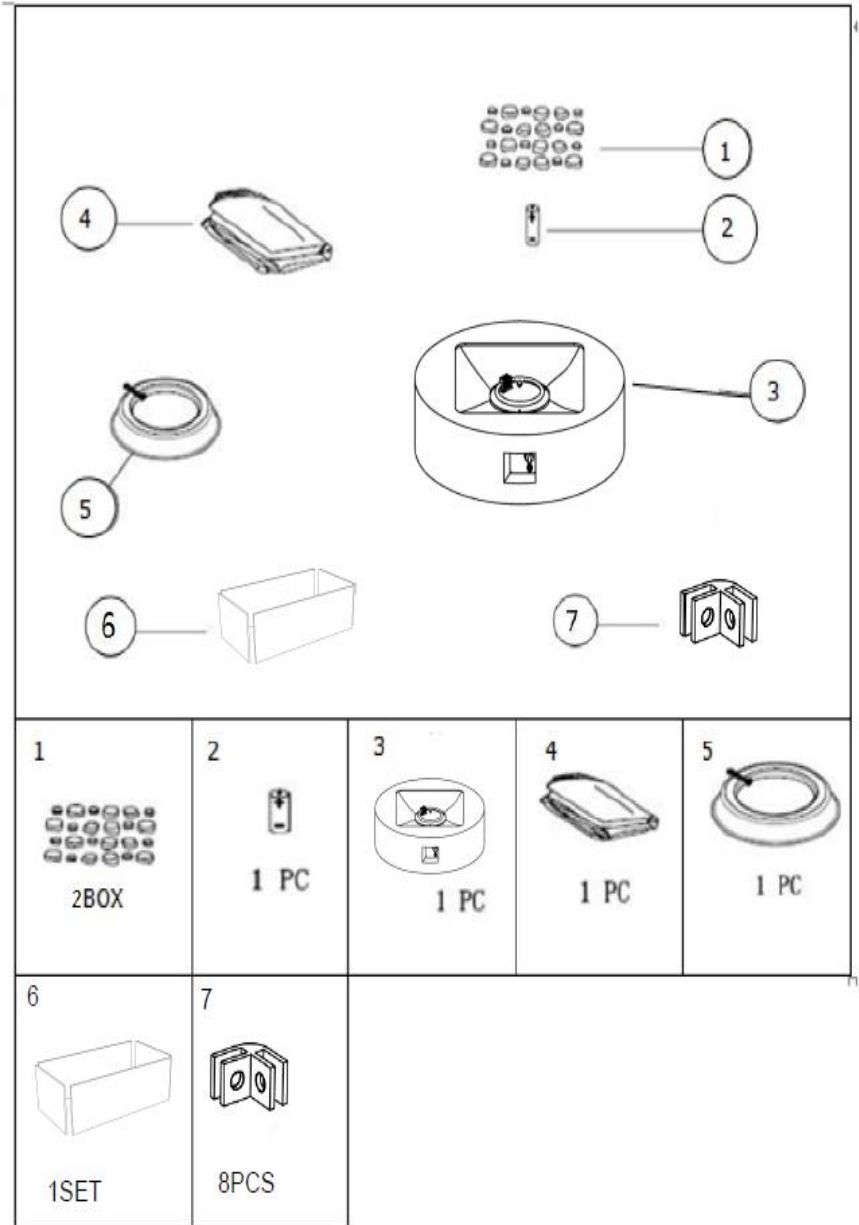

INSTALLATION

Packed components list

ITEM	DESCRIPTION	QTY
1	Lava Rocks	2 BOX
2	Battery(AAA)	1PC
3	Body	1PC
4	PVC Cover	1PC
5	Tank Scat	1PC
6	Glass	1SET
7	Michel's Clip	8PCS



1  2BOX	2  1 PC	3  1 PC	4  1 PC	5  1 PC
6  1SET	7  8PCS			

ASSEMBLY INSTRUCTIONS

* Please keep these owner's manual for future reference.

*If you have opened the carton and removed all packages, please disregard the STEP 1 and 2. See the STEP 3 directly.

STEP 1. (1) Open the carton and turn it upside down, make sure the 5 pieces of the carton being open up.
 (2) Lift off the carton carefully and be wary of the accessories inside falling away.
 (3) Take all the packing materials away except for the paper honeycomb board rounding the top of the firebowl.

STEP 2. (1) Turn the firebowl heads up on a flat ground.
 (2) Remove all the paper honeycomb board rounding the top of the firebowl.

STEP 3.

(I) Check each part before using the product. Make sure the gas supply system is turned "OFF" before assembling. See Figure A.

(II) Locate the battery, remove the plastic cover first. Unscrew the rubber cap of the Electric Ignitor, place a AAA battery into the battery case. Make sure the positive pole ("+") towards the cap. Screw the cap back to the battery case tightly. See Figure B.

(III) Place the lava rock averagely in the fire bowl on the top of the firebowl. See Figure C.

** DO NOT COVER THE IGNITION SCREEN when placing the lava rock into the fire bowl. Always keep Ignition SCREEN visible.

** Connect the Pressure-Regulating Valve to the gas tank. See Figure D.

1) Turn the cylinder valve clockwise to close the gas supply on the gas tank.

2) Screw Regulator Coupling clockwise by hand only. Make sure it is fastened.

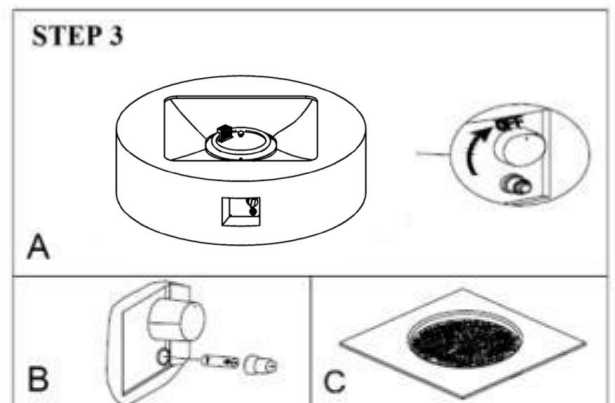

See **WARNING** and Figures:

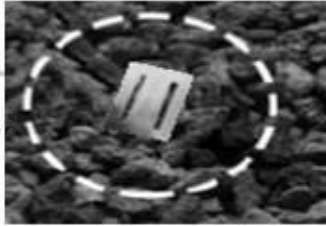
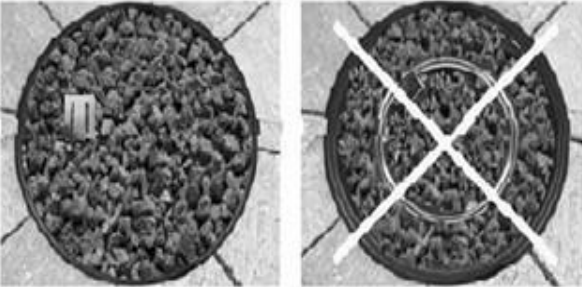
<p>▲ WARNING</p>	<p>Screen</p> 
<p>This screen must be clear and free of obstructions at all times to insure proper operation.</p>	<p>DO NOT PLACE LAVA ROCKS ON THE SCREEN. KEEP SCREEN CLEAR</p>
<p>▲ WARNING</p> <p>The burner of the firebowl must be covered by lava rocks completely. Otherwise the flame may be extinguished. See the Figure for the CORRECT and INCORRECT ways for reference.</p>	 <p>CORRECT INCORRECT</p>

Perform leak test in a well ventilated area outside and where no source of spark can occur.

Remove battery from igniter. Open tank valve fully (counter-clockwise). Turn the on/off valve at the unit to the 'off' position to pressurize the hose assembly. Use a soapy water solution to check all the connections leaks before attempting to light the appliance. **If a leak is found, turn the tank valve off and do not use the appliance until repairs can be made.**

- TIPS: Before Starting
- Read the instructions thoroughly.
 - Check and make sure that all parts are present.
 - For future reference, save this instruction manual.

TO LIGHT

Before each use, inspect the hose. Replace hose if there are any signs of cutting, wear or abrasion.

- (1) Turn the cylinder valve on the gas tank counter-clockwise to open the gas supply.
- (2) Close the storing door on the fire bowl for the gas tank.
- (3) Light the fire bowl as below steps:

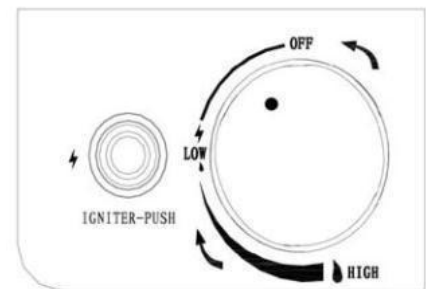

- A. Press and hold the Electric Igniter. Meanwhile, push and turn the Control Knob counter-clockwise to the "LOW" position. Keep pushing the Control Knob to light the burner .
- B. After ignition, release the Electric Igniter. Continue to push and hold the Control Knob for 45 seconds.
- C. If ignition does NOT immediately take place in seconds, push and turn the Control Knob clockwise to "OFF". Wait 5 minutes, then repeat the lighting procedure as above.

Caution: *If the burner does not ignite with the valve open, gas will continue to flow out of the burner and could accidentally



ignite with risk of injury.

Observe flame height when lit:

Flame should possibly be a yellow/blue color between 2 to 10 inches high.

TO EXTINGUISH

To turn "OFF" (full disk) the appliance

1. Turn appliance control knob clockwise up to "OFF" position (full disk).
2. Turn the LPG cylinder valve to the "OFF" position.
3. Allow the appliance to cool before moving it (at least 30 minutes).

Re-Lighting

1. Turn control knob to "OFF" position.
2. Wait at least 5 minutes, to let gas dissipate, before attempting burner re-light.
3. Repeat the "Lighting" steps.

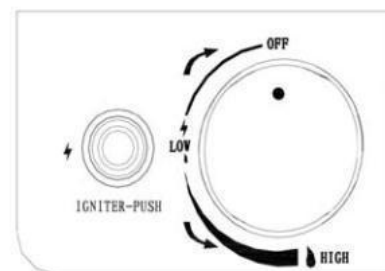

LEAKAGE TESTING

Never check for gas leakages with a flame or while smoking.

This appliance needs to be periodically checked for leakages and an immediate check is required if the smell of gas is detected.

- Make a soap solution using 1 part of liquid dish-washing soap to 3 parts water. The soap solution can be applied with a soap bottle, brush, or rag to the leakage tested points shown in the figure beside.
- The valve of the LPG cylinder should be in the "OFF" position at this point of the leakage test. Once the soapy solution is applied to the gas connections, the valve of the LPG cylinder needs to be turned to the "ON" position.
- Soap bubbles will begin to form in the soapy solution if any leakage is present.
- In the event of gas leakage, the appliance shall not be used or if alight, the gas supply shall be shut-off and the appliance shall be investigated and rectified before it is used again. Tighten any leaking fittings, then turn on gas supply and recheck.
- If necessary, substitute gasket (according to EN 549 Class B2) or material used to guarantee tightness (according to EN 751-1 Class I).

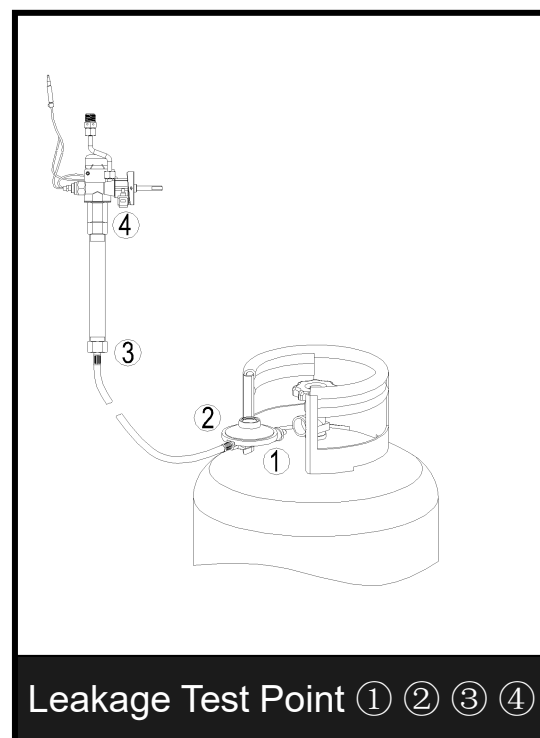

MAINTENANCE AND CLEANING

To enjoy years of outstanding performance from your appliance, regular services of the appliance is mandatory as followings:

- The appliance should be inspected before at least one time a year by a Qualified Service only. More frequent cleaning may be required according to the use of the appliance.
- Any guard or other protective device removed for servicing the appliance must be replaced before operating it.
- Keep exterior surfaces clean, free and clear from combustible materials.
- Use warm soapy water for cleaning. Never use flammable or corrosive cleaning agents.
- While washing your unit makes sure to keep the area around the burner assembly dry at all times. If the gas control is exposed to water in any way, **DO NOT** tries to use it. It must be replaced.
- Burner and LPG compartment circulating air passageways of the appliance must be kept clean.
- Airflow must be unobstructed. Keep controls, burner and circulation air passageways clean. Signs of possible blockage include:
 - Gas odor with extreme yellow tipping of flame / Appliance glow is excessively uneven / Appliance makes popping noises.
 - Spiders and insects can nest in burner or orifices. This dangerous condition can damage the appliance and render it unsafe for use. Clean burner holes by using a heavy duty pipe cleaner. Compressed air may help clear away smaller particles.
 - Carbon deposits may create a fire hazard. If any carbon deposits develop, clean dome and engine with warm soapy water.
 - After the burner and lava rocks are completely cooled down, remove it from the bowl and use a soft brush to get rid of the mild stains, loose dirt and soil. Wipe with a soft cloth.
 - Clean the bowl and afterward put lava rocks again in proper position.
 - For proper cleaning, a vacuum cleaner can be used.

Note: In a salt-air environment (such as near the sea), corrosion occurs more quickly than normal. Frequently check the corroded areas and repair them promptly. Stubborn stains, discoloration and possibly rust pitting can occur from exposure to harsh outdoor conditions. Be careful not let any powder or solvent come in contact with painted or plastic components as damage may occur.

After long use, some discoloration can come up and it screen is normal.

Make sure both gas supplies is in OFF position before changing battery. Please refer to the process of assembling battery.

Please contact the Manufacturer or dealer for information regarding replacement hoses, thermocouples, igniters, lava rocks, etc.

Attention: Never use unauthorized parts or component for this appliance.

Use only original equipment replacement spare parts and components.

Otherwise may void the warranty of this product and result in a hazardous condition.

STORAGE (after use)

Turn control knob in "OFF" position (full disk).

Turn LPG cylinder in "OFF" position.

Store the appliance in a cool dry place away from direct sunlight; store it upright in an area sheltered from direct contact with inclement weather (such as rain, sleet, hail, snow, dust and debris).

If desired, cover to protect exterior surfaces and to prevent build up in air passages.

Note: Wait until appliance is cool before covering.

During periods of extended inactivity or when transporting:

Turn control knob in "OFF" position (full disk).

Disconnect LPG cylinder and move to a secure, well ventilated location outdoors. DO NOT store in a location that will exceed 50 °C.

Store appliance upright in an area sheltered from direct contact with inclement weather (such as rain, sleet, hail, snow, dust and debris).

If desired, cover appliance to protect exterior surfaces and to prevent build up in air passages.

Note: Wait until appliance is cool before covering.

TROUBLESHOOTING

Problem:	Condition:	Solution suggested:
Burner won't light	Control knob is not in Maximum position (big flame).	Turn control knob in Maximum position (big flame).
	LPG cylinder valve is closed / Empty.	Open the valve / Replace LPG cylinder with a new one.
	Blockage in the injector.	Clean or replace injector.
	Air in the gas circuit.	Open gas line and bleed it (pressing control knob in) for not over 1 minute or until you smell gas.
	Low gas pressure.	Replace LPG cylinder with a new one.
	Igniter fails.	Use match to light burner; change battery or obtain new igniter and replace it.
Burner won't stay lit	Dirty build up around burner.	Clean dirty around the burner.
	Low flames or not full running around the burner.	Flame spreader holes partially closed; clean the burner.
	Thermocouple is not operating correctly.	Replace thermocouple (FSD).
	Low Gas pressure.	Replace LPG cylinder with a new one.
Burner flame is low Note: Do not operate appliance below 5 °C	Outdoor temperature is greater than 5 °C and LPG cylinder is less than 25 % full.	Replace LPG cylinder with a new one.
	Gas pipe is bent or kinked.	Straighten hose and perform leakage test on gas pipe.
	Control knob is fully Maximum position (big flame).	Turn control knob to "OFF" position (full disk), let cool to room temperature and check burner and orifices for blockage.
Carbon build-up	Dirty or film on burner.	Clean burner.
Flash back (flame inside burner)	Burner ports are blocked.	Switch OFF the appliance. Close LPG cylinder valve. Wait 2 minutes, following the ignition procedure. Ignite burner. If problem continuous, switch-off. Contact your dealer.
Thick black smoke	Blockage in the burner.	Turn control knob to "OFF" position, let the appliance to cool at room temperature and remove blockage and clean burner inside and outside.

If you can not solve trouble according to one of the mentioned solution, please call the 49(0)6074-8931-13 or contact your dealer or Distributor Responsible.

Helpful Tips

If the burner will not light or stay lit, please perform the following checks.

It is possible that the Excess Flow Safety Device has been tripped.

Turn the control knob to off and close the LP Gas tank valve. Disconnect the regulator. Turn the Control Knob to “HIGH”. Wait a minimum of 5 minutes. Turn burner control knob back to “OFF”. Reconnect the regulator and perform a leak check at tank connection. Turn the LP Gas tank valve on slowly, wait 30 seconds and then light the outdoor fire table.

To ensure proper ignition make sure the igniter pin is properly positioned and connected.

- The igniter pin should be pointed straight to the thermocouple.
- The thermocouple should be positioned 5mm away from the burner tube.

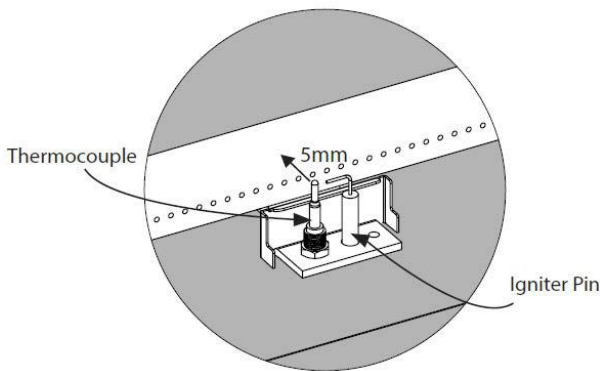

If wires are too close, or tangled, they could short. Make sure they are spaced apart from each other.

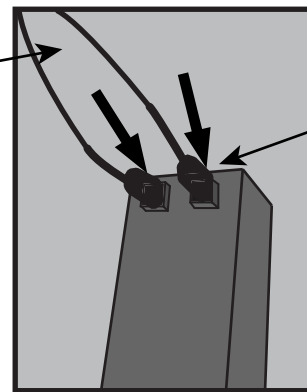

Make sure the wires are fully inserted into the ignitor box.

Make sure that the pilot housing is unobstructed.

Clear any debris on top of the pilot housing and make sure there is no debris between the igniter pin, thermocouple and the burner tube.

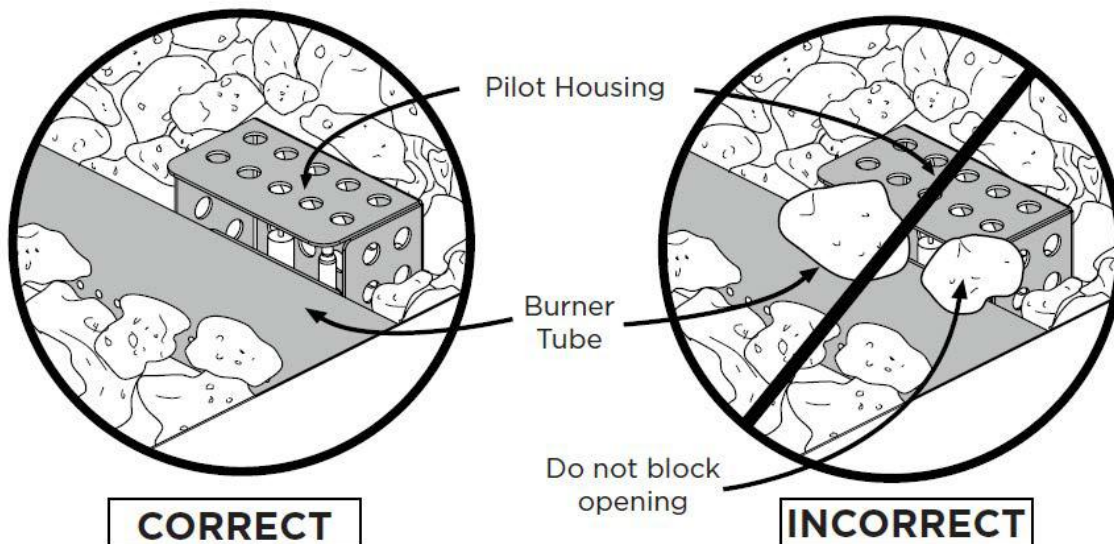

Troubleshooting

Problem: Burner will not light using igniter

Please review the Helpful Tips for common fixes to this problem.

Possible Cause 1: Electrode and burners are wet.

-Wipe dry with cloth.

Possible Cause 2: Igniter battery is dead or backwards.

-Check that the AAA battery is inserted correctly in the igniter (see page 10) or replace the battery. Make sure the plastic wrap on the battery has been removed.

Possible Cause 3: Igniter Pin cracked or broken - sparks at crack.

-PLS contact retailer for technical support.

Possible Cause 4: Bad Igniter

-PLS contact retailer for technical support.

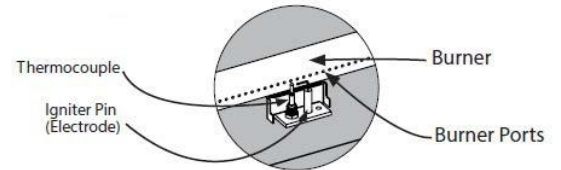

Problem: Burner will not light with match

Possible Cause 1: No Gas Flow

-Check if the LP gas tank is empty. If empty, replace and refill. If the propane tank is not empty, refer to “Problem: Sudden drop in gas flow” on the following page.

Possible Cause 2: Coupling nut and regulator not fully connected.

-Turn the coupling nut about one half to three fourths a turn, until you feel a solid stop. Do not use tools, tighten by hand only.

Possible Cause 3: Obstruction of gas flow.

- Check for bent or kinked hose.

Possible Cause 4: Spider webs or insect nest in the venturi.

- Clean the venturi.

Possible Cause 5: Burner ports clogged or blocked.

-Reference “Problem: Irregular flame pattern” on the following page. Clean the burner ports as described there.

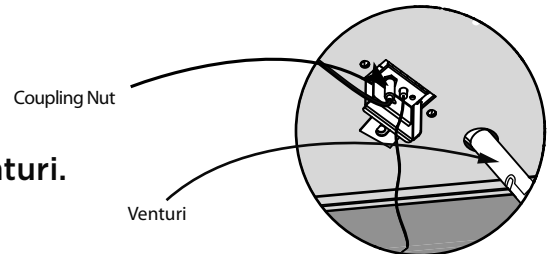

Problem: The fireplace emits a lot of black smoke when in use

Possible Cause 1: Hose from gas fireplace is pinched.

-Make sure the hose is not pinched between the fire table and the source of the gas.

Possible Cause 2: Flame is being obstructed at burner ports.

-Make sure that the gas ports on the burner are free of any lava rocks/fire glass so that the flame can flow naturally.

Possible Cause 3: Mixing chamber of the burn tube is blocked or obstructed.

-Clear out the mixing chamber located before the Venturi.

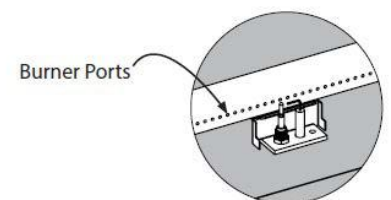

Troubleshooting

Problem: Sudden drop in gas flow, or a reduced flame height

Possible Cause 1: Out of Gas.

-Check for gas in the LP gas tank.

Possible Cause 2: Excess flow safety device may have been activated.

-Turn control knob to “OFF”, wait 30 seconds and light outdoor fire table. If flames are still too low, reset the excessive flow safety device by turning off the control knob and LP gas tank valve. Disconnect regulator. Turn burner control knob to “HIGH”. Wait at least 5 minutes. Turn burner control knob off. Reconnect regulator and perform a leak check at tank connection. Turn LP gas tank valve on slowly, wait 30 seconds and then light outdoor fire table.

Problem: Irregular flame pattern, flame does not run the full length of the burner

Possible Cause: Burner ports are clogged or blocked.

-Clean burner ports. Do this by inserting a paperclip into each of the burner ports to ensure they are not clogged.
WARNING: Make sure burner is not on, and has had sufficient time to cool before touching it.

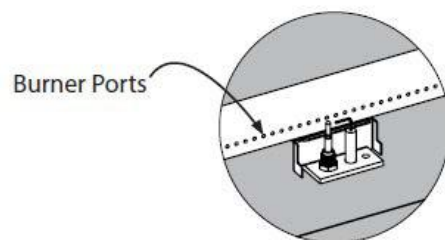

Problem: Flame blow out

Possible Cause 1: High or gusting winds.

-Increase flame to “HIGH” setting.

Possible Cause 2: Low on LP gas.

-Replace or refill LP gas tank.

Possible Cause 3: Excess flow valve tripped.

-Refer to “Problem: Sudden drop in gas flow”

Problem: Flame seems to lose heat when burning in cold weather - temperature below 50°F

Possible Cause 1: Ice has built up on the outside of the LP gas tank because the vaporization process is too low.

-Turn the control knob and the LP gas tank to “OFF”. Replace with a spare LP gas tank and resume burning. Store the spare LP gas tank in a well ventilated area, away from children.

If these trouble shooting steps are unable to resolve the problem. PLS contact customer service for technical support.



+44(0) 1952 916050
9am-5pm EST, Mon-Fri



sales@teamson.co.uk

Assembly

1 Assembling the glass

Unscrew all preassembled screws on the glass clamps (F). Then, assemble one short glass panel (G) to one long glass panel (H). Repeat for the other short glass panel (G) and long glass panel (H). Then, assemble the two glass panel pieces together with the final two glass clamps (F) as shown below.

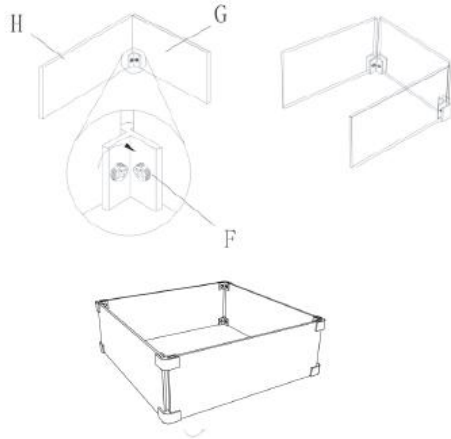

2 Inserting the glass

Insert the glass assembly made in step 2 into the ridge on the top of the fire table body (C).

